

★

SYSTEM MANUAL

U.S. NAVY
TRANSPORTABLE
COMMUNICATION SYSTEM
AN/TSC-35

VOLUME I OF III
GENERAL DESCRIPTION



Prepared by

T. M. C. SYSTEMS, INC.
ALEXANDRIA VIRGINIA

A SUBSIDIARY OF
THE TECHNICAL MATERIEL CORPORATION
MAMARONECK, N. Y. OTTAWA, CANADA

LIST OF EFFECTIVE PAGES

PAGE NUMBERS	CHANGE IN EFFECT	PAGE NUMBERS	CHANGE IN EFFECT
VOLUME I			
Title	Original		
A	Original		
Record of Corrections Made	Original		
Safety Notice	Original		
i thru xxiv	Original		
1-1 thru 1-92	Original		
2-1 thru 2-18	Original		
VOLUME II			
Title	Original		
A	Original		
Record of Corrections Made	Original		
Safety Notice	Original		
i thru xii	Original		
1-1 thru 1-92	Original		
2-1 thru 2-49/2-50	Original		
3-1 thru 3-57/3-58	Original		
4-1 thru 4-167/4-168	Original		
VOLUME III			
Title	Original		
A	Original		
Record of Corrections Made	Original		
Safety Notice	Original		
i thru vi	Original		
1-1 thru 1-45/1-46	Original		
2-1 thru 2-51/2-52	Original		
3-1 thru 3-24/3-30	Original		

SAFETY NOTICE

The attention of officers and operating personnel is directed to Chapter 67 of the Bureau of Ships Manual or superseding instructions on the subject of radio-safety precautions to be observed.

This equipment employs voltages which are dangerous and may be fatal if contacted by operating personnel. Extreme caution should be exercised when working with the equipment.

While all practicable safety precautions have been incorporated in this equipment, the following rules must be strictly observed.

KEEP AWAY FROM LIVE CIRCUITS:

Operating personnel must at all times observe all safety regulations. Do not change tubes or make adjustments inside equipment with high voltage supply on. Under certain conditions, dangerous potentials may exist in circuits with power controls in the off position due to charges retained by capacitors. To avoid casualties, always remove power and discharge circuits prior to touching them.

DO NOT SERVICE OR ADJUST ALONE:

Under no circumstances should any person reach within or enter an enclosure for the purpose of servicing or adjusting the equipment without the immediate presence or assistance of another person capable of rendering aid.

DO NOT TAMPER WITH PROTECTIVE COVERS:

Panels of equipment carrying high voltages are fitted with doors or removable protective covers. Under no circumstance should any protective cover be removed, short-circuited, or tampered with in any way, by other than authorized maintenance personnel. All protective covers should be replaced immediately upon completion of the maintenance operation which required their removal.

RESUSCITATION

AN APPROVED POSTER ILLUSTRATING THE RULES FOR RESUSCITATION SHOULD BE PROMINENTLY DISPLAYED IN EACH ROOM. POSTERS MAY BE OBTAINED UPON REQUEST TO THE BUREAU OF MEDICINE AND SURGERY.

PREFACE

This manual, which consists of three volumes, covers the installation and operation of the U.S. Navy Transportable Communication System AN/TSC-35 (TMCS Model SYM-2005). The Communication System is comprised of a Receiving Central and a Transmitting Central.

Volume I covers a general description and the installation of the overall Communication System.

Volume II contains a detailed description of the Receiving Central components and describes the operation of the overall Communication System.

Volume III covers a detailed description and the operation of the Transmitting Central components.

VOLUME I
U. S. NAVY TRANSPORTABLE COMMUNICATIONS SYSTEM AN/TSC-35

TABLE OF CONTENTS

SECTION I—DESCRIPTION AND LEADING PARTICULARS		SECTION I—DESCRIPTION AND LEADING PARTICULARS (CONT)	
Paragraph	Page	Paragraph	Page
1-1	Introduction	1-1	1-36
1-2	Purpose	1-1	4944/TSR-1 (Container RE3)
1-3	Location	1-1	1-37
1-4	Transportability	1-1	Receiving Central Group AN/
1-5	Operational Capability	1-1	TSR-2 (Container RE4)
1-6	Relay Facilities	1-1	1-38
1-7	Receivers	1-1	Receiving Central Group OA-
1-8	Cryptographic Facilities.	1-1	4945/TSR-1 (Container RF1)
1-9	Terminal Equipment	1-1	1-39
1-10	Transmitters	1-2	Control Monitor Group OA-
1-11	Circuit-Programming	1-2	4950/TSR-1 (Container RF2)
	Facilities	1-2	1-40
1-12	Patching Facilities	1-2	Control Monitor Group OA-
1-13	Weather Facilities	1-2	4951/TSR-1 (Container RF3)
1-14	Multiplex Facilities	1-2	1-41
1-15	Facsimile	1-2	Receiving Central Group OA-
1-16	Primary Power Facilities	1-2	4966/TSR-1 (Container RG1)
1-17	Repair Facilities	1-2	1-42
1-18	Supply Facilities	1-3	Maintenance Equipment Group
1-19	Receiver Site Antenna	1-3	OA-4967/TSR-1 (Container
	Facilities	1-3	RH1)
1-20	Transmitter Site Antenna	1-3	1-43
	Facilities	1-3	Teletype Central AN/TGC-
1-21	General Description of	1-3	18 (Container RJ1)
	AN/TSC-35	1-3	1-44
1-22	Communication System AN/TSC-	1-4	Teletype Central AN/TGC-
	35 (SYM-2005-TR) Major	1-4	19 (Container RJ2)
	Components.	1-4	1-45
1-23	Description of Receiving Central	1-4	Power Distribution Group OA-
	AN/TSR-1 Containers	1-4	4968/TSQ-56 (Container GR1)
1-24	Receiving Central Group OA-	1-4	1-46
	3887/TSR-1 (Container RA1)	1-7	Power Control Group OA-
1-25	Receiving Central Group OA-	1-7	4969/TSQ-56 (Container GR2)
	4936/TSR-1 (Container RA2)	1-9	1-47
1-26	Receiving Central Group OA-	1-9	Generator Set, Diesel Engine
	7041/TSR-1 (Container RA3)	1-10	PU-600/TSQ (Containers GR3
1-28	Teletype Central AN/TGC-16	1-10	and GR6).
	(Container RB1)	1-10	1-48
1-29	Receiving Central Group OA-	1-11	Generator Set, Diesel Engine
	4937/TSR-1 (Container RB2)	1-11	PU-612/TSQ (Containers GR4
1-30	Receiving Central Group OA-	1-11	and GR5, "No-Break" Power)
	4938/TSR-1 (Container RB3)	1-11	1-49
1-31	Receiving Central Group OA-	1-11	Description of Transmitting
	4939/TSR-1 (Container RC1)	1-11	Central AN/TST-2 Containers
1-32	Maintenance Equipment Group	1-11	1-50
	OA-4941/TSR-1 (Container	1-11	Radio Transmitting Set AN/
	RD1)	1-11	TRT-17 (Containers TA1,
1-33	Supply Center OA-4942/TSR-	1-16	TA2, TB2, TB3, TC4, TD4
	1 (Container RD2).	1-16	and TG2).
1-34	Teletype Central AN/TGC-17	1-16	1-51
	(Container RE1)	1-16	Radio Transmitting Set AN/
1-35	Receiving Central Group OA-	1-16	TRT-23 (Container TA3).
	4943/TSR-1 (Container RE2)	1-16	1-52
		1-16	Radio Transmitting Set AN/
		1-16	TRT-18 (Containers TB1, TC2,
		1-16	TC3, TD2, TD3, TG3 and TH1
		1-16	1-53
		1-16	Control Monitor Group OA-
		1-16	4915/TST-2 (Container TC1)
		1-16	1-54
		1-16	Interconnect Group OA-4916/
		1-16	TST-2 (Container TD1)
		1-16	1-55
		1-16	Interconnect Group OA-4918/
		1-16	TST-2 (Container TG1)
		1-16	1-56
		1-16	Radio Transmitting Set AN/
		1-16	TRT-19 (Container TE1).
		1-16	1-57
		1-16	Maintenance Equipment Group
		1-16	OA-4917/TST-2 (Container
		1-16	TF1)
		1-16	1-25
		1-16	Radio Transmitting Set AN/
		1-16	TRT-20 (Container TH2).
		1-16	1-25

SECTION I—DESCRIPTION AND LEADING PARTICULARS (CONT)

SECTION I—DESCRIPTION AND LEADING PARTICULARS (CONT)

Paragraph		Page
1-59	Radio Transmitting Set AN/TRT-24 (Container TH3)	1-28
1-60	Radio Transmitting Set AN/TRT-25 (Containers TH4 and TG4)	1-28
1-62	Antenna Coupler Group OA-4940/TST-2 (Helix Container) .	1-28
1-63	Power Distribution Group OA-4921/TSQ-55 (Container GT1) .	1-28
1-64	Power Control Group OA-4922/TSQ-55 (Container GT2)	1-28
1-65	Generator Set, Diesel Engine PU-600/TSQ (Containers GT3, GT4, GT5 and GT6)	1-28
1-66	Mobile Workshop Trailer	1-28
1-67	Typical Construction AN/TSC-35 Containers	1-32
1-68	Container Exterior	1-32
1-69	Floor, Walls and Roof	1-32
1-70	Lifting, Locking and Aligning Pins	1-32
1-71	Tie-Down Rings	1-34
1-72	Roof Walkways	1-34
1-73	Sidewall Reinforcement	1-34
1-74	Wall Cutouts	1-34
1-75	Container Interior	1-35
1-76	Tapping Plates	1-35
1-77	Power Containers	1-35
1-78	Floor, Walls, and Ceiling	1-35
1-79	Air Intake Cutouts	1-36
1-81	Equipment Mounting and Installation	1-36
1-83	Standard Rack Base	1-38
1-84	Standard Equipment Rack	1-38
1-85	Rack and Equipment Identification System	1-38
1-87	Signal Ducts	1-39
1-89	Duct Size	1-39
1-90	Cross Container Duct	1-45
1-91	Typical Duct Installation	1-45
1-92	Container Support Assemblies	1-45
1-94	Container Lifting Sling	1-46
1-95	Air Conditioners	1-46
1-97	Electronic Clock System Equipment	1-53
1-98	Voice Intercom Equipment	1-53
1-99	Station Internal TTY Order-Wire System	1-53
1-100	Microwave Equipment	1-53
1-101	Antennas and Transmission Lines	1-53
1-103	Primary Electric Power Plants	1-53
1-104	Receiving Central Electric Power Plant AN/TSQ-56	1-53
1-106	Transmitting Central Electric Power Plant AN/TSQ-55	1-55
1-107	Power Plant Typical Operation	1-55
1-110	Power Cable Installation	1-56
1-111	General	1-56
1-112	Material and Equipment Provided	1-56
1-113	Installation Procedures	1-63
1-114	Power System Manuals	1-63

Paragraph		Page
1-115	AN/TSC-35 Electronic Equipment .	1-63
1-116	Tools and Maintenance Material	1-63
1-117	Supplied	1-63
1-117	Portable Tool Kits	1-63
1-118	Electronic Work Bench Kits	1-63
1-119	Antenna Field Tool Kits	1-63
1-120	Heavy Duty Work Bench Kits	1-64
1-121	Miscellaneous Maintenance Material	1-64

SECTION II—AN/TSC-35 SIGNAL DISTRIBUTION

2-1	Introduction	2-1
2-2	General	2-1
2-3	Signal Distribution Frames	2-1
2-5	Typical Program Board Construction	2-1
2-6	Coaxicon Connector Block and Connectors	2-1
2-9	Program Patchcords	2-1
2-10	Signal Grounding	2-1
2-12	Program Board and Connector Designations	2-3
2-14	Typical Monitor Patchfield Construction	2-3
2-17	RED Main Distribution Frame	2-4
2-18	RED MDF Program Board	2-4
2-20	RED MDF Monitor Patchbay	2-4
2-23	BLACK Main Distribution Frame	2-4
2-25	BLACK MDF Program Board	2-4
2-27	BLACK MDF Monitor Patchbay	2-4
2-29	Receivers Intermediate Distribution Frame	2-9
2-31	Transmitters Audio Main Distribution Frame	2-9
2-32	Audio MDF Modification	2-9
2-33	Audio Signal Circuits	2-9
2-34	Transmitters DC Main Distribution Frame	2-9
2-35	Transmitters DC Program Board	2-9
2-36	Transmitters DC Monitor Patchbay	2-9
2-38	Special Distribution Frames	2-9
2-39	Special Distribution Frame, RE2	2-9
2-40	RE2 SDF Program Board	2-11
2-41	RE2 SDF Monitor Patchfield	2-11
2-42	RED Special Distribution Frame, RA3	2-12
2-43	RA3 SDF Red Program Board	2-12
2-44	RA3 SDF Red Monitor Patchfield	2-12
2-45	BLACK Special Distribution Frame, RA3	2-12
2-46	Tone Converter Modulators and Demodulators	2-12
2-47	Trip Control Modulators and Demodulators	2-12

**SECTION II—AN/TSC-35 SIGNAL
DISTRIBUTION (CONT)**

Paragraph		Page
2-48	Telegraph Terminal Equipment . .	2-12
2-49	Receiving Central Telegraph Terminals	2-12
2-50	AN/FGC-60/24 System . . .	2-12
2-51	AN/FGC-60/22 System . . .	2-12
2-52	AN/FGC-60/19 System . . .	2-12
2-53	AN/FGC-60/23A System . . .	2-12
2-54	Transmitting Central Tele- graph Terminals	2-14
2-55	AN/FGC-60/29 System . . .	2-14
2-56	AN/FGC-60/23B System . . .	2-14
2-57	TH-39A/UGT Tone Intelligence Unit	2-14
2-58	TD-410/UGS Multiplexer and TD- 411/UGC Demultiplexer	2-14

**SECTION II—AN/TSC-35 SIGNAL
DISTRIBUTION (CONT)**

Paragraph		Page
2-61	Signal Junction Box	2-14
2-63	Typical Signal Distribution, Receiving Central	2-14
2-64	Typical Signal Distribution, Transmitting Central	2-14
2-66	Signal Cables	2-17
2-67	Signal Cable Identification System	2-17
2-68	Inter-Container Cables . . .	2-17
2-69	Intra-Container Cables . . .	2-17
2-70	Intra-Rack Signal Pairs. . .	2-17
2-71	Signal Cable Records	2-17
2-72	Cable Pair Record Card . . .	2-17

**VOLUME II
RECEIVING CENTRAL AN/TSR-1**

TABLE OF CONTENTS

SECTION I—DESCRIPTION OF AN/TSR-1 CONTAINERS		SECTION I—DESCRIPTION OF AN/TSR-1 CONTAINERS (CONT)	
Paragraph	Page	Paragraph	Page
1-1	Introduction	1-1	Signal Duct Installation
1-2	General	1-1	RED Signal Duct
1-3	Rack Base Duct	1-1	BLACK Signal Duct
1-4	Rack and Equipment Mounting	1-57	Power Distribution
1-6	Rack Wiring	1-59	Teletype Central AN/TGC-16 (Container RB1)
1-9	Container Wiring	1-61	Main Distribution Frame, Red
1-10	Detailed Description of AN/TSR-1 Containers	1-62	RED Program Board
1-11	Receiving Central Group OA-3887/TSR-1 (Container RA1)	1-63	RED Audio Patchfield
1-12	Left Side Equipment	1-67	KW-37 Facility Installation
1-14	Right Side Equipment	1-68	KW-37 Mounting Frame
1-16	Typical Operation, Torn-Tape Relay	1-70	KW-37 Tone Converter Rack
1-18	Signal Duct and Cable Installation	1-73	Teletype Equipment
1-19	RED Signal and Cabling	1-75	TTY Test Equipment
1-22	Power Distribution	1-77	Signal Duct and Cable Installation
1-23	Receiving Central Group OA-4936/TSR-1 (Container RA2)	1-79	Power Distribution
1-24	Off-Line Area	1-80	Receiving Central Group OA-4937/TSR-1 (Container RB2)
1-26	Repair Area	1-81	Right-Side Equipment
1-27	Test Equipment Supplied, OA-4936/TSR-1 (Container RA2)	1-82	Left Side Equipment
1-28	Signal Duct and Cable Installation	1-83	Typical KW-26 Rack
1-29	RED Signal Duct	1-84	Equipment Mounting
1-30	BLACK Signal Duct	1-85	Rack Construction
1-31	Power Distribution	1-87	KW-26 Tone Converter Drawer
1-33	Receiving Central Group OA-7041/TSR-1, Container RA3	1-89	KW-26 Order Wire Rack Assembly
1-34	Special Construction Features	1-90	KW-26 Order-Wire Control Panel
1-35	Equipment Installation	1-91	KW-7 Rack
1-36	Right Side Equipment	1-92	RB2 Signal Duct and Cable Installation
1-37	Left Side Equipment	1-94	KW-26 Signal and Indicator Cabling
1-38	KW-26 Equipment	1-95	KW-26 Order Wire Cabling
1-39	RED Control Rack	1-97	Power Distribution, RB2
1-41	Special Distribution Frame	1-98	Receiving Central Group OA-4938/TSR-1 (Container RB3)
1-42	DC Patchfield	1-99	Right-Side Equipment
1-43	Audio Patchfield	1-100	Left Side Equipment
1-45	Tone Converter Drawer	1-101	KW-26 Equipment Racks
1-46	Loop Supply Drawers	1-103	Modified KW-26 Tone Converter Drawer
1-47	Meter Unit	1-105	KW-26 Order-Wire Racks
1-48	RED Intercom Unit	1-106	TB3 Signal Duct and Cable Installation
1-49	BLACK Control Rack		
1-50	Teletype Equipment		
1-51	RF Distribution		
1-52	Test Equipment Supplied, OA-7041/TSR-1 (Container RA3)		

**SECTION I—DESCRIPTION OF AN/TSR-1
CONTAINERS (CONT)**

Paragraph		Page
1-107	KW-26 Order Wire Cabling	1-28
1-108	Power Distribution	1-28
1-109	Receiving Central Group OA-4939/TSR-1 (Container RC1)	1-28
1-111	Equipment Installation	1-28
1-113	AN/UGC-1A Rack Assembly	1-28
1-115	AN/UGC-1A Equipment	1-28
1-117	AN/UGC-1A RED Tone Converter Drawer	1-28
1-120	AN/UGC-1A RED Loop Supply Drawer	1-35
1-121	AN/UGC-1A BLACK Tone Converter Drawer	1-35
1-122	Signal Duct and Cable Installation	1-35
1-125	Power Distribution	1-35
1-126	Maintenance Equipment Group OA-4941/TSR-1 (Container RD1)	1-35
1-127	Left Side Equipment	1-35
1-128	Right Side Equipment	1-35
1-129	Test Equipment Supplied	1-35
1-130	Signal Duct and Cable Installation	1-35
1-131	Power Distribution	1-36
1-132	Supply Center OA-4942/TSR-1 (Container RD2)	1-36
1-133	Equipment Installation	1-36
1-134	Power Distribution	1-36
1-135	Teletype Central AN/TGC-17 (Container RE1)	1-36
1-136	Left Side Equipment	1-41
1-137	Right Side Equipment	1-41
1-138	Main Distribution Frame, BLACK	1-41
1-140	BLACK Program Board	1-41
1-141	BLACK TTY and Audio Patchfields	1-41
1-144	TTY Equipment Racks	1-41
1-145	Test Equipment Rack RE-1.15	1-41
1-147	Test Equipment Rack RE-1.19	1-42
1-149	Signal Duct and Cable Installation	1-42
1-151	Tone-Telegraph Terminal Equipment Wiring	1-42
1-152	Power Distribution	1-42
1-153	Receiving Central Group OA-4943/TSR-1, (Container RE2)	1-42
1-154	Voice Operating Position RE2.23	1-42
1-156	Voice Equipment Rack RE2.21	1-49
1-157	Voice Equipment Rack RE2.25	1-49
1-159	Microwave Equipment	1-49
1-161	VHF Equipment Rack RE2.27	1-49
1-162	UHF Equipment Racks RE2.29, RE2.31	1-49

**SECTION I—DESCRIPTION OF AN/TSR-1
CONTAINERS (CONT)**

Paragraph		Page
1-163	Signal Duct and Cable Installation	1-49
1-165	Power Distribution	1-49
1-166	Receiving Central Group OA-4944/TSR-1 (Container RE3)	1-49
1-169	Right Side Equipment	1-50
1-170	AN/FRR-60 Installation	1-50
1-172	TTY, Rack RE3.12	1-50
1-174	RLPA, Control Rack, RE3.2	1-50
1-175	Left Side Equipment	1-50
1-176	Receivers IDF	1-50
1-179	TD-411/UGC Demultiplexer Rack RE3.11	1-55
1-180	VLFC Rack RE3.13	1-55
1-181	High-Frequency FSK Racks.	1-55
1-186	Low-Frequency FSK Rack RE3.31	1-55
1-188	FSK Converter Rack RE3.33	1-56
1-190	Monitor Receiver Rack RE3.35	1-56
1-193	Monitor Receiver Racks RE3.37 and RE3.39	1-56
1-194	Signal Duct and Cable Installation	1-56
1-196	Power Distribution	1-56
1-197	Receiving Central Group AN/TSR-2 (Container RE4)	1-57
1-199	Left Side Equipment	1-57
1-200	Right Side Equipment	1-57
1-201	AN/FRR-60 Installation	1-57
1-203	SPP-40416 RF Switching Patch Panel	1-57
1-204	CU-656/U RF Multicoupler	1-57
1-205	LFD-1 Low-Frequency Antenna Distribution Unit.	1-57
1-206	Antenna Entry Box.	1-57
1-207	Receivers RF Distribution Facility	1-57
1-208	RF Patchfield	1-57
1-209	CU-656/U Multicoupler Racks	1-58
1-210	RF Distribution Facility Cabling.	1-58
1-213	Facsimile Installation	1-58
1-215	Facsimile Equipment Rack RE4.27	1-58
1-216	Signal Duct and Cable Installation	1-58
1-217	Power Distribution, RE4	1-63
1-219	Receiving Central Group OA-4945/TSR-1 (Container RF1)	1-63
1-220	Right Side Equipment	1-63
1-221	Left Side Equipment	1-63
1-223	Teletype Equipment	1-63
1-224	TT-176A Equipment Racks	1-63

**SECTION I—DESCRIPTION OF AN/TSR-1
CONTAINERS (CONT)****SECTION I—DESCRIPTION OF AN/TSR-1
CONTAINERS (CONT)**

Paragraph		Page	Paragraph		Page
1-225	AN/FGC-59 Equipment . . .	1-63	1-292	Sonic Cleaner System . . .	1-80
1-227	AN/UGC-5 Equipment . . .	1-64	1-293	Test and Maintenance Equipment Supplied	1-80
1-228	TT-47 Internal Order Wire Equipment	1-64	1-294	Signal Duct and Cable Installation	1-80
1-229	Signal Duct and Cable Installation, RF1	1-64	1-295	Power Distribution	1-80
1-230	RED Signal Duct.	1-64	1-297	Teletype Central AN/TGC-18 (Container RJ1)	1-80
1-232	Power Distribution, RF1 . . .	1-64	1-301	Left Side Equipment	1-83
1-235	Control Monitor Group OA- 4950/TSR-1 (Container RF2) . .	1-69	1-303	Right Side Equipment	1-83
1-238	Left Side Equipment	1-69	1-304	TT-331 Tone Converter Panel	1-83
1-239	Right Side Equipment	1-69	1-305	TT-176A Tone Converter. . .	1-83
1-240	CW Operating Positions. . . .	1-69	1-307	Signal Duct and Cable Installation	1-83
1-231	Receiver Control Panels, RF2	1-69	1-308	RED Signal Duct, RJ1	1-83
1-242	Transmitter Control Panel, RF2	1-69	1-309	Audio Signal Duct, RJ1 . . .	1-83
1-244	Morse Code Converter Rack RF2, 17	1-70	1-310	DC Signal Duct, RJ1	1-84
1-245	660A Tone Converter Drawer	1-70	1-311	Audio Signal Wiring, NTX Receive.	1-84
1-246	TT-176A Tone Converter Drawer.	1-70	1-313	Power Distribution, RJ1 . . .	1-84
1-247	Teletype Equipment	1-70	1-315	Teletype Central AN/TGC-19 (Container RJ2)	1-84
1-248	AN/UGC-8 Tone Converter Panels	1-70	1-317	Equipment Installation, RJ2 .	1-84
1-249	TT-47 Tone Converter Panels	1-70	1-320	AN/FGC-59 Equipment. . . .	1-84
1-250	AN/UGC-6 Pony Tone Converter Panel.	1-70	1-323	AN/FGC-73 Equipment. . . .	1-91
1-251	Signal Duct and Cable Installation	1-70	1-324	NTX Torn Tape Relay, Typical Operation	1-91
1-252	BLACK Signal Duct	1-70	1-327	Signal Duct and Cable Installation RJ2	1-91
1-254	Power Distribution, RF2 . . .	1-70	1-328	Audio Signal Duct, RJ2 . . .	1-91
1-257	Control Monitor Group OA-4951/ TSR-1 (Container RF3)	1-73	1-329	DC Signal Duct, RJ2	1-91
1-260	Air-Ground Operating Positions	1-73	1-330	Power Distribution, RJ2 . . .	1-91
1-264	Receiver Control Panel RF3	1-73	1-332	Power Distribution Group OA- 4968/TSQ-56 (Container GR1) .	1-91
1-267	Transmitter Control Panel, RF3	1-73	1-333	Power Control Group OA-4969/ TSQ-56 (Container RG-2) . . .	1-91
1-269	Signal Duct and Cable Installation	1-74	1-334	Diesel Engine Generator Set PU-600/TSQ (Containers GR3 and GR6)	1-91
1-270	Power Distribution, RF3 . . .	1-74	1-335	Diesel Engine Generator Set PU-612/TSQ (Containers GR4 and GR5)	1-91
1-273	Receiving Central Group OA- 4966/TSR-1 (Container RG1) . .	1-74	SECTION II—INSTALLATION		
1-276	Signal Duct and Cable Installation	1-74	2-1	Introduction	2-1
1-277	Power Distribution.	1-74	2-2	Receiving Central AN/TSR-1 Antennas.	2-1
1-279	Maintenance Equipment Group OA-4967/TSR-1 (Container RH1)	1-74	2-4	Coaxial Cables	2-1
1-281	Left Side Equipment	1-79	2-6	Receiving Central Ground System	2-1
1-282	Right Side Equipment	1-79	2-7	Signal Ground	2-1
1-285	Test Benches	1-79	2-9	Rack and Equipment Grounding	2-2
1-288	Printer Test Bench	1-79	2-12	Receiving Central Earth Ground Grid.	2-2
1-289	Reperforator Test Bench. . .	1-79	2-13	Primary AC Power System, Receiving Central.	2-2
1-290	Transmitter Distributor Test Bench	1-79	2-14	Primary Power Cabling, Generators to GR1	2-2
1-291	Repair Bench	1-79	2-16	Standard Power	2-2

**SECTION II—INSTALLATION
(CONT)**

Paragraph		Page
2-17	No-Break Power	2-2
2-20	Primary AC Power Distribution, GR1 to Equipment Containers	2-6
2-24	Power Line Interference Filters	2-7
2-25	Power Distribution Receiving Central Containers	2-7
2-26	Power Distribution Tables	2-7

SECTION III—SYSTEM OPERATION

3-1	Introduction	3-1
3-4	Operational Concept	3-1
3-5	Tone Conversion System	3-1
3-10	Tone Converters and Loop Supplies	3-1
3-11	Model 6002-1 Modulator	3-1
3-12	Model 6002-2 Demodulator	3-2
3-14	Model 6004-1 Trip-Control Modulator	3-2
3-15	Model 6004-2 Trip-Control Demodulator	3-2
3-16	Model 6006 Loop Supply	3-2
3-17	Tone Converter Operation	3-2
3-18	Phase-Shift Tone Converters	3-2
3-20	Demodulator Phase Detection Characteristics	3-2
3-24	Frequency Shift Tone Converters	3-3
3-28	Typical Circuits	3-3
3-32	Program Patching, Audio Signal	3-4
3-33	Program Patching, DC Signal	3-4
3-36	Typical Point-to-Point Receive Circuit	3-5
3-40	TTY Signal Path	3-6
3-45	Voice Signal Path	3-6
3-46	Typical Point-to-Point Send Circuit	3-6
3-56	Typical 4-Channel Multiplex Send Circuit	3-12
3-68	Typical 4-Channel Multiplex Receive Circuit	3-15
3-80	Typical CW Send/Receive Circuit	3-16
3-91	Typical Search and Rescue Send/Receive Circuit	3-21
3-101	Typical Facsimile Send/Receive Circuit	3-22
3-107	Typical Circuit Programming, Container RA3	3-27
3-109	Typical Local KW-26 Circuit Programming RA3	3-27
3-115	Typical Remote KW-26 Circuit Programming RA3	3-27
3-119	Voice and CW Operating Positions	3-28

**SECTION III—SYSTEM OPERATION
(CONT)**

Paragraph		Page
3-120	Point-To-Point Voice Operating Positions, RE2	3-28
3-122	Receiver Control and Programming, RE2	3-28
3-126	Transmitter Control and Programming, RE2	3-34
3-131	CW Operating Positions Container RF2	3-34
3-132	Receiver Control Panel RF2	3-34
3-136	Transmitter Control Panel RF2	3-40
3-139	Air/Ground Operating Positions, RF3	3-40
3-140	Receiver Control Panel RF3	3-40
3-143	Transmitter Control Panels RF3	3-45
3-147	Station TTY Internal Order-Wire System	3-45
3-148	Internal Order-Wire Circuit	3-45
3-150	Internal Order-Wire Circuit, RA3	3-45
3-152	Internal Order-Wire Programming	3-46
3-154	Transmitting Central Internal Order-Wire Circuit	3-46
3-160	Code Format Converter Systems	3-46
3-162	Code Format Converter Equipment	3-51
3-163	AN/UGC-6 Teletype Equipment	3-51
3-164	660A Teleprinter to Morse Code Converter	3-51
3-165	660A Tone Converter Drawer	3-51
3-166	BSP-2 Speaker-Amplifier	3-51
3-167	Code Format Converter Operation	3-51
3-168	CW Operation	3-51
3-170	RATT Operation	3-51
3-171	KW-26 Order-Wire Control Panels	3-52
3-178	Point-To-Point Order Wire Control Circuit	3-52

**SECTION IV—TECHNICAL DESCRIPTION
OF SPECIAL CIRCUITS**

4-1	Introduction	4-1
4-2	AN/FGC-59 Tone Converters	4-1
4-3	TT-331 Tone Converter Panel	4-1
4-6	TT-333 Tone Converter and Loop Supply-Relay Panels	4-1
4-11	KW-26 Tone Converter Drawers	4-2
4-12	Right-Hand Tone Converter Drawer	4-2
4-19	Left-Hand Tone Converter Drawer	4-6
4-21	Modified KW-26 Tone Converter Drawer	4-6
4-24	KW-26 Order-Wire Control Panel	4-6
4-31	AN/FGC-60(V) Telegraph Terminal Tone Converters	4-15

**SECTION IV—TECHNICAL DESCRIPTION
OF SPECIAL CIRCUITS (CONT)**

**SECTION IV—TECHNICAL DESCRIPTION
OF SPECIAL CIRCUITS (CONT)**

Paragraph	Page
4-33 AN/FGC-60/19 Demodulator Tone Converter Drawer	4-15
4-37 AN/FGC-60/19 Modulator Tone Converter Drawer	4-16
4-41 AN/FGC-60/22 Demodulator Tone Converter Drawer	4-16
4-45 AN/FGC-60/22 Modulator Tone Converter Drawer	4-16
4-49 AN/FGC-60/23A Demodulator Tone Converter Drawer	4-16
4-53 AN/FGC-60/24 Tone Con- verter Drawer	4-19
4-58 AN/UGC-1A Tone Converters . . .	4-20
4-59 AN/UGC-1A BLACK Tone Converter Drawer	4-20
4-63 AN/UGC-1A RED Tone Converter Drawer	4-29
4-80 KW-37 Tone Converters	4-32
4-81 KW-37 BLACK Tone Converter Drawer	4-32
4-87 KW-37 RED Tone Converter Drawer	4-36
4-93 KW-37 Order-Wire Equipment Rack	4-36
4-95 Point-to-Point Order-Wire Tone Converter Panel	4-36
4-102 Internal Order-Wire Tone Converter Panel	4-39
4-106 TTY Monitor Tone Converter Panel	4-40

Paragraph	Page
4-110 AN/UGC-5, AN/UGC-6 Tone Converter Panel	4-40
4-112 AN/UGC-8, TT-47, TT-171 Tone Converter Panel	4-40
4-114 2067 System Tone Converter Drawer	4-40
4-119 FSK Tone Converter Panels . . .	4-44
4-121 FSK Tone Converter Panel, Dry Key.	4-47
4-124 FSK Tone Converter Panel, Wet Key.	4-47
4-128 AN/GGM-1 Tone Converter Panel	4-48
4-132 Container RA3 Tone Converters .	4-49
4-133 RED Tone Converter Drawer, RA3.16	4-49
4-136 BLACK Tone Converter Drawer, RA3.15	4-50
4-139 Loop Supply Drawers, RA3 . .	4-50
4-143 660A Tone Converter Drawer . .	4-50
4-147 HW-19 Tone Converter Drawer .	4-50
4-152 Voice Operating Position, RE2 . .	4-55
4-153 Operating Positions RF2, RF3 . .	4-55
4-154 Facsimile Position Wiring	4-55
4-155 Test Bench Wiring, RH1.	4-60
4-156 Equipment Rack Wiring RE2 . . .	4-60
4-157 Antenna Patch and Multicoupler Rack RA3.19	4-60
4-158 TD-411/UGC Demultiplexer Rack RA3.11	4-60
4-159 AN/FCC-17 Cabling.	4-60

VOLUME III
TRANSMITTING CENTRAL AN/TST-2
TABLE OF CONTENTS

SECTION I—DESCRIPTION OF CONTAINERS		SECTION I—DESCRIPTION OF CONTAINERS (CONT)	
Paragraph	Page	Paragraph	Page
1-1	Introduction	1-1	1-107 Power Distribution Group
1-6	Control-Monitor Group OA-4915/ TST-2	1-2	OA-4922/TSQ-55 1-39
1-14	Radio Transmitting Set AN/ TRT-17	1-2	1-108 Diesel Engine Generator Set PU-600/TSQ 1-39
1-16	Model AN/FRT-39D Transmitter	1-2	
1-26	Ventilation Ducts	1-12	
1-30	Signal Duct and Cable Installation.	1-12	
1-33	Power Cabling	1-12	
1-35	Radio Transmitting Set AN/TRT-18.	1-12	
1-37	Model AN/FRT-40B Transmitter	1-17	
1-43	Ventilation Ducts	1-18	
1-46	Signal Duct and Cable Installation.	1-18	
1-49	AN/TRT-18 Power Cabling	1-18	
1-51	Radio Transmitting Set AN/TRT-20.	1-18	
1-52	Radio Transmitting Set AN/TRT-23.	1-18	
1-54	Model AN/URT-19 (V) Transmitter	1-23	
1-64	AN/TRT-23 Signal Duct and Cable Installation.	1-24	
1-65	AN/TRT-23 Power Cabling	1-24	
1-66	Radio Transmitting Set AN/TRT-24.	1-25	
1-78	Radio Transmitting Set AN/TRT-25.	1-26	
1-87	Radio Transmitting Set AN/TRT-19.	1-33	
1-92	Antenna Coupler Group OA- 4940/TST-2.	1-33	
1-96	Interconnect Group OA-4916/ TST-2	1-34	
1-101	Interconnect Group OA-4918/ TST-2	1-34	
1-102	Maintenance Equipment Group OA-4917/TST-2.	1-34	
1-105	Test Equipment Supplied, OA- 4917/TST-2, Container TF1	1-39	
1-106	Power Distribution Group OA- 4921/TSQ-55	1-39	
			SECTION II—INSTALLATION
		2-1	Introduction 2-1
		2-2	Antenna Field, Transmitting Central AN/TST-2 2-1
		2-3	RF Distribution System, Trans- mitting Central. 2-1
		2-4	Balanced Open-Wire Trans- mission Lines 2-1
		2-5	Coaxial Cables. 2-1
		2-6	RF Patching, Transmitters 2-1
		2-7	Coaxial Patch Panel 2-2
		2-9	Ground System Installation, Transmitting Central 2-2
		2-11	Signal Grounding. 2-2
		2-12	Earth Ground System. 2-2
		2-13	Primary Power Distribution, Transmitting Central 2-2
		2-17	Power Distribution Tables .2-27/2-28
			SECTION III—DESCRIPTION OF SPECIAL CIRCUITS AND MODIFICATIONS
		3-1	Introduction 3-1
		3-2	General 3-1
		3-4	Transmitter Input and Control Circuits 3-1
		3-7	Radiation Indicator and Trans- mitter Alarm Circuits. 3-1
		3-11	Transmitter RF Monitor Circuits. 3-5
		3-12	Transmitter Extended Interlock Circuits 3-5
		3-14	AN/URT-19(V) Transmitter Rack Wiring 3-5
		3-21	AN/FRT-62 Driver Switching 3-6
		3-24	TD-410/UGC Multiplexer Rack. 3-6
		3-25	Typical Circuits 3-6

VOLUME I
U. S. NAVY TRANSPORTABLE COMMUNICATION SYSTEM AN/TSC-35

LIST OF ILLUSTRATIONS

SECTION I—DESCRIPTION AND LEADING PARTICULARS			SECTION I—DESCRIPTION AND LEADING PARTICULARS (CONT)		
Figure	Title	Page	Figure	Title	Page
1-1	Receiving Central, AN/TSR-1, Artist's Concept.	xxiii	1-26	Receiving Central Group OA-4945/TSR-1 (RF1, Left Side Equipment).	1-23
1-2	Transmitting Central, AN/TST-2, Artist's Concept	xxiv			
1-3	Site Plan, Receiving Central AN/TSR-1 Containers	1-3	1-27	Receiving Central Group OA-4945/TSR-1 (RF1, Right Side Equipment).	1-24
1-4	Site Plan, Transmitting Central AN/TST-2 Containers	1-4	1-28	Control Monitor Group OA-4950/TSR-1 (RF2, Left Side Equipment).	1-24
1-5	Receiving Central Group OA-3887/TSR-1 (RA1 Right Side Equipment).	1-7	1-29	Control Monitor Group OA-4950/TSR-1 (RF2, Right Side Equipment).	1-25
1-6	Receiving Central Group OA-3887/TSR-1 (RA1 Left Side Equipment)	1-8	1-30	Control Monitor Group OA-4951/TSR-1 (RF3, Operations Area)	1-26
1-7	Receiving Central Group OA-4936/TSR-1 (RA2, Off-Line Area)	1-8	1-31	Receiving Central Group OA-4966/TSR-1 (RG1, Equipment Installation) ,	1-27
1-8	Receiving Central Group OA-4936/TSR-1 (RA2, Crypto Repair Area).	1-9	1-32	Maintenance Equipment Group OA-4967/TSR-1 (RH1, Right Side Equipment)	1-28
1-9	Receiving Central Group OA-7041/TSR-1 (RA3, Rear Area)	1-10	1-33	Maintenance Equipment Group OA-4967/TSR-1, (RH1, Left Side Equipment).	1-29
1-10	Receiving Central Group OA-7041/TSR-1 (RA3, Front Area)	1-11	1-34	Teletype Central AN/TGC-18 (RJ1, Right Side Equipment)	1-30
1-11	Teletype Central AN/TGC-16 (RB1, Equipment Installation).	1-12	1-35	Teletype Central AN/TGC-18 (RJ1, Left Side Equipment).	1-31
1-12	Receiving Central Group OA-4937/TSR-1 (RB2, Right Side Equipment)	1-13	1-36	Teletype Central AN/TGC-19 (RJ2, Equipment Installation)	1-32
1-13	Receiving Central Group OA-4937/TSR-1 (RB2, Left Side Equipment).	1-13	1-37	Radio Transmitting Set AN/TRT-17, 10-K (TA1, TA2 and TG2)	1-33
1-14	Receiving Central Group OA-4938/TSR-1 (RB3, Right Side Equipment)	1-14	1-38	Radio Transmitting Set AN/TRT-17, 10-K (TB2, TB3, TC4 and TD4)	1-34
1-15	Receiving Central Group OA-4938/TSR-1 (RB3, Left Side Equipment).	1-14	1-39	Radio Transmitting Set AN/TRT-23, 1K and 10K (TA3, Front Area)	1-35
1-16	Receiving Central Group OA-4939/TSR-1 (RC1, Equipment Installation).	1-15	1-40	Radio Transmitting Set AN/TRT-23, 1K and 10K (TA3, Rear Area).	1-36
1-17	Maintenance Equipment Group OA-4941/TSR-1 (RD1, Equipment Installation).	1-15	1-41	Radio Transmitting Set AN/TRT-18, 40-K (TB1 and TH1).	1-37
1-18	Supply Center OA-4942/TSR-1 (RD2, Rear Area)	1-16	1-42	Radio Transmitting Set AN/TRT-18, 40-K (TC2, TC3, TD2, TD3 and TG3).	1-38
1-19	Teletype Central AN/TGC-17 (RE1, Left Side Equipment).	1-17	1-43	Control Monitor Group OA-4915/TST-2 (TC1, Equipment Installation)	1-39
1-20	Teletype Central AN/TGC-17 (RE1, Right Side Equipment)	1-17	1-44	Interconnect Group OA-4916/TST-2 (TD1, Equipment Installation)	1-40
1-21	Receiving Central Group OA-4943/TSR-1 (RE2, Equipment Installation).	1-18	1-45	Interconnect Group OA-4918/TST-2 (TG1, Equipment Installation)	1-41
1-22	Receiving Central Group OA-4944/TSR-1 (RE3, Left Side Equipment).	1-19			
1-23	Receiving Central Group OA-4944/TSR-1 (RE3, Right Side Equipment)	1-20			
1-24	Receiving Central Group AN/TSR-2 (RE4, Front Area)	1-21			
1-25	Receiving Central Group AN/TSR-2 (RE4, Rear Area)	1-22			

SECTION I—DESCRIPTION AND LEADING PARTICULARS (CONT)

Figure	Title	Page
1-46	Radio Transmitting Set AN/TRT-19, Low Frequency (TE1, Equipment Installation)	1-42
1-47	Maintenance Equipment Group OA-4917/TST-2 (TF1, Shop Area)	1-43
1-48	Radio Transmitting Set AN/TRT-20 (40K Installation)	1-44
1-49	Radio Transmitting Set AN/TRT-24 (TH3, 200-K Installation)	1-45
1-50	Radio Transmitting Set AN/TRT-24 (TH3, Front Area)	1-46
1-51	Radio Transmitting Set AN/TRT-25 (TH4, 50-K Installation, Rear Area)	1-47
1-52	Radio Transmitting Set AN/TRT-25 (TH4, 50-K Installation, Front Area)	1-47
1-53	Radio Transmitting Set AN/TRT-25 (TG-4, Low-Pass Filter)	1-48
1-54	Radio Transmitting Set AN/TRT-25 (TG-4, Low-Pass Filter)	1-48
1-55	Antenna Coupler Group OA-4940/TST-2 (Helix, Vestibule Area)	1-49
1-56	Antenna Coupler Group OA-4940/TST-2 (Helix, Equipment Installation)	1-50
1-57	Typical AN/TSC-35 Container Construction (Top Sectional View)	1-51/1-52

SECTION I—DESCRIPTION AND LEADING PARTICULARS (CONT)

Figure	Title	Page
1-58	Container Support Assembly	1-56
1-59	Container Lifting Sling	1-57/1-58
1-60	Clock System Equipment Location, Cable, and Wiring List	1-59/1-60
1-61	Mobile Workshop Trailer, Isometric View	1-61/1-62

SECTION II—AN/TSC-35 SIGNAL DISTRIBUTION

2-1	BLACK MDF Installation, Container RE1	2-2
2-2	Twin-Coaxicon Signal Block Female, Typical	2-3
2-3	Wiring Standard, MDF Block Cable Termination	2-5/2-6
2-4	RED MDF Installation, Container RB1	2-7
2-5	RED Audio Patchfield, One Position, Typical Jack Wiring	2-8
2-6	BLACK Audio Patchfield, One Position, Typical Jack Wiring	2-10
2-7	DC Patchfield, One Position, Typical Jack Wiring	2-11
2-8	RED SDF, Construction Details	2-13
2-9	Signal Cable Numbering, Typical	2-15/2-16
2-10	Cable Pair Record Card, Typical Example	2-18

VOLUME II RECEIVING CENTRAL AN/TSR-1

LIST OF ILLUSTRATIONS

SECTION I—DESCRIPTION OF AN/TSR-1 CONTAINERS			SECTION I—DESCRIPTION OF AN/TSR-1 CONTAINERS (CONT)		
Figure	Title	Page	Figure	Title	Page
1-1	Site Plan, Receiving Central AN/TSR-1 Containers	1-2	1-19	Receiving Central Group OA-4944/TSR-1 (Container RE3, Receivers, Left Side)1-53/1-54
1-2	Receiving Central Group OA-3887/TSR-1 (Container RA1-HICOM/ASC Left Side)	1-3/1-4	1-20	Receiving Central AN/TSR-2 (Container RE4, Receivers, Left Side)1-59/1-60
1-3	Receiving Central Group OA-3887/TSR-1 (Container RA1-HICOM/ASC Right Side)	1-5/1-6	1-21	Receiving Central AN/TSR-2 (Container RE4, Receivers, Right Side)1-61/1-62
1-4	Receiving Central Group OA-4936/TSR-1 (Container RA2, Off-Line and Crypto Repair)1-9/1-10	1-22	Receiving Central Group, OA-4945/TSR-1 (Container RF1-Message Center, Right Side)1-65/1-66
1-5	Receiving Central Group OA-7041/TSR-1 (Container RA3 Right Side)	1-13/1-14	1-23	Receiving Central Group OA-4945/TSR-1 (Container RF1-Message Center, Left Side)1-67/1-68
1-6	Receiving Central Group OA-7041/TSR-1 (Container RA3 Left Side)	1-15/1-16	1-24	Control Monitor Group OA-4950/TSR-1 (Container RF2, CW, Ship/Shore)1-71/1-72
1-7	Teletype Central AN/TGC-16 (Container RB1 Classified Control)	1-19/1-20	1-25	Control-Monitor Group OA-4951/TSR-1 (Container RF3, Air-Ground)1-75/1-76
1-8	Receiving Central Group OA-4937/TSR-1 (Container RB2 - Crypto, Right Side)	1-23/1-24	1-26	Receiving Central Group OA-4966/TSR-1 (Container RG1-Communication Office)1-77/1-78
1-9	Receiving Central Group OA-4937/TSR-1 (Container RB2 - Crypto, Left Side)	1-25/1-26	1-27	Maintenance Equipment Group OA-4967/TSR-1 (Container RH1-TTY Repair)1-81/1-82
1-10	Receiving Central Group OA-4938/TSR-1 (Container RB3 - Crypto, Right Side)	1-29/1-30	1-28	Teletype Central AN/TGC-18 (Container RJ1-NTX Receive, Right Side)1-85/1-86
1-11	Receiving Central Group OA-4938/TSR-1 (Container RB3 - Crypto, Left Side)	1-31/1-32	1-29	Teletype Central AN/TGC-18 (Container RJ1-NTX Receive, Left Side)1-87/1-88
1-12	Receiving Central Group OA-4939/TSR-1 (Container RC1, Multi-Channel Crypto)	1-33/1-34	1-30	Teletype Central AN/TGC-19 (Container RJ2-NTX Send)1-89/1-90
1-13	Maintenance Equipment Group OA-4941/TSR-1 (Container RD1-Electronic Repair)	1-37/1-38	SECTION II—INSTALLATION		
1-14	Supply Center OA-4942/TSR-1 (Container RD2-Supply)	1-39/1-40	2-1	Antenna Field, Receiving Central AN/TSR-12-3/2-4
1-15	Teletype Central AN/TGC-17 (Container RE1, Unclassified Control, Left Side)	1-43/1-44	2-2	Signal Grounding, KW-26 Order-Wire Control Circuit, RB2 and RB3	2-5
1-16	Teletype Central AN/TGC-17 (Container RE1, Unclassified Control, Right Side)	1-45/1-46	2-3	Equipment Rack Grounding Receiving Central AN/TSR-1	2-6
1-17	Receiving Central Group OA-4943/TSR-1 (Container RE2, HICOM Voice & Microwave)	1-47/1-48	2-4	Rack Grounding Details, Receiving Central	2-7
1-18	Receiving Central Group OA-4944/TSR-1 (Container RE3, Receivers, Right Side)	1-51/1-52	2-5	Earth Ground Grid, Receiving Central AN/TSR-12-9/2-10
			2-6	Power Distribution, From Generators to GR1, Receiving Central AN/TSR-12-11/2-12

SECTION II—INSTALLATION (CONT)

Figure	Title	Page
2-7	Power Distribution From GR1, Receiving Central AN/TSR-1	.2-13/2-14
2-8	Power Line Interference Filter, Receiving Central	.2-15/2-16
2-9	Power Distribution, Container RB2	.2-17/2-18
2-10	Power Cabling, RB2	.2-19/2-20
2-11	Power Distribution, Container RF1	.2-21/2-22
2-12	Power Cabling, Container RF1	.2-23/2-24

SECTION III—SYSTEM OPERATION

3-1	Basic Tone Converter Circuit	3-3
3-2	Typical Trip Control Circuit	3-4
3-3	Typical Audio Circuit Program Patches	3-5
3-4	Typical DC Circuit Program Patches	3-5
3-5	Typical Point-to-Point Receive Circuit	3-7/3-8
3-6	Typical Point-to-Point Send Circuit	3-9/3-10
3-7	Typical 4-Channel Multiplex Send Circuit	.3-13/3-14
3-8	Typical 4-Channel Multiplex Receive Circuit	.3-17/3-18
3-9	Typical CW Send/Receive Circuit	.3-19/3-20
3-10	Typical Search and Rescue Send/Receive circuit	.3-23/3-24
3-11	Typical Facsimile Send/Receive Circuit	.3-25/3-26
3-12	Local KW-26 RA3, Typical Programming	.3-29/3-30
3-13	Remote KW-26 RA3, Typical Programming	.3-31/3-32
3-14	Voice Operating Position RE2, Front View	3-33
3-15	Voice Operating Position RE2, Receive Block Diagram	3-35/3-36
3-16	Voice Operating Position, RE2, Send Block Diagram	3-37/3-38
3-17	CW Operating Position RF2, Front View	3-39
3-18	Receiver Control Panel RF2 and RF3, Functional Block Diagram	3-41/3-42
3-19	Transmitter Control Panel, RF2 and RF3, Functional Block Diagram	3-43
3-20	Voice and CW Operation Positions RF3, Front View	3-44
3-21	Station Internal Order-Wire System, Block Diagram	3-47/3-48
3-22	Station Internal Order-Wire RA3, Typical Programming	3-49/3-50
3-23	Code Format Converter Systems RF2, Block Diagram	3-53/3-54
3-24	KW-26 Order-Wire Control Panel, Front View	3-55

SECTION III—SYSTEM OPERATION (CONT)

Figure	Title	Page
3-25	KW-26 Order-Wire Control Circuit, Block Diagram	3-56
3-26	Point-to-Point Order Wire Control Circuit, Block Diagram	3-57/3-58

SECTION IV—TECHNICAL DESCRIPTION OF SPECIAL CIRCUITS

4-1	TT-331 Tone Converter Panel, Isometric View	4-2
4-2	TT-331 Tone Converter Panel, Wiring Diagram	4-3/4-4
4-3	TT-333 Tone Converter Panel, Isometric View	4-5
4-4	TT-333 Loop Supply and Relay Panel, Isometric View	4-5
4-5	TT-333 Loop Supply-Relay Panel, Wiring Diagram	4-7/4-8
4-6	AN/FGC-59 TD-Monitor Tandem Operation, Block Diagram	4-9
4-7	KW-26 Tone Converter Drawer, Right Hand, Isometric View	4-10
4-8	KW-26 Tone Converter Drawer, Right Hand, Wiring Diagram	4-11/4-12
4-9	KW-26 Typical Circuit Cabling Diagram	4-13/4-14
4-10	KW-26 Tone Converter Drawer, Left-Hand, Isometric View	4-15
4-11	KW-26 Tone Converter Drawer, Left Hand, Wiring Diagram	4-17/4-18
4-12	KW-26 Equipment Rack, RB2 and RB3, Wiring Diagram	4-19
4-13	Modified KW-26 Tone Converter, Isometric View	4-20
4-14	Modified KW-26 Tone Converter, Wiring Diagram	4-21/4-22
4-15	KW-26 Order-Wire Control Panel, Wiring Diagram	4-23/4-24
4-16	KW-26 Order-Wire Control Panel, Simplified Schematic Diagram	4-25/4-26
4-17	KW-26 Order-Wire Control Panel Switches	4-27
4-18	KW-26 Order-Wire Control Rack, Typical Wiring Diagram	4-28
4-19	AN/FGC-60/19 Demodulator Tone Converter Drawer, Isometric View	4-29
4-20	AN/FGC-60/19 Demodulator Tone Converter Drawer, Wiring Diagram	4-30
4-21	AN/FGC-60/19 Modulator Tone Converter Drawer, Isometric View	4-31
4-22	AN/FGC-60/19 Modulator Tone Converter Drawer, Wiring Diagram	4-33/4-34
4-23	AN/FGC-60/22 Demodulator Tone Converter Drawer, Isometric View	4-35
4-24	AN/FGC-60/22 Demodulator Tone Converter Drawer, Wiring Diagram	4-37/4-38
4-25	AN/FGC-60/22 Modulator Tone Converter Drawer, Isometric View	4-39

**SECTION IV—TECHNICAL DESCRIPTION
OF SPECIAL CIRCUITS (CONT)**

Figure	Title	Page
4-26	AN/FGC-60/22 Modulator Tone Converter Drawer, Wiring Diagram	4-41/4-42
4-27	AN/FGC-60/23A Demodulator Tone Converter Drawer, Wiring Diagram	4-43
4-28	AN/FGC-60/24 Tone Converter Drawer, Isometric View	4-44
4-29	AN/FGC-60/24 Tone Converter Drawer, Wiring Diagram	4-45/4-46
4-30	AN/UGC-1A BLACK Tone Converter Drawer, Isometric View	4-47
4-31	AN/UGC-1A BLACK Tone Converter Drawer, Wiring Diagram	4-48
4-32	AN/UGC-1A RED Tone Converter Drawer, Isometric View	4-49
4-33	AN/UGC-1A RED Tone Converter Drawer, Wiring Diagram	4-51/4-52
4-34	AN/UGC-1A RED Tone Converter and Loop Supply, Interconnecting Wiring	4-53/4-54
4-35	AN/UGC-1A RED Loop Supply Drawer, Isometric View	4-55
4-36	AN/UGC-1 RED Loop Supply Drawer, Wiring Diagram	4-56
4-37	AN/UGC-1A Typical Circuit, Block Diagram	4-57/4-58
4-38	AN/UGC-1A Racks RC1.8, 1.11 and 1.14, Wiring Diagram	4-59
4-39	KW-37 BLACK Tone Converter Drawer, Isometric View	4-60
4-40	KW-37 BLACK Tone Converter Drawer, Wiring Diagram	4-61/4-62
4-41	KW-37 Tone Converter/Loop Supply Rack, RB1.32, Wiring Diagram	4-63/4-64
4-42	KW-37 Typical Circuit Cabling, Block Diagram	4-65/4-66
4-43	KW-37 RED Tone Converter Drawer, Isometric View	4-67/4-68
4-44	KW-37 RED Tone Converter Drawer, Wiring Diagram	4-69/4-70
4-45	KW-37 Order-Wire Rack RB1.26, Wiring Diagram	4-71
4-46	Point-to-Point Order-Wire Tone Converter Panel, Isometric View	4-72
4-47	Point-to-Point Order-Wire Tone Converter Panel, Wiring Diagram	4-73
4-48	Point/Point Order-Wire & Monitor TTY Rack RE1.21, Wiring Diagram	4-74
4-49	RED Point/Point Order-Wire & Monitor Rack, Typical Wiring Diagram	4-75
4-50	Internal O/W Tone Converter Panel, Isometric View	4-76

**SECTION IV—TECHNICAL DESCRIPTION
OF SPECIAL CIRCUITS (CONT)**

Figure	Title	Page
4-51	Internal Order-Wire Tone Converter Panel, Wiring Diagram	4-77
4-52	Internal Order-Wire & Monitor TTY Rack RE1.23, Wiring Diagram	4-78
4-53	TTY Monitor Tone Converter Panel, Isometric View	4-79
4-54	TTY Monitor Tone Converter Panel, Wiring Diagram	4-80
4-55	Typical Monitor TTY Rack, Wiring Diagram	4-81
4-56	TT-176A Monitor Tone Converter Drawer RF2.17, Isometric View	4-82
4-57	TT-176A Tone Converter Drawer, RF2117, Wiring Diagram	4-83
4-58	AN/UGC-5 and AN/UGC-6 Tone Converter Panel, Isometric View	4-84
4-59	AN/UGC-5 and AN/UGC-6 Tone Converter Panel, Wiring Diagram	4-85/4-86
4-60	AN/UGC-8, TT-47, TT-171 Tone Converter Panel, Isometric View	4-87/4-88
4-61	AN/UGC-8, TT-47, TT-171 Tone Converter Panel, Wiring Diagram	4-89/4-90
4-62	2067 System Tone Converter Drawer RE2.27, Isometric View	4-91
4-63	2067 System Tone Converter Drawer RE2.27, Wiring Diagram	4-92
4-64	FSK Tone Converter Panel, Isometric View	4-93
4-65	FSK Diversity Tone Converter Panel (Dry Key), Wiring Diagram	4-94
4-66	FSK Tone Converter Panel (Wet Key), Wiring Diagram	4-95
4-67	FSK Equipment Rack RE3.15, Wiring Diagram	4-96
4-68	FSK Equipment Racks RE3.17, 3.21, 3.23 and 3.27, Wiring Diagram	4-97
4-69	FSK Equipment Racks RE3.19, and RE3.25, Wiring Diagram	4-98
4-70	FSK Equipment Rack RE3.29, Wiring Diagram	4-99
4-71	FSK Equipment Rack RE3.31, Wiring Diagram	4-100
4-72	FSK Equipment Rack RE3.33, Wiring Diagram	4-101
4-73	AN/GGM-1 Tone Converter Panel, Isometric View	4-102
4-74	AN/GGM-1 Tone Converter Panel, Wiring Diagram	4-103
4-75	RED Tone Converter Drawer, RA3.16, Wiring Diagram	4-104
4-76	RED Tone Converter Drawer, RA3.16, Wiring Diagram	4-105

SECTION IV—TECHNICAL DESCRIPTION OF SPECIAL CIRCUITS (CONT)

Figure	Title	Page
4-77	BLACK Tone Converter Drawer RA3.15, Wiring Diagram	4-106
4-78	Loop Supply Drawer, 6 Unit, RA3.15 & 3.16, Wiring Diagram	4-107
4-79	Loop Supply Drawer, 4 Unit, RA3.15 and RA3.16, Wiring Diagram	4-108
4-80	RED Control Rack RA3.16, Wiring Diagram	4-109
4-81	660A Tone Converter Drawer RF2.17, Isometric View	4-110
4-82	660A Tone Converter Drawer RF2.17, Wiring Diagram	4-111
4-83	660A Code Format Converter Rack RF2.17, Wiring Diagram	4-112
4-84	HW-19 Tone Converter Drawer, Isometric View	4-113
4-85	HW-19 Tone Converter Drawer, Wiring Diagram	4-114
4-86	HW-19/10 Rack RA2.6, Wiring Diagram	4-115
4-87	Microphone Control Unit RE2, Wiring Diagram	4-116
4-88	SPU-2 Connections to Audio Control Circuits	4-117/4-118
4-89	RE2 Receiver Control Panel, Schematic Diagram	4-119/4-120
4-90	RE2 Transmitter Control Panel, Schematic Diagram	4-121/4-122
4-91	RF2 and RF3 Receiver Control Panel (Typical), Schematic Diagram	4-123/4-124
4-92	RF2 Receiver Control Panel, Schematic Diagram	4-125/4-126
4-93	RF2 and RF3 Transmitter Con- trol Panel, Schematic Diagram (Typical CW Circuits)	4-127/4-128
4-94	RF3 Transmitter Control Panel, Audio Circuit, Schematic Dia- gram (Typical for three positions)	4-129/4-130
4-95	RF3 Transmitter Control Panel, Audio Output Circuit, Schematic Diagram	4-131/4-132
4-96	RF3 Receiver Control Panel, Schematic Diagram (Remote Line and Local Audio Inputs	4-133/4-134
4-97	RF3 Receiver Control Panel, Schematic Diagram (Headphone Circuits)	4-135/4-136

SECTION IV—TECHNICAL DESCRIPTION OF SPECIAL CIRCUITS (CONT)

Figure	Title	Page
4-98	RF3 Receiver Control Panel, Schematic Diagram (Headphone Indicator Circuits)	4-137/4-138
4-99	RF3 Receiver Control Panel, Schematic Diagram (Remote Output Circuits)	4-139/4-140
4-100	RF3 Receiver Control Panel, Schematic Diagram (Speaker Muting Circuits)	4-141/4-142
4-101	RF2 Receiver Control Panels, Interconnecting Diagram	4-143/4-144
4-102	RF2 Transmitter Control Panels, Interconnecting Diagram	4-145/4-146
4-103	RF3 Receiver Control Panels, Interconnecting Diagram	4-147/4-148
4-104	RF3 Transmitter Control Panels, Interconnecting Diagram	4-149
4-105	Control Panel Switch, Contact Configuration	4-150
4-106	FAX Position RE4.31 and 4.33, Wiring Diagram	4-151
4-107	FAX Equipment Rack RE4.27, Wiring Diagram	4-152
4-108	Printer Test Bench RH1.1, Wiring Diagram	4-153/4-154
4-109	Reperforator Test Bench, RH1.3, Wiring Diagram	4-155/4-156
4-110	Transmitter Distributor Test Bench RH1.5, Wiring Diagram	4-157/4-148
4-111	Voice Equipment Rack RE2.21, Wiring Diagram	4-159
4-112	VHF Equipment RE2.27, Wiring Diagram	4-160
4-113	UHF Equipment Rack RE2.29, Wiring Diagram	4-161
4-114	AN/SRC-20 Rack RE2.31, Wiring Diagram	4-162
4-115	Antenna Patch & Multicoupler Rack, RA3.19, Rack Wiring	4-163
4-116	TD-411/UGC Demultiplexer Rack RE3.11 (2030 System), Wiring Diagram	4-164
4-117	AN/FGC-17 Multiplexer VF Cabling Connections to De- multiplexer Equipment Rack 3, Typical of RE2 and TC1	4-165/4-166
4-118	AN/FGC-17 Multiplexer VF Cabling Connections to Multi- plexer Equipment Rack 1, Typical of RE2 and TC1	4-167/4-168

VOLUME III TRANSMITTING CENTRAL AN/TST-2

LIST OF ILLUSTRATIONS

SECTION I—DESCRIPTION OF CONTAINERS			SECTION I—DESCRIPTION OF CONTAINERS		
Figure	Title	Page	Figure	Title	Page
1-1	Site Plan, Transmitting Central AN/TST-2, Containers.	1-1	1-19	Interconnect Group OA-4916/TST-2, (Container TD1), Isometric View.	1-41/1-42
1-2	Control-Monitor Group OA-4915/TST-2, (Container TC1, Left Side) Isometric View	1-3/1-4	1-20	Interconnect Group OA-4918/TST-2 (Container TG1), Isometric View.	1-43/1-44
1-3	Control-Monitor Group OA-4915/TST-2, (Container TC1, Right Side) Isometric View.	1-5/1-6	1-21	Maintenance Equipment Group OA-4917/TST-2, (Container TF1), Isometric View.	1-45/1-46
1-4	Radio Transmitting Set AN/TRT-17, (Typical of TA1, TA2, TC4 and TG2), Isometric View	1-7/1-8			
1-5	Radio Transmitting Set AN/TRT-17, (Typical of TB2, TB3, and TD4), Isometric View	1-9/1-10			
1-6	AN/FRT-39D Transmitter, Front Elevation	1-11	2-1	Antenna Field Plot Plan, Transmitting Central AN/TST-2.	2-3/2-4
1-7	Radio Transmitting Set AN/TRT-18 (Typical of TB1, TD2, TD3, TH1, and TH2), Isometric View	1-13/1-14	2-2	Open Wire Transmission Line Pole Locations, Transmitting Central AN/TST-2	2-5/2-6
1-8	Radio Transmitting Set AN/TRT-18, (Typical of TC2, TC3 and TG3), Isometric View	1-15/1-16	2-3	Transmission Line Pole Types, Transmitting Central AN/TST-2.	2-7/2-8
1-9	AN/FRT-40B Transmitter, Front Elevation	1-17	2-4	Transmission Line Guying and Crossarms, Transmitting Central AN/TST-2	2-9/2-10
1-10	Radio Transmitting Set AN/TRT-23, (Container TA3, Right Side), Isometric View	1-19/1-20	2-5	Transmission Line Junction Types, Transmitting Central AN/TST-2	2-11/2-12
1-11	Radio Transmitting Set AN/TRT-23, (Container TA3, Left Side), Isometric View	1-21/1-22	2-6	Typical Antenna Field Balun Installation, AN/TST-2	2-13/2-14
1-12	AN/URT-19 (V) Transmitter, Balanced/Unbalanced Output, Front Elevation	1-23	2-7	Coaxial Patch Panel TD1 and TG1, Front View	2-15/2-16
1-13	AN/URT-19(V) Transmitter, Unbalanced Output Only, Front Elevation	1-23	2-8	Coaxial Patch Panel TD1 and TG1, Rear View	2-17/2-18
1-14	Radio Transmitting Set AN/TRT-24 (Container TH3, AN/FRT-62 Installation), Isometric View	1-27/1-28	2-9	Interior Ground Bus, Transmitting Central AN/TST-2 Containers.	2-19/2-20
1-15	Radio Transmitting Set AN/TRT-25 (Container TH4, AN/FRT-61 Installation), Isometric View	1-29/1-30	2-10	Typical Transmitter Container Ground Installation Details.	2-21/2-22
1-16	Radio Transmitting Set AN/TRT-25 (Container TG4 LP Filter and Blower Installation), Isometric View	1-31/1-32	2-11	AN/TRT-24, Container TH3, Ground Installation Details.	2-23/2-24
1-17	Radio Transmitting Set AN/TRT-19, (Container TE1), Isometric View.	1-35/1-36	2-12	Ground System, Transmitting Central AN/TST-2	2-25/2-26
1-18	Antenna Coupler Group OA-4940/TST-2 (Helix Container), Isometric View.	1-37/1-38	2-13	Electric Power Plant AN/TSQ-55, Power Cabling	2-27/2-28
			2-14	Power Distribution From GT1, Transmitting Central AN/TST-2.	2-41/2-42
			2-15	Typical AN/TRT-17 Power Cabling	2-43/2-44
			2-16	Typical AN/TRT-18 Power Cabling	2-45/2-46

SECTION II—INSTALLATION

SECTION II—INSTALLATION (CONT)

Figure	Title	Page
2-17	AN/TRT-24 Power and Signal Cabling	2-47/2-48
2-18	AN/TRT-25 Power and Control Cabling, Container TH4	2-49/2-50
2-19	AN/TRT-25 Power and Control Cabling, Container TG4	2-51/2-52

SECTION III—DESCRIPTION OF SPECIAL CIRCUITS AND MODIFICATIONS

3-1	Typical, Transmitter, Indicator Alarm, Control and Monitor Circuits, Simplified Schematic Diagram	3-2
3-2	Transmitter Radiation Indicator and Alarm Circuits, Wiring Diagram	3-3/3-4
3-3	Transmitter Alarm Panel, Schematic Diagram	3-7/3-8
3-4	AN/URT-19(V), Modified Interlock Circuit, Schematic Diagram	3-9/3-10

SECTION III—DESCRIPTION OF SPECIAL CIRCUITS AND MODIFICATIONS (CONT)

Figure	Title	Page
3-5	High-Frequency Transmitter Exciter Harness Modifications	3-11/3-12
3-6	AN/URT-19(V) Exciter Frame, Wiring Diagram	3-13
3-7	AN/URT-19(V) Transmitter Frame (Balanced/Unbalanced), Wiring Diagram	3-14
3-8	AN/URT-19(V) Transmitter Frame (Unbalanced Only), Wiring Diagram	3-15/3-16
3-9	AN/URT-19(V) APP-4 Modifications, Schematic Diagram	3-17/3-18
3-10	AN/FRT-62 Driver Switching, Schematic Diagram	3-19/3-20
3-11	TD-410/UGC Multiplexer Rack TC1. 11, Wiring Diagram	3-21/3-22
3-12	Typical Point-to-Point Send Circuit	3-23/3-24
3-13	Typical 4-Channel Multiplex Send Circuit	3-25/3-26
3-14	Typical CW Circuit	3-27/3-28
3-15	Typical Voice Circuit	3-29/3-30

VOLUME I
U. S. NAVY TRANSPORTABLE COMMUNICATION SYSTEM AN/TSC-35

LIST OF TABLES

**SECTION I—DESCRIPTION AND LEADING
PARTICULARS**

Table	Title	Page
1-1	Communication System AN/ TSC-35 (SYM-2005-TR) Major Components	1-5
1-2	Air Conditioning Units Installed. . .	1-54
1-3	Communication System AN/ TSC-35 Antennas	1-55
1-4	AN/TSC-35 Equipment List	1-65/1-66
1-5	Portable Tool Kit	1-83
1-6	Electronic Work Bench Kit	1-84
1-7	Antenna Field Tool Kits	1-85
1-8	Heavy Duty Work Bench Kit.	1-87
1-9	Miscellaneous Maintenance Material	1-89

VOLUME II
RECEIVING CENTRAL AN/TSR-1

LIST OF TABLES

SECTION I—DESCRIPTION OF AN/TSR-1 CONTAINERS			SECTION II—INSTALLATION (CONT)		
Table	Title	Page	Table	Title	Page
1-1	Test Equipment Supplied, OA-4936/TSR-1 (Container RA2) . . .	1-8	2-8	Primary Power Distribution OA-4941/TSR-1 (Container RD1) . . .	2-35
1-2	Test Equipment Supplied, OA-7041/TSR-1 (Container RA3) . . .	1-17	2-9	Primary Power Distribution OA-4942/TSR-1 (Container RD2) . . .	2-35
1-3	Test Equipment Supplied, OA-4941/TSR-1 (Container RD1) . . .	1-36	2-10	Primary Power Distribution AN/TGC-17 (Container RE1)	2-36
1-4	Test and Maintenance Equipment Supplied, OA-4967/TSR-1 (Container RH1)	1-80	2-11	Primary Power Distribution OA-4943/TSR-1 (Container RE2) . . .	2-37
			2-12	Primary Power Distribution OA-4944/TSR-1 (Container RE3) . . .	2-38
			2-13	Primary Power Distribution AN/TSR-2 (Container RE4)	2-40
			2-14	Primary Power Distribution OA-4945/TSR-1 (Container RF1) . . .	2-42
			2-15	Primary Power Distribution OA-4950/TSR-1 (Container RF2) . . .	2-43
			2-16	Primary Power Distribution OA-4951/TSR-1 (Container RF3) . . .	2-44
			2-17	Primary Power Distribution OA-4966/TSR-1 (Container RG1) . . .	2-45
			2-18	Primary Power Distribution OA-4967/TSR-1 (Container RH1) . . .	2-45
			2-19	Primary Power Distribution AN/TGC-18 (Container RJ1)	2-46
			2-20	Primary Power Distribution AN/TGC-19 (Container RJ2)	2-47
SECTION II—INSTALLATION					
2-1	Primary Power Distribution OA-3887/TSR-1 (Container RA1) . . .	2-25			
2-2	Primary Power Distribution OA-4936/TSR-1 (Container RA2) . . .	2-26			
2-3	Primary Power Distribution OA-7041/TSR-1 (Container RA3) . . .	2-27			
2-4	Primary Power Distribution AN/TGC-16 (Container RB1)	2-28			
2-5	Primary Power Distribution OA-4937/TSR-1 (Container RB2) . . .	2-30			
2-6	Primary Power Distribution OA-4938/TSR-1 (Container RB3) . . .	2-31			
2-7	Primary Power Distribution OA-4939/TSR-1 (Container RC1) . . .	2-34			

VOLUME III
TRANSMITTING CENTRAL AN/TST-2

LIST OF TABLES

SECTION I—DESCRIPTION OF CONTAINERS			SECTION II—INSTALLATION (CONT)		
Table	Title	Page	Table	Title	Page
1-1	Test Equipment Supplied, OA-4917/TST-2, Container TF1 . . .	1-39	2-6	Primary Power Distribution AN/TRT-18 (Containers TC2, TC3, TD2, TD3 and TG3).	2-34
			2-7	Primary Power Distribution OA-4916/TST-2 (Container TD1) . . .	2-34
			2-8	Primary Power Distribution AN/TRT-19 (Container TE1).	2-35
			2-9	Primary Power Distribution OA-4917/TST-2 (Container TF1). . . .	2-35
			2-10	Primary Power Distribution OA-4918/TST-2 (Container TG1). . . .	2-36
			2-11	Primary Power Distribution AN/TRT-25 (Container TG4).	2-37
			2-12	Primary Power Distribution AN/TRT-20 (Container TH2).	2-37
			2-13	Primary Power Distribution AN/TRT-24 (Container TH3).	2-38
			2-14	Primary Power Distribution AN/TRT-25 (Container TH4).	2-38
			2-15	Primary Power Distribution OA-4940 (Helix Container).	2-39/2-40
2-1	Primary Power Distribution AN/TRT-17 (Containers TA1, TA2, TG2).	2-29			
2-2	Primary Power Distribution AN/TRT-23 (Container TA3)	2-29			
2-3	Primary Power Distribution AN/TRT-18 (Containers TB1 & TH1) . . .	2-31			
2-4	Primary Power Distribution AN/TRT-17 (Containers TB2, TB3, TC4 and TD4).	2-31			
2-5	Primary Power Distribution OA-4915/TST-2 (Container TC1)	2-32			

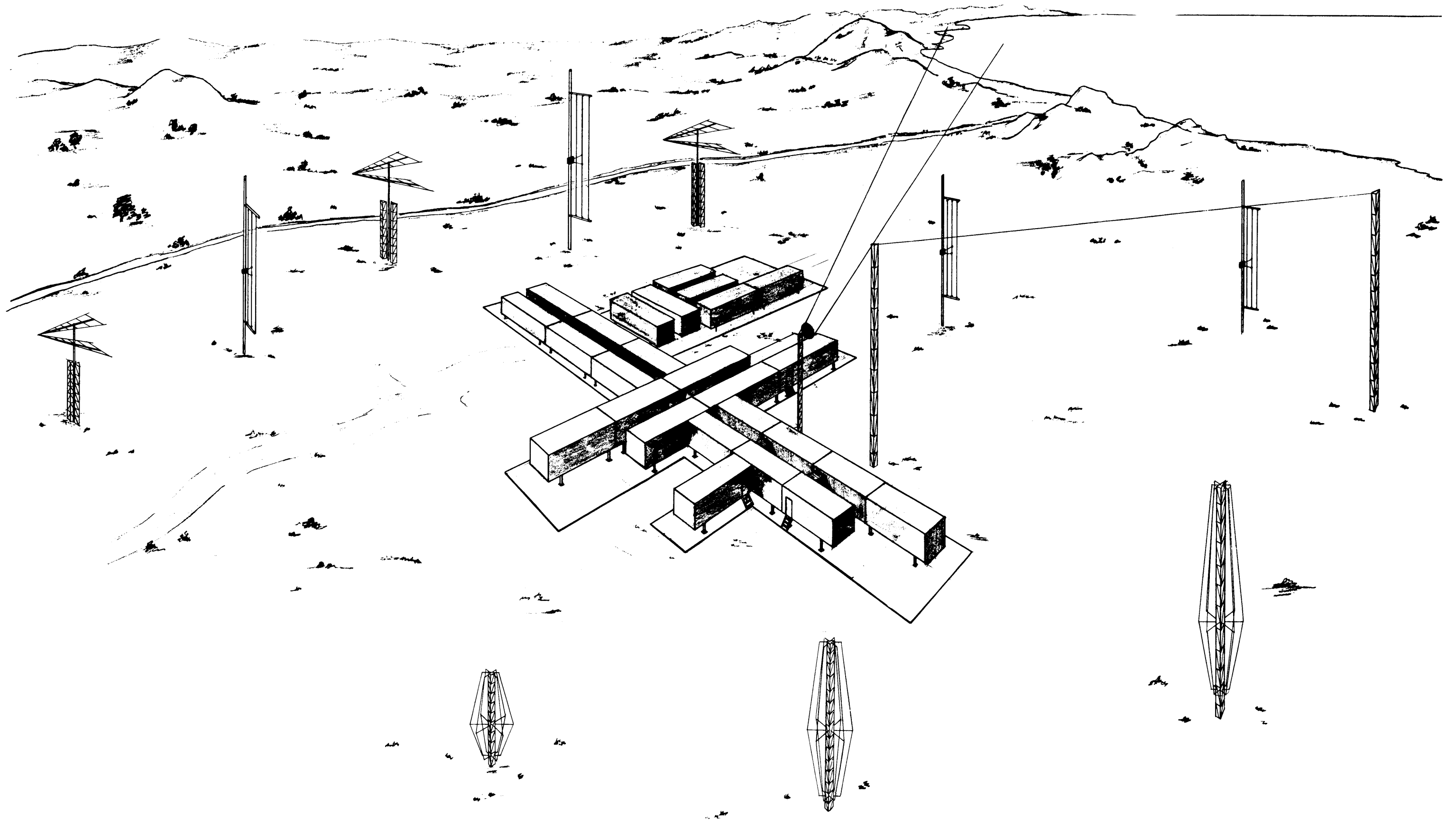

Figure 1-1. Receiving Central, AN/TSR-1
Artist's Concept

AN/TSC-35

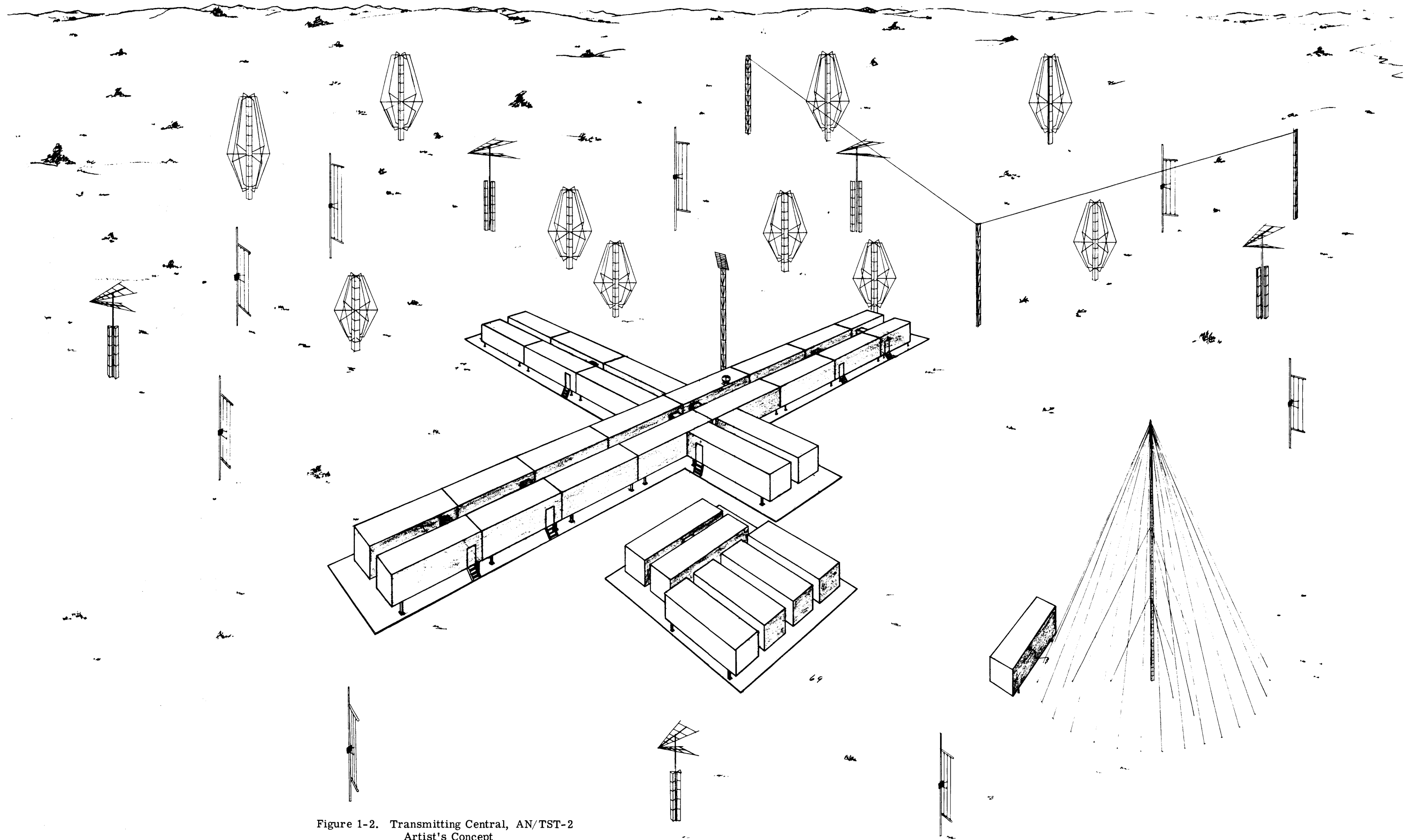

Figure 1-2. Transmitting Central, AN/TST-2
Artist's Concept

VOLUME I
U. S. NAVY TRANSPORTABLE COMMUNICATIONS SYSTEM AN/TSC-35
SECTION I
DESCRIPTION AND LEADING PARTICULARS

1-1. INTRODUCTION.

The U. S. Navy Transportable Communication System AN/TSC-35 (SYM-2005) is a complete communication station consisting of a Receiving Central AN/TSR-1 (COMM CENTER/Receiver site) and a Transmitting Central AN/TST-2 (Transmitter site). (See artists concept of completed sites, figures 1-1 and 1-2.) Communication equipment, repair, supply, and primary power facilities at both sites are housed in 40-foot containers which have been designed for land or sea transport and for rapid on-site installation. Associated transmitting and receiving antennas, primarily in kit form, can likewise be installed in a minimum of time. The assembled communication system provides point-to-point, ship-shore, air-ground and broadcast communication facilities, with cryptographic capability, of the extent and quality comparable to a fixed shore communication station.

1-2. PURPOSE.

The purpose of Communication System AN/TSC-35 is to provide primary communication support for the U.S. Fleet and other Governmental Agencies in the shortest possible period of time.

1-3. LOCATION.

Communication System AN/TSC-35 may be installed at any required location provided sufficient land area is available to accommodate the desired antenna installation.

1-4. TRANSPORTABILITY.

The AN/TSC-35 containers are transportable over land and water. Specially designed lowbed platform trailers are provided for transporting containers over land surfaces. For ship loading and unloading, the containers are equipped with lifting pins, and special container lifting slings are furnished.

1-5. OPERATIONAL CAPABILITY.

Communication System AN/TSC-35 is designed to provide the following circuits and facilities:

1-6. RELAY FACILITIES.

- a. 48-line torn-tape NTX class relay with 18-receive page-copy monitors.
- b. 18-line torn-tape HICOM/ASC relay with 12-receive page-copy monitors.

1-7. RECEIVERS.

- a. 9 synthesized SSB diversity receivers with provisions for installing additional units.
- b. 1 synthesized SSB non-diversity receiver.
- c. 13 diversity RATT receiver/converter bays, one equipped for low-frequency RATT operation.
- d. 3 monitor-receiver bays each with 5 receivers and 1 converter.
- e. 6 CW/Ship-Shore send/receive circuits and one low-frequency distress circuit.
- f. 6 HICOM and point-to-point voice terminals.
- g. 9 air/ground, search and rescue circuits; 6 high-frequency and 3 VHF/UHF.

1-8. CRYPTOGRAPHIC FACILITIES.

- a. 64 TSEC/KW-26C send/receive.
- b. 4 TSEC/KW-37 send/receive.
- c. 3 TSEC/KW-22 send/receive bays.
- d. 2 TSEC/HW-10/19.
- e. 2 AN/GGA-1.

In addition, space has been provided for 4 TSEC/KG-14 and 3 TSEC/KW-7 and associated equipments.

1-9. TERMINAL EQUIPMENT.

- a. Eight 16-channel full-duplex tone-diversity telegraph units.
- b. Four 16-channel non-diversity full-duplex tone telegraph units.
- c. Three sets 8-narrow 4-wideband send non-diversity CCL tone telegraph units from the Receiving Central to the Transmitting Central.
- d. One set 8-narrow 4-wideband send non-diversity CCL tone telegraph unit from the Transmitting Central to the Receiving Central.
- e. One 60-send and 24-receive channel CCL voice terminal at the Receiving Central (expandable to 60-send and 60-receive channels).

f. One 24-send and 60-receive channel CCL voice terminal at the Transmitting Central (expandable to 60-send and 60-receive channels).

g. Sixteen 3-to-6-kc multiplexer units at the Transmitting Central.

h. Sixteen 6-to-3-kc demultiplexer units at the Receiving Central.

1-10. TRANSMITTERS.

a. Ten 1-kilowatt (PEP) synthesized SSB Transmitters.

b. Thirty-seven 10-kilowatt (PEP) synthesized SSB transmitters.

c. Sixteen 40-kilowatt (PEP) synthesized SSB transmitters.

d. One 200-kilowatt (PEP) synthesized SSB transmitter.

e. Two 2-kilowatt low-frequency transmitters.

f. One 15-kilowatt low-frequency transmitter.

g. One 50-kilowatt low-frequency transmitter.

h. 80-line transmitting antenna patching facility equipped with inter-patch panel trunking.

i. Remote RF monitoring and remote visual and audible alarm facilities at a transmitter control center for all transmitters.

1-11. CIRCUIT-PROGRAMMING FACILITIES.

a. The following main frame circuit-programming facilities are provided:

1. 5760-pair BLACK program board.

2. 2880-pair RED program board.

b. The following intermediate distribution frame circuit-programming facilities are provided:

1. 1440-pair RECEIVERS audio program board.

2. 1440-pair TRANSMITTERS audio program board.

3. 1440-pair TRANSMITTERS D-C program board.

c. The following special distribution frame circuit-programming facilities are provided:

1. 360-pair HICOM voice program board.

2. 216-pair audio and 108-pair D-C special receiver RED program board.

3. 216-pair audio and 108-pair D-C special receiver BLACK program board.

1-12. PATCHING FACILITIES.

a. 384-send/384-receive normal-through BLACK circuit monitor patchboard with 192-miscellaneous circuit appearances.

b. 144-send/144-receive normal-through RED circuit monitor patchboard with remote and alarm indication each circuit, and 96-miscellaneous circuit appearances.

c. 24-line send/24-line receive normal-through HICOM Voice circuit monitor patchboard with 48-miscellaneous circuit appearances.

d. 96-line send/96-line receive normal-through Receivers monitor patchboard with 48-miscellaneous circuit appearances.

e. 120-line send/120-line receive normal-through transmitter circuit monitor patchboard with 48-miscellaneous circuit appearances.

f. 96-line transmitters DC circuit monitor patchboard with 144-miscellaneous DC circuit appearances.

g. Two special receiver monitor patchboards, one RED and one BLACK, each consisting of 24-line audio and 24-line DC circuits with 24-miscellaneous DC circuit appearances.

1-13. WEATHER FACILITIES.

4 send/receive weather positions.

1-14. MULTIPLEX FACILITIES.

3 AN/UGC-1A time division TTY multiplex units.

1-15. FACSIMILE.

a. One facsimile transceiver with associated keyer.

b. One facsimile continuous page printer with associated converter.

1-16. PRIMARY POWER FACILITIES.

208-volt, 60-cycle, 3-phase, 4-wire primary power is supplied at each site, with power capability as follows:

a. Receiving Central. 2010 kilowatts standard power system and 400-kilowatts no-break power system.

b. Transmitting Central. 4020 kilowatts standard.

1-17. REPAIR FACILITIES.

a. Cryptographic repair area.

b. Teletype repair shop.

c. Two electronic repair shops, one at each site.

d. One mobile workshop trailer.

1-18. SUPPLY FACILITIES.

One and one-half containers at receiver site and one-half container at transmitter site.

1-19. RECEIVER SITE ANTENNA FACILITIES.

- a. 6 Rotatable Log-Periodic and 2 fixed Log-Periodic.
- b. 3 Conical Monopole.
- c. 11 Vertical Folded Doublet.
- d. 2 Dual-Nested Rhombics.
- e. 2 Single Rhombic.
- f. 2 Low-Frequency Long-Wire.

1-20. TRANSMITTER SITE ANTENNA FACILITIES.

- a. 14 Vertical Folded Doublet.
- b. 29 Conical Monopole (includes one high-power CM).

- c. 10 Rotatable Log Periodic.
- d. 6 Dual-Nested Rhombics.
- e. 2 Single Rhombic.
- f. 2 Low-Frequency Long-Wire.
- g. 1 Low-Frequency 630-foot Pan Polar.
- h. 1 Low-Frequency 359-foot Pan Polar.

1-21. GENERAL DESCRIPTION OF AN/TSC-35.

Communication System AN/TSC-35 is comprised of 26 containers at the Receiving Central AN/TSR-1 arranged as shown in figure 1-3, 30 containers (and a Helix container which is not shown) at the Transmitting Central AN/TST-2 arranged as shown in figure 1-4, and one mobile workshop trailer. The containers at each site (except for the power group, the mobile workshop trailer and Helix container) are joined together end-to-end to form wings, and the wings are joined allowing internal access from wing to wing. The containers are mounted on adjustable support assemblies that allow for all joined containers to be maintained at the same level. The containers are identi-

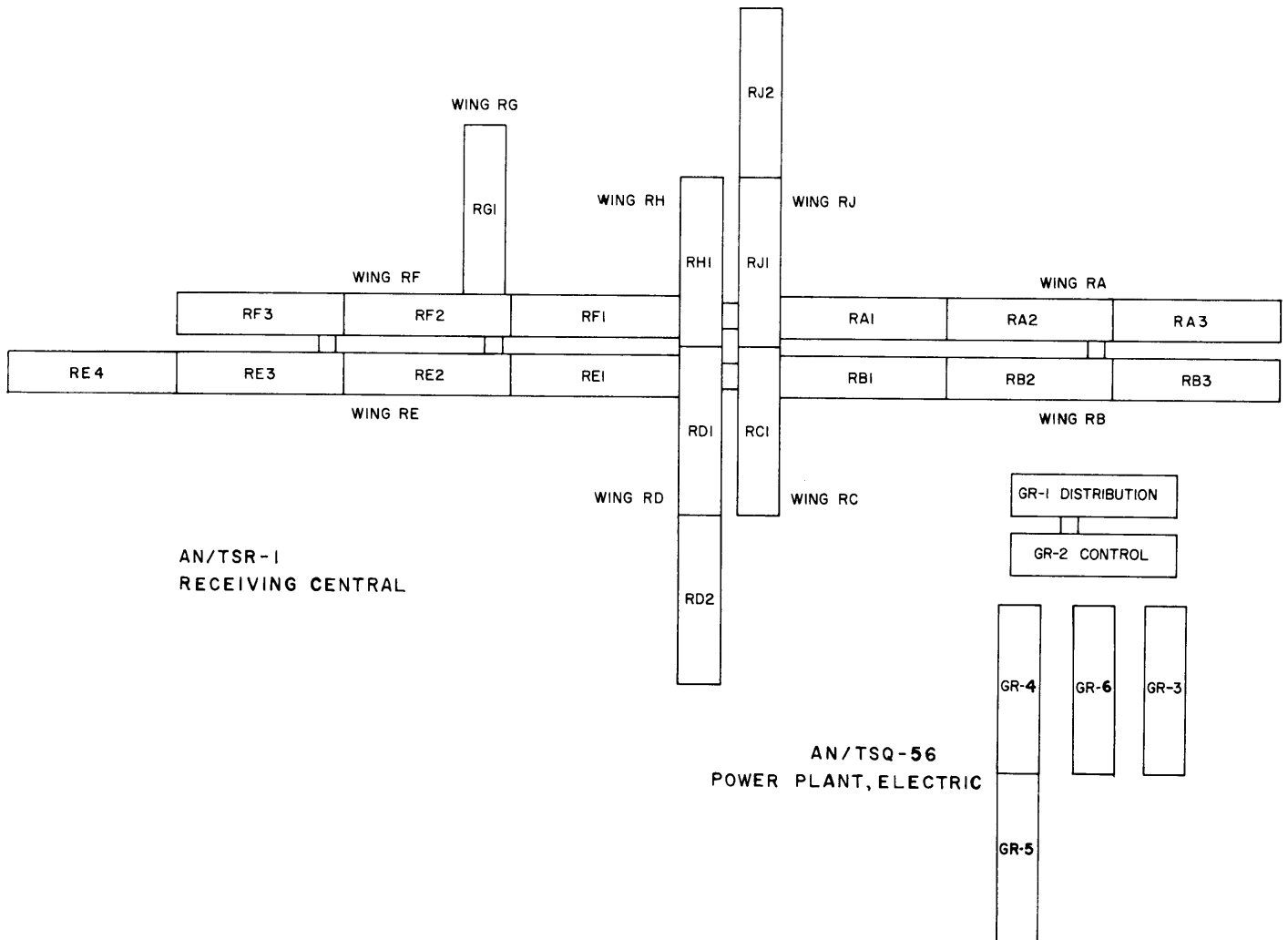

Figure 1-3. Site Plan, Receiving Central AN/TSR-1 Containers

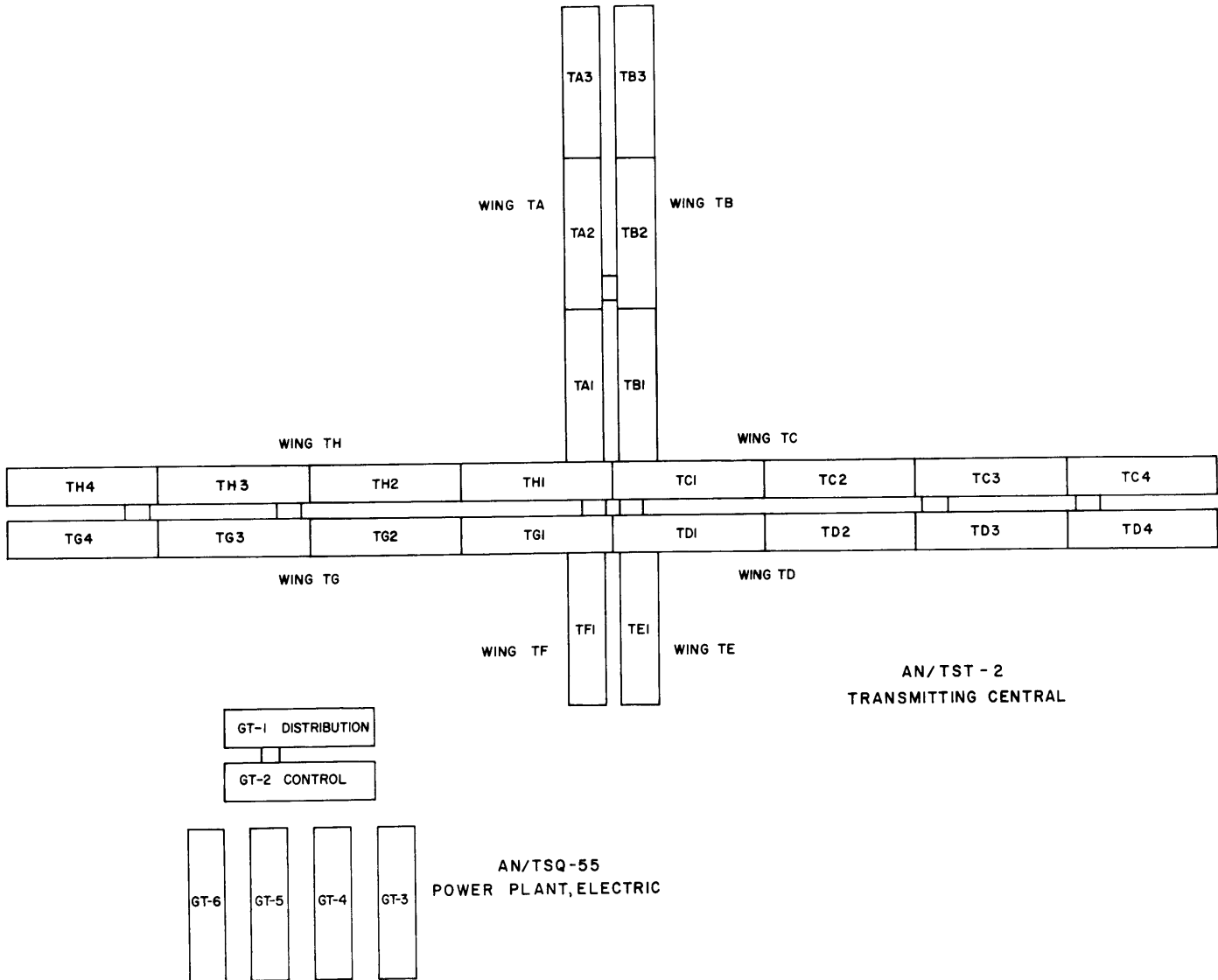

Figure 1-4. Site Plan, Transmitting Central AN/TST-2 Containers

fied according to their positions in their respective wings at each site, such as RA1 or TA1, the R for receiver site or T for transmitter site, the A for the wing location, and the 1 for the first container in the wing nearest the center of the group. The forward ends of the containers face the outside of the complex. The power generation and distribution containers at both sites are physically separated from the remainder of the complex as illustrated in figure 1-3 and 1-4. These containers are designated by first a letter G, followed by R for Receiving Central or T for Transmitting Central, and a numeral suffix such as 1 for Power Distribution, 2 for Power Control, and 3, 4, 5, or 6 for Generators. All AN/TSC-35 containers, with the exception of the power distribution, generator and helix containers, are equipped with all-weather air-conditioning units that mount on the outside walls.

1-22. COMMUNICATION SYSTEM AN/TSC-35 (SYM-2005-TR) MAJOR COMPONENTS.

Table 1-1 lists the name, manufacturers model number, and the military nomenclature of the AN/TSC-35 major components. The major components are the two sites, their containers and the mobile workshop trailer. The antennas installed at both sites are listed in table 1-3, and the operating equipment installed in the containers are listed in table 1-4.

1-23. DESCRIPTION OF RECEIVING CENTRAL AN/TSR-1 CONTAINERS.

The following paragraphs contain a brief description of the Receiving Central AN/TSR-1 (COMM-CENTER/Receiver Site) containers and their contents. A

TABLE 1-1. COMMUNICATION SYSTEM AN/TSC-35 (SYM-2005-TR) MAJOR COMPONENTS

NAME	TMC MODEL NUMBER	MILITARY NOMENCLATURE
Receiver Site	SYM-2005-R	RECEIVING CENTRAL AN/TSR-1
Container RA1 - HICOM/ASC	SYM-2005-RA1	RECEIVING CENTRAL GROUP OA-3887/TSR-1
Container RA2 - Off-Line and Crypto Repair	SYM-2005-RA2	RECEIVING CENTRAL GROUP OA-4936/TSR-1
Container RA3 - Special Receiver Container	SYM-2005-RA3	RECEIVING CENTRAL GROUP OA-7041/TSR-1
Container RB1 - Classified Control	SYM-2005-RB1	TELETYPE CENTRAL AN/TGC-16
Container RB2 - Crypto	SYM-2005-RB2	RECEIVING CENTRAL GROUP OA-4937/TSR-1
Container RB3 - Crypto	SYM-2005-RB3	RECEIVING CENTRAL GROUP OA-4938/TSR-1
Container RC1 - Multi-Channel Crypto	SYM-2005-RC1	RECEIVING CENTRAL GROUP OA-4939/TSR-1
Container RD1 - Electronic Repair	SYM-2005-RD1	MAINTENANCE EQUIPMENT GROUP OA-4941/TSR-1
Container RD2 - Supply	SYM-2005-RD2	SUPPLY CENTER OA-4942/TSR-1
Container RE1 - Unclassified Control	SYM-2005-RE1	TELETYPE CENTRAL AN/TGC-17
Container RE2 - HICOM Voice & Microwave	SYM-2005-RE2	RECEIVING CENTRAL GROUP OA-4943/TSR-1
Container RE3 - Receivers	SYM-2005-RE3	RECEIVING CENTRAL GROUP OA-4944/TSR-1
Container RE4 - Receivers and RF Patching	SYM-2005-RE4	RECEIVING CENTRAL AN/TSR-2
Container RF1 - Message Center	SYM-2005-RF1	RECEIVING CENTRAL GROUP OA-4945/TSR-1
Container RF2 - C/W Ship/Shore	SYM-2005-RF2	CONTROL-MONITOR GROUP OA-4950/TSR-1
Container RF3 - Air/Ground	SYM-2005-RF3	CONTROL-MONITOR GROUP OA-4951/TSR-1
Container RG1 - Communication Office	SYM-2005-RG1	RECEIVING CENTRAL GROUP OA-4966/TSR-1
Container RH1 - TTY Repair	SYM-2005-RH1	MAINTENANCE EQUIPMENT GROUP OA-4967/TSR-1
Container RJ1 - NTX Receive	SYM-2005-RJ1	TELETYPE CENTRAL AN/TGC-18
Container RJ2 - NTX Send	SYM-2005-RJ2	TELETYPE CENTRAL AN/TGC-19
Electric Power System	SYM-2005-GR	POWER PLANT, ELECTRIC AN/TSQ-56
Container GR1 - Power Distribution	SYM-2005-GR1	POWER DISTRIBUTION GROUP OA-4968/TSQ-56

TABLE 1-1. COMMUNICATION SYSTEM AN/TSC-35 (SYM-2005-TR) MAJOR COMPONENTS (CONT)

NAME	TMC MODEL NUMBER	MILITARY NOMENCLATURE
Container GR2 - Power Control	SYM-2005-GR2	POWER CONTROL GROUP OA-4969/TSQ-56
Containers GR3 and GR6-Generators	SYM-2005-GR3 & 6	GENERATOR SET, DIESEL ENGINE PU-600/TSQ
Container GR4 and GR5 - No Break Power	SYM-2005-GR4 & 5	GENERATOR SET, DIESEL ENGINE PU-612/TSQ
Transmitter Site	SYM-2005-T	TRANSMITTING CENTRAL AN/TST-2
Container TA1, TA2, TB2, TB3, TC4, TD4, and TG2 - Transmitter Set 10K	SYM-2005-TA1, TA2, TB2, TB3, TC4, TD4, & TG2	TRANSMITTING SET, RADIO AN/TRT-17
Container TA3 - Transmitter Set 1-K and 10-K	SYM-2005-TA3	TRANSMITTING SET, RADIO AN/TRT-23
Container TB1, TC2, TC3, TD2, TD3, TG3 & TH1 - Transmitter Set 40K	SYM-2005-TB1, TC2, TC3, TD2, TD3, TG3, & TH1	TRANSMITTING SET, RADIO AN/TRT-18
Container TC1 - Transmitter Control	SYM-2005-TC1	CONTROL-MONITOR GROUP OA-4915/TST-2
Container TD1 - RF Distribution	SYM-2005-TD1	INTERCONNECT GROUP OA-4916/TST-2
Container TE1 - Transmitter Set - Low Frequency	SYM-2005-TE1	TRANSMITTING SET, RADIO AN/TRT-19
Container TF1 - Work Shop	SYM-2005-TF1	MAINTENANCE EQUIPMENT GROUP OA-4917/TST-2
Container TG1 - RF Distribution	SYM-2005-TG1	INTERCONNECT GROUP OA-4918/TST-2
Container TH2 - Transmitter Set 40K	SYM-2005-TH2	TRANSMITTING SET, RADIO AN/TRT-20
Container TH3 - Transmitter Set 200K	SYM-2005-TH3	TRANSMITTING SET, RADIO AN/TRT-24
Containers TH4-Transmitter Set 50K and TG4-Low Pass Filter	SYM-2005-TH4 and SYM-2005-TG4	TRANSMITTING SET, RADIO, AN/TRT-25
Helix Container	SYM-2005-HELIX	ANTENNA COUPLER GROUP OA-4940/TST-2
Electric Power System	SYM-2005-GT	POWER PLANT, ELECTRIC AN/TSQ-55
Container GT1-Power Distribution	SYM-2005-GT1	POWER DISTRIBUTION GROUP OA-4921/TSQ-55
Container GT2-Power Control	SYM-2005-GT2	POWER CONTROL GROUP OA-4922/TSQ-55
Containers GT3, GT4, GT5 and GT6 - Generators	SYM-2005-GT3, 4, 5, & 6	GENERATOR SET, DIESEL ENGINE PU-600/TSQ
Mobile Workshop Trailer		



Figure 1-5. Receiving Central Group OA-3887/TSR-1 (RA1 Right Side Equipment)

detailed description of each container and its equipment is contained in Volume 2 of this manual.

1-24. RECEIVING CENTRAL GROUP OA-3887/TSR-1 (CONTAINER RA1).

Container RA1, figures 1-5 and 1-6, is the HICOM/ASC area of the Receiving Central. RA1 provides an 18-line HICOM/ASC torn-tape relay facility with twelve receive page-copy monitoring positions. Torn-tape relay equipment includes an AN/FGC-73 Multiple-Addressee Processing System comprised of a control console and eight TT-329 high-speed reperforators; an AN/FGC-59 Torn-Tape Relay Set consisting of three TT-331 Teletype Receive Groups, six TT-333 Teletype Transmitter Groups that are equipped for tandem operation, and three TT-332 Transmit Monitor Groups; an AN/UGC-6 for run-off; and an AN/UGC-6 for message correction. Monitor facilities include twelve receive TT-176A page-copy teletype units and an 18-line TTY monitor patch panel. Additional facilities provided in RA1 include a TT-47 internal order-wire machine, a RED INTERCOM unit, a supervisor's desk, a message make-up table, a storage cabinet for monitor reels and broadcast tapes, and two storage cabinets for paper supplies.

AN/TSC-35

1-25. RECEIVING CENTRAL GROUP OA-4936/TSR-1 (CONTAINER RA2).

Container RA2 provides the Off-Line operating and cryptographic repair facilities. The Off-Line area, figure 1-7, houses two AN/GGA-1 positions, two HW-19/10 positions, one AN/UGC-6 and two TT-171A teletype units for use with the HW-19/10 equipment, one AN/UGC-6 and one TT-171A for use on pony circuits, and a large floor-mounted safe for storage of classified material. The repair area, figure 1-8, is equipped with workbenches, a utility shelf, test equipment, test carts, tools, and cabinets for storing parts and equipment. Signal trunk lines are provided from the workbenches to the RED MDF. A RED voice-in-

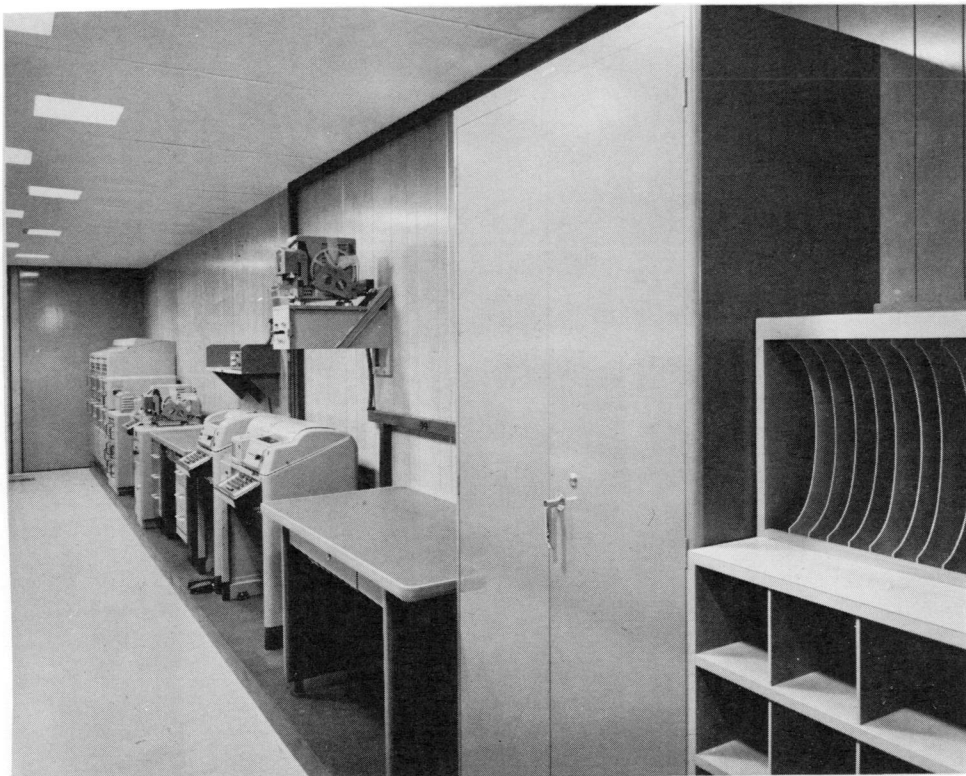

Figure 1-6. Receiving Central Group OA-3887/TSR-1 (RA1 Left Side Equipment)



Figure 1-7. Receiving Central Group OA-4936/TSR-1 (RA2, Off-Line Area)

tercommunication unit is installed on the utility shelf above the workbenches.

1-26. RECEIVING CENTRAL GROUP OA-7041/
TSR-1 (CONTAINER RA3).

Container RA3 (figures 1-9 and 1-10) is a special equipment container designed to provide in itself a complete communication facility dependent only upon a primary power source. Container RA3 can operate at

communication stations using 10-kc phase-shift signaling such as a Receiving Central AN/TSR-1, or at those stations using standard 20-ma or 60-ma DC signaling. RA3 is configured for both RED and BLACK circuitry and is equipped with completely separated RED and BLACK ferrous-shielded ducting, audio and DC patching and programming facilities, and RED and BLACK primary power distribution.

1-27. Equipment provided in container RA3 includes one RED and one BLACK signal control rack (each with



Figure 1-8. Receiving Central Group OA-4936/TSR-1 (RA2, Crypto Repair Area)



Figure 1-9. Receiving Central Group OA-7041/TSR-1 (RA3, Rear Area)

audio and DC capability), one KW-26C rack, two AN/UGC-6 send positions, two TT-171A receive positions, one TT-47 order-wire position, an RF distribution rack housing two SPP-40416 RF patch panels and three CU-656 multicouplers, twenty-one pieces of special test equipment, and provisions for mounting three special receiver racks and one special test rack. Additional facilities include a safe for storage of classified material, a file safe, two file cabinets, one desk, two equipment storage cabinets, three spare-parts storage racks, and one workbench. The container is equipped with a baffled entrance door at the rear and an emergency exit door at the front end.

1-28. TELETYPE CENTRAL AN/TGC-16 (CONTAINER RB1).

Container RB1 is the Classified Control area (see figure 1-11). RB1 contains the RED Main Distribution Frame (MDF) and associated patchboard, four KW-37 positions, six point-to-point order-wire TTY's, four

monitor TTY's, one station order-wire TTY, one KW-37 order-wire TTY, a AN/GGM-1 distortion measuring set, a "Fox" 20-channel distribution amplifier, a tone converter rack, a desk, a file safe, RED and BLACK INTERCOM units, and provisions for installing four KG-14 units.

1-29. RECEIVING CENTRAL GROUP OA-4937/TSR-1 (CONTAINER RB2).

Container RB2 is a part of the single-channel On-Line cryptographic area which consists of containers RB2 and RB3. Container RB2 (figures 1-12 and 1-13) houses twenty-eight KW-26 operating positions and associated order-wire equipment. Facilities provided in each operating position include a tone converter drawer, a card holder, and all hardware and wiring required for the installation of a send/receive KW-26 unit. Order-wire equipment includes eight full-duplex TT-176A teletype units and four control panels. Additional facilities provided in RB2 include a RED INTERCOM unit, a desk, a file safe, a file cabinet, and

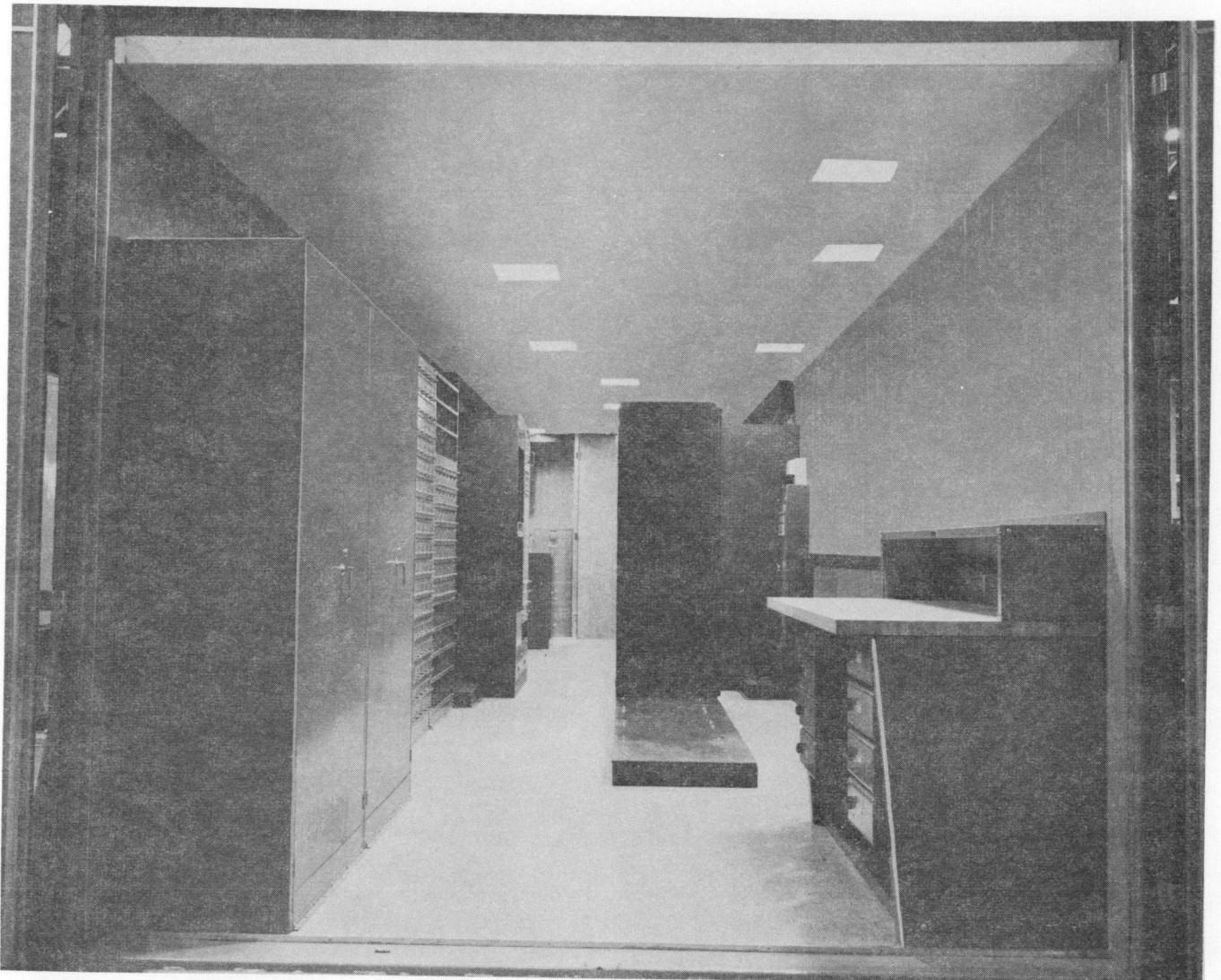

Figure 1-10. Receiving Central Group OA-7041/TSR-1 (RA3, Front Area)

one equipment rack for future installation of KW-7 units.

1-30. RECEIVING CENTRAL GROUP OA-4938/
TSR-1 (CONTAINER RB3).

Container RB3 (figures 1-14 and 1-15) houses thirty-five KW-26 operating positions, eight TT-176A order-wire teletype units and four order-wire control panels. The KW-26 operating positions are identical to those installed in RB2. A dual-readout digital clock is provided at the front end of the container.

1-31. RECEIVING CENTRAL GROUP OA-4939/
TSR-1 (CONTAINER RC1).

Container RC1 (figure 1-16) is the multi-channel On-Line area providing three 4-channel cryptographic operating positions. Each position is equipped with a

send/receive AN/UGC-1A multiplex terminal, tone converters, loop supplies, a TT-176A order-wire teletype unit, and all hardware and wiring required for the installation of a send/receive KW-22 unit. Additional facilities provided include a RED INTERCOM, dual-readout digital clock, a supervisor's desk and a file safe.

1-32. MAINTENANCE EQUIPMENT GROUP OA-
4941/TSR-1 (CONTAINER RD1).

Container RD1 (figure 1-17) is the electronic repair shop of the Receiving Central. Equipment installed in RD1 includes workbenches, parts storage bins, equipment storage cabinet, drill press, bench-mounted vise and grinder, and a BLACK INTERCOM. Three electronic repair tool kits, four mobile service carts and twenty-one types of electronic test equipment are provided in this container.



Figure 1-11. Teletype Central AN/TGC-16 (RB1, Equipment Installation)

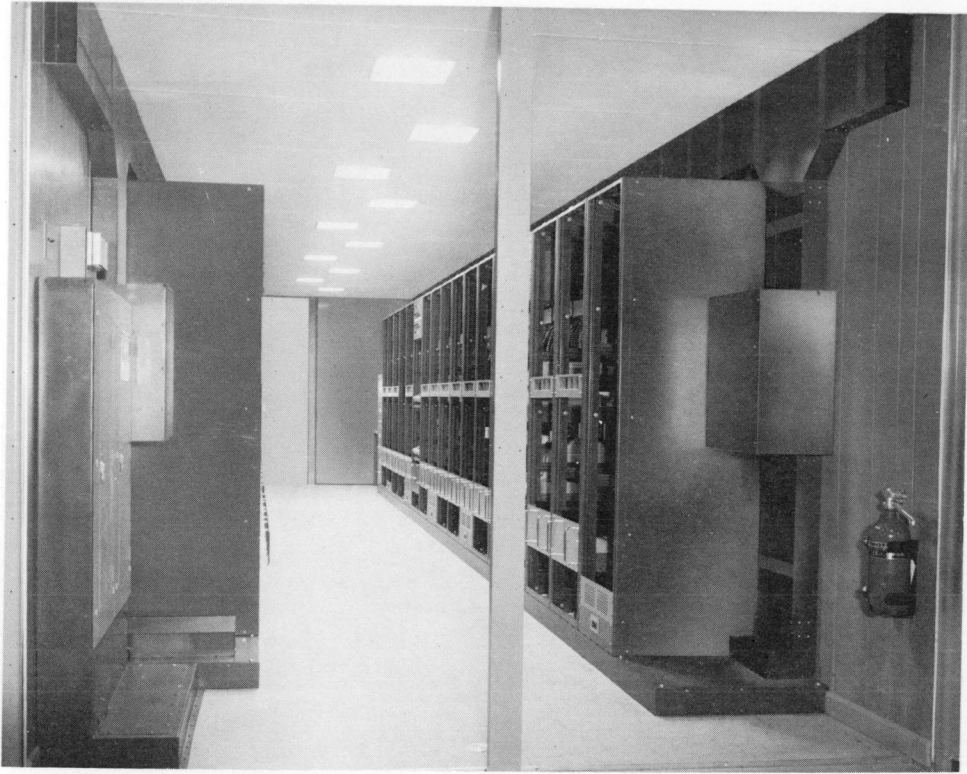

Figure 1-12. Receiving Central Group OA-4937/TSR-1 (RB2, Right Side Equipment)

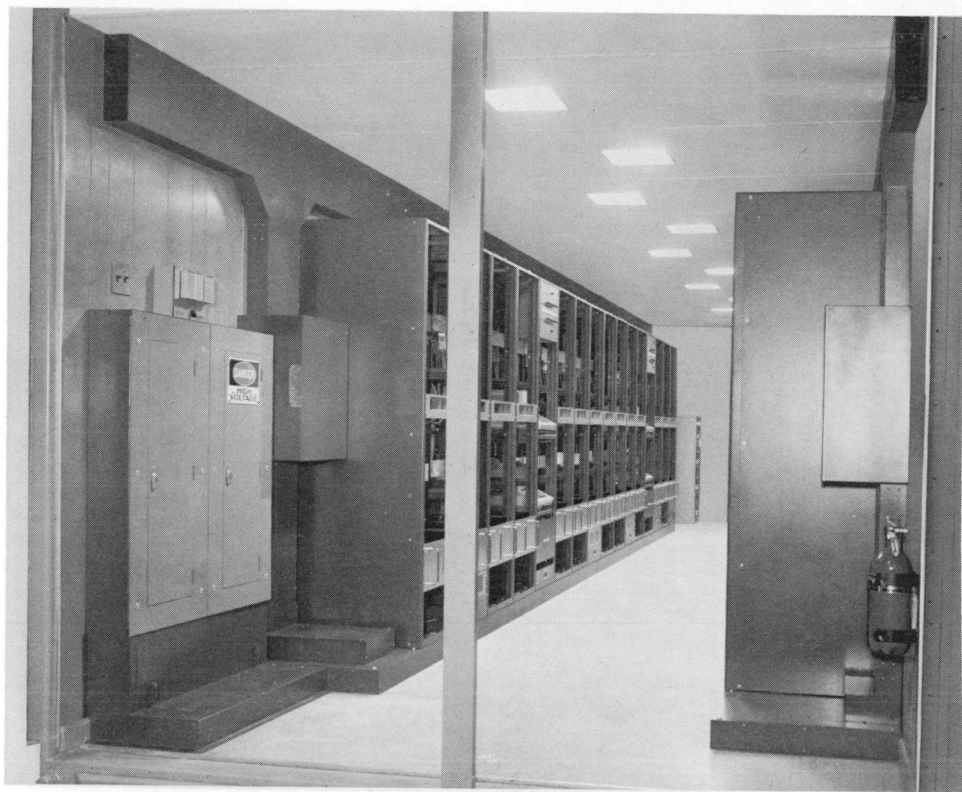

Figure 1-13. Receiving Central Group OA-4937/TSR-1 (RB2, Left Side Equipment)

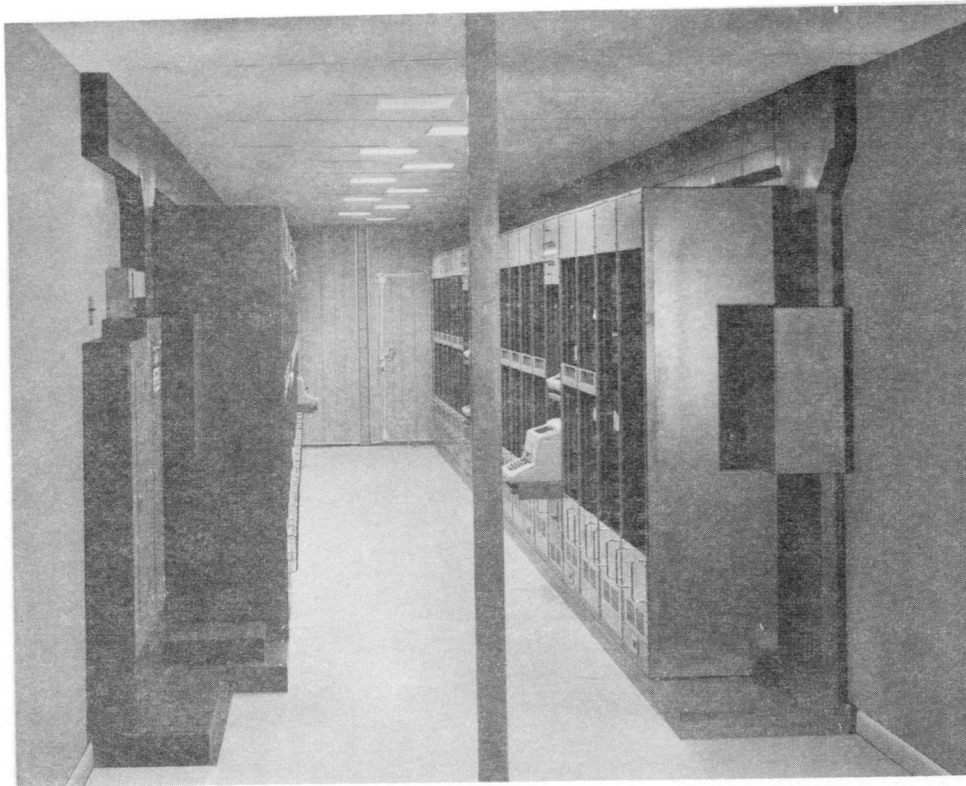

Figure 1-14. Receiving Central Group OA-4938/TSR-1 (RB3, Right Side Equipment)

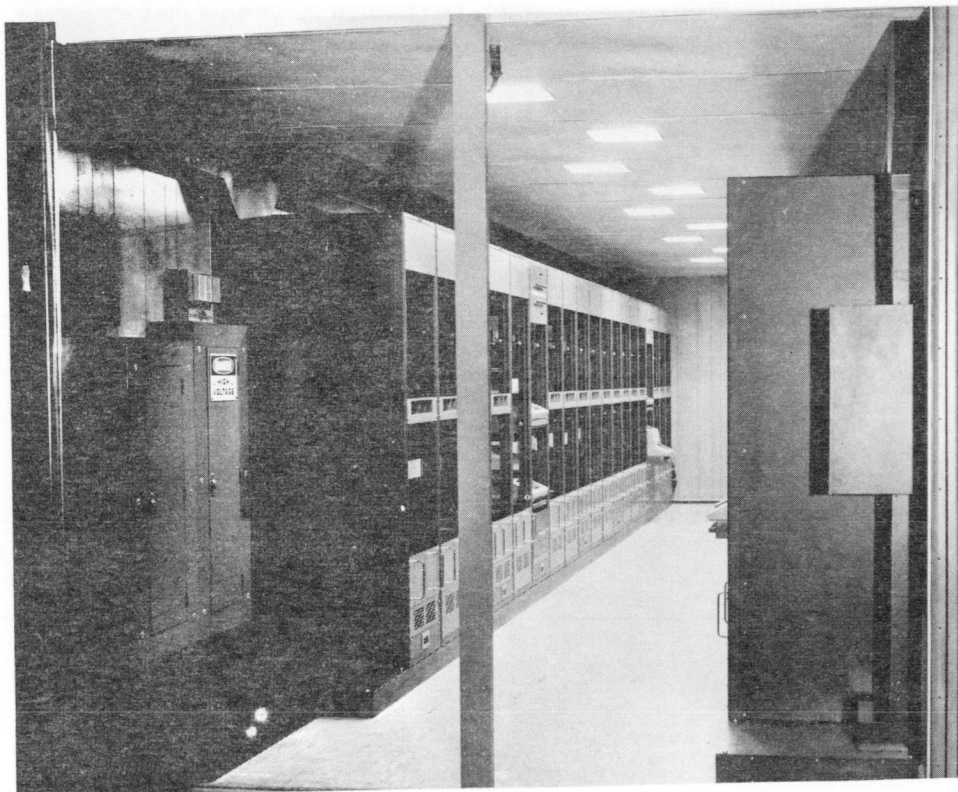

Figure 1-15. Receiving Central Group OA-4938/TSR-1 (RB3, Left Side Equipment)



Figure 1-16. Receiving Central Group OA-4939/TSR-1 (RC1, Equipment Installation)



Figure 1-17. Maintenance Equipment Group OA-4941/TSR-1 (RD1, Equipment Installation)

1-33. SUPPLY CENTER OA-4942/TSR-1 (CONTAINER RD2).

Container RD2 (figure 1-18) is the supply area of the Receiving Central. A Dutch door equipped with a shelf for issuing supplies is located in the rear wall and a door for loading supplies into RD2 is at the front of the container. Supply facilities provided in RD2 include storage bins along both sidewalls, shelf-storage units in the center, and a storekeeper's desk, a supply catalogue shelf and an electric clock in the rear area adjacent to the Dutch door.

1-34. TELETYPE CENTRAL AN/TGC-17 (CONTAINER RE1).

Container RE1 (figures 1-19 and 1-20) is the Unclassified Control area of the Receiving Central. RE1 houses the BLACK MDF and patchboard, eight 16-channel diversity full-duplex tone-telegraph terminals, four 16-channel non-diversity full-duplex tone telegraph terminals, three sets of 8-narrow and 4-wideband non-diversity tone telegraph terminals, six point-to-point duplex order-wire and one station order-wire TT-176A equipments, two TT-176A monitors, an AN/GGM-1 distortion measuring equipment, an audio spectrum analyzer, an audio oscillator, a 20-channel "Fox" distribution amplifier, a BLACK INTERCOM unit, a desk and a storage cabinet.

1-35. RECEIVING CENTRAL GROUP OA-4943/TSR-1 (CONTAINER RE2).

Container RE2 is the Voice and Microwave Operating area (see figure 1-21). The voice operating position contains two R-390A receivers, two CV-591A SSB converters, four BSP-2 speaker-amplifiers, five TA-401B voice terminals, transmitter and receiver control panels, two microphones, and headphones. The microwave terminal consists of 74B-1 transmitters and receivers and an AN/FCC-17 voice terminal having 48-send and 12-receive channels. The AN/FCC-17 is expandable to 60-send and 60-receive channels. Additional equipment includes AN/URR-27 and AN/URR-35 receivers, AN/GRT-3 and AN/URT-7 transmitters, an AN/SRC-20 UHF transceiver, a special distribution frame (SDF) with an associated patchboard, a 2067 two-tone telegraph keyer, SPU-2 speech processing units, a BLACK INTERCOM unit, and a dehydrator.

1-36. RECEIVING CENTRAL GROUP OA-4944/TSR-1 (CONTAINER RE3).

Container RE3, in conjunction with RE4, comprises the primary Receivers area of the Receiving Central. Container RE3 (see figures 1-22 and 1-23) houses six AN/FRR-60 dual-diversity synthesized SSB receivers, fifteen R-5007/FRR-502 monitor receivers, sixteen R-390A receivers, four R-389 receivers, twenty-eight frequency-shift converters, RLPA controls, a

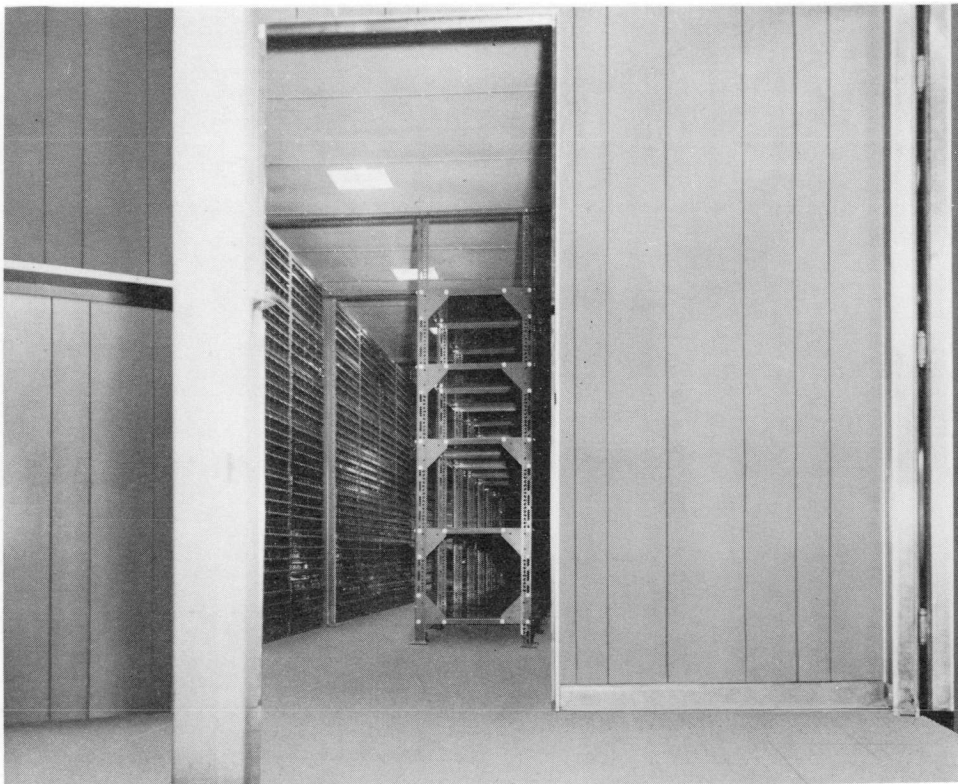

Figure 1-18. Supply Center OA-4942/TSR-1 (RD2, Rear Area)

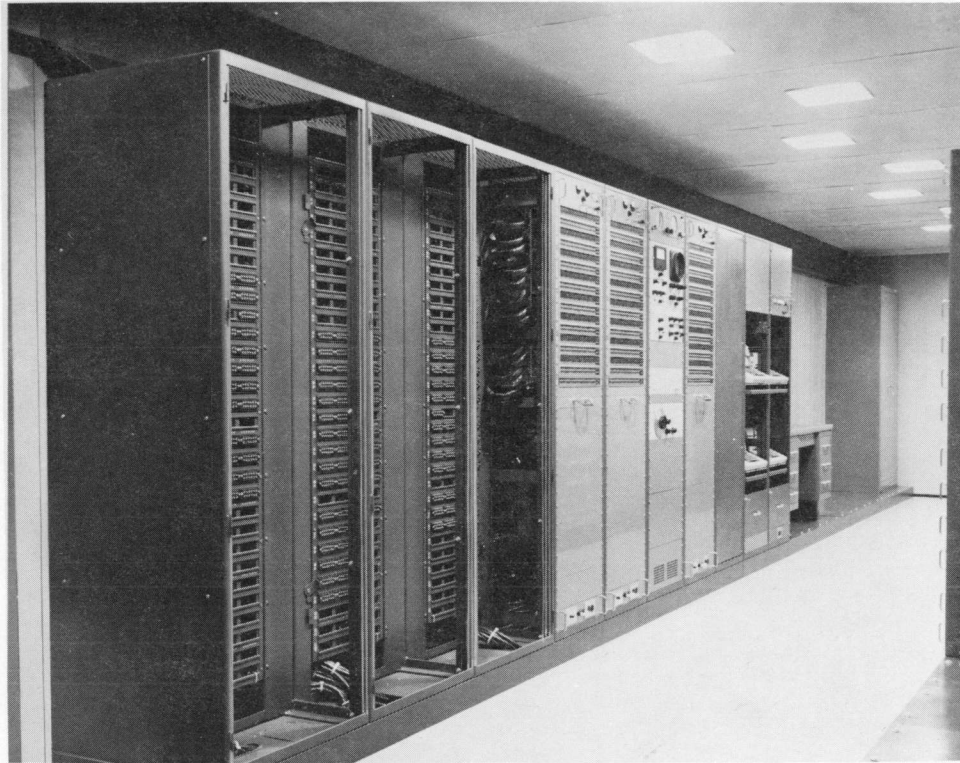

Figure 1-19. Teletype Central AN/TGC-17 (RE1, Left Side Equipment)



Figure 1-20. Teletype Central AN/TGC-17 (RE1, Right Side Equipment)

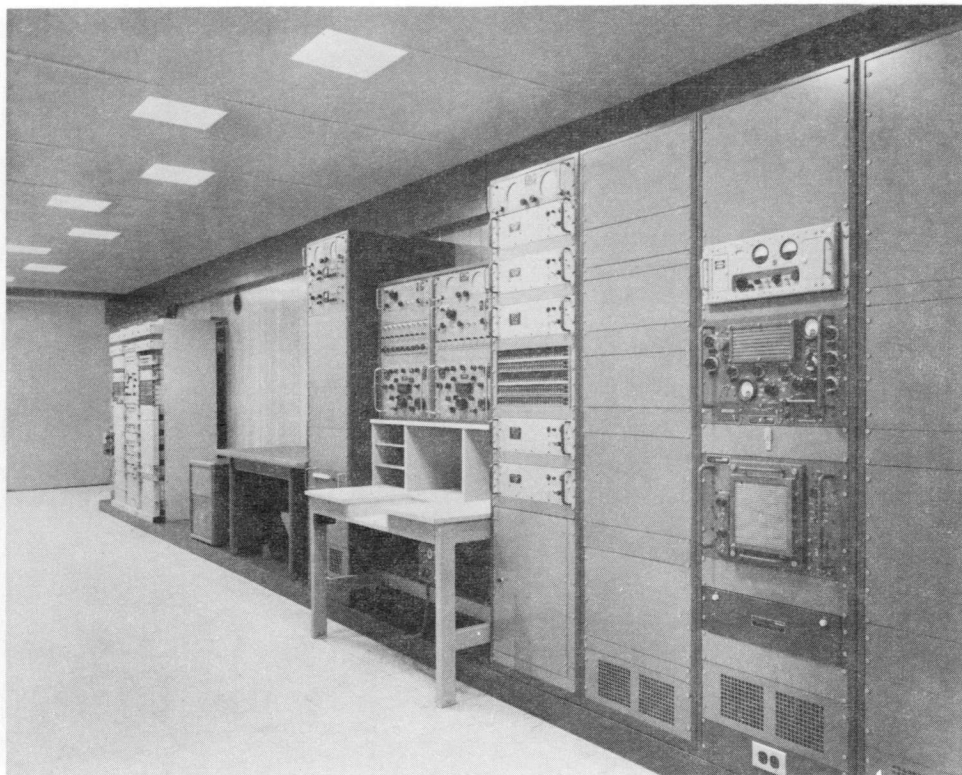

Figure 1-21. Receiving Central Group OA-4943/TSR-1 RE2, (Equipment Installation)

VLFC, the master station clock, two TT-176A TTY's, sixteen TD-411/UGC demultiplexers, a receivers intermediate distribution frame (IDF), a BLACK INTERCOM unit, and a desk.

1-37. RECEIVING CENTRAL GROUP AN/TSR-2 (CONTAINER RE4).

Container RE4 is adjacent to RE3 and is part of the primary receivers area. Equipment installed in RE4 (figures 1-24 and 1-25) includes three AN/FRR-60 dual-diversity synthesized SSB receivers, one AN/FRR-60 non-diversity SSB receiver, an 80-line antenna patching facility, fifteen CU-656 multicouplers with mounting provisions and wiring for twenty-one additional units, one LFD-1 low-frequency RF distribution unit, and facsimile equipment including a TT-321 transceiver, an AN/UXH-2 continuous page recorder, an MD-168 modulator, a CV-1066 converter, and an R-390A receiver.

1-38. RECEIVING CENTRAL GROUP OA-4945/TSR-1 (CONTAINER RF1).

Container RF1 is the message center of the Receiving Central (see figures 1-26 and 1-27). Teletype equipment installed in RF1 includes two AN/UGC-5 units for NTX and Pony send circuits, two AN/UGC-6 units for Run-Off and Make-Up positions, six TT-176A monitors, one TT-47 for internal order-wire, and a 3-line AN/FGC-59 torn-tape relay facility consisting of one each TT-331 receive group, TT-333 transmitter group, and TT-332 transmit monitor group. This

TT-333 transmitter group is not equipped for tandem operation. Desks are provided for the CWO, supervisor, traffic checker, and two routing positions. RED INTERCOM units are shelf-mounted above the CWO's desk and above the supervisor's desk. Storage facilities for monitor reels, tapes, and paper supplies are provided in two cabinets.

1-39. CONTROL MONITOR GROUP OA-4950/TSR-1 (CONTAINER RF2).

Container RF2 (figures 1-28 and 1-29) is the CW Ship/Shore operating area of the Receiving Central. RF2 contains three CW operating positions, two equipped with two R-390A receivers, and one with two R390A receivers and one R389 receiver. Each position also contains dual speaker-amplifiers, hand keys, a transmitter control panel, and a receiver control panel. Teletype equipment provided in RF2 includes four AN/UGC-8 weather positions, one AN/UGC-6 and one TT-47 for pony circuits, two AN/UGC-6 and two model 660A electronic TTY-to-morse code converters for CW/RATT broadcast operations, one TT-176A off-air monitor, and a TT-47 internal order-wire unit. Furniture includes a desk, a filing cabinet and a pigeon-hole tape-storage cabinet. A BLACK INTERCOM unit is mounted above the desk.

1-40. CONTROL MONITOR GROUP OA-4951/TSR-1 (CONTAINER RF3).

Container RF3 (figure 1-30) is the Air/Ground operations area of the Receiving Central and provides

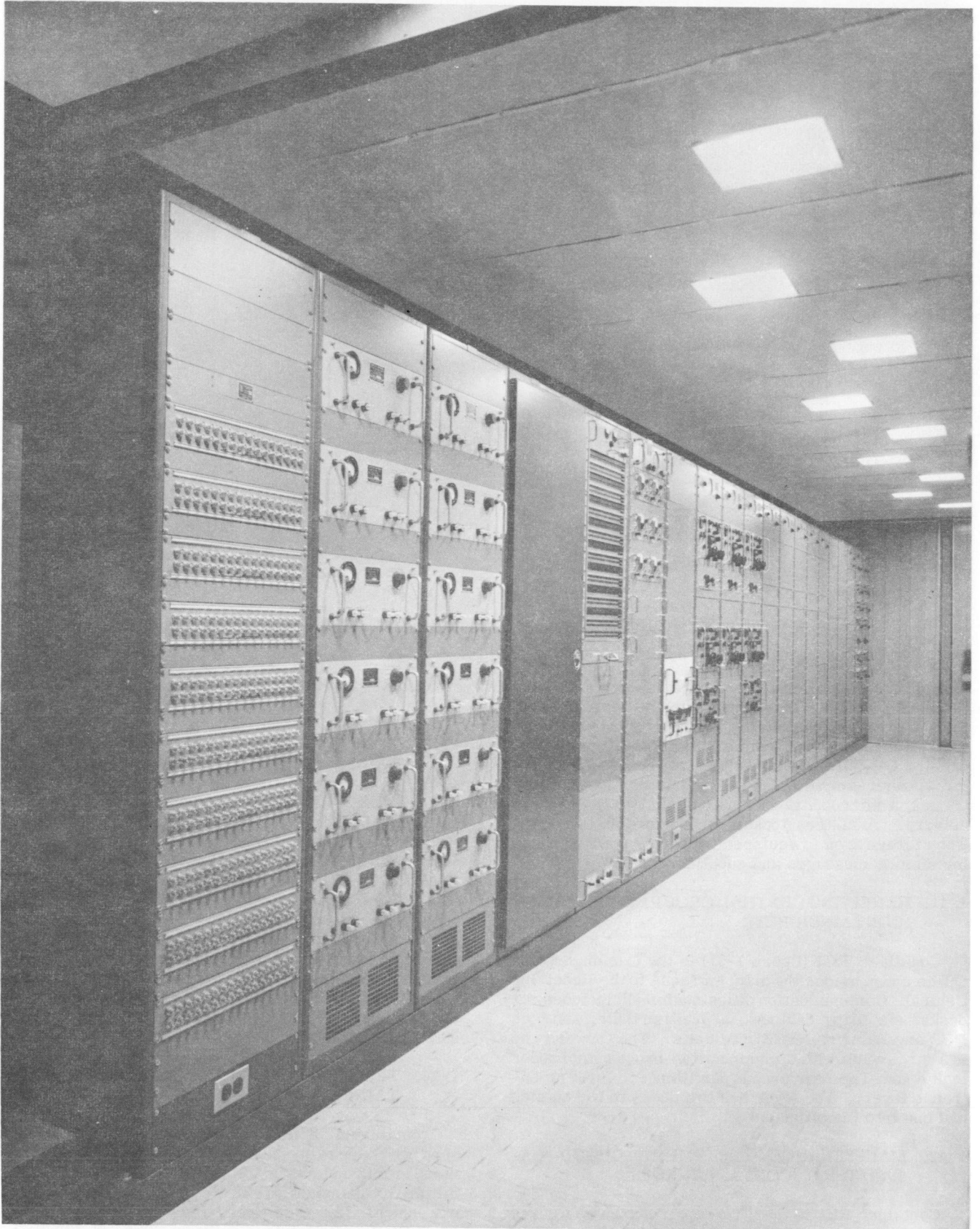

Figure 1-22. Receiving Central Group OA-4944 TSR-1, (RE3, Left Side Equipment)



Figure 1-23. Receiving Central Group OA-4944/TSR-1, (RE3, Right Side Equipment)

storage for message files and paper supplies. A partition divides the operations from the storage area. The operations area contains three operating positions, each equipped with a transmitter and a receiver control panel, a CV-591A SSB converter, two dual and one single speaker-amplifier units, a hand-key, two microphones, a microphone footswitch, and two R-390A receivers. A clothes locker is provided in this area. The storage area is equipped with three rows of racks for storing messages and supplies.

1-41. RECEIVING CENTRAL GROUP OA-4966/TSR-1 (CONTAINER RG1).

Container RG1 (figure 1-31) is the Communication Office and provides the main entrance to the Receiving Central. Communication office equipment includes six desks, six filing cabinets, a drafting table, and both RED and BLACK INTERCOM units. The forward end is a large vault with a manipulation-proof combination lock door. The rear area is partitioned to form an entrance foyer. The foyer has two doors to the outside and one into the office area.

1-42. MAINTENANCE EQUIPMENT GROUP OA-4967/TSR-1 (CONTAINER RH1).

Container RH1 is the TTY repair shop (see figures 1-32 and 1-33). RH1 contains workbenches, tools, parts storage racks, TTY test equipment, a BLACK INTERCOM unit, a desk, an air compressor, a sonic

cleaner, a spray rinse, a hot-air dryer and a hot water heater.

1-43. TELETYPE CENTRAL AN/TGC-18 (CONTAINER RJ1).

Containers RJ1 and RJ2 comprise the NTX torn-tape relay facility of the Receiving Central. Container RJ1 (figures 1-34 and 1-35) houses a 48-line NTX receive torn-tape relay facility. Teletype equipment provided in RJ1 includes eight TT-331 Teletype Receive Groups, nineteen TT-i76A page copy monitors, a monitor patch panel, an AN/FGC-73 routing console, a TT-329 high speed reperforator for NTX overflow, an AN/UGC-6 for correcting tapes, and a TT-176A station internal order-wire unit. Furniture provided in RJ1 includes two monitor reel storage cabinets, a supervisor's desk, and two filing cabinets. A RED INTERCOM unit is shelf-mounted above the desk.

1-44. TELETYPE CENTRAL AN/TGC-19 (CONTAINER RJ2).

Container RJ2 (figure 1-36) houses a 48-line NTX send torn-tape relay facility. Teletype equipment provided in RJ2 includes sixteen TT-333 Teletype Transmitter Groups, eight TT-332 Transmit Monitor Groups, sixteen TT-329 High-Speed Reperforators, and two AN/UGC-6 units for tape makeup. The TT-333 Teletype Transmitter Groups are equipped for tandem operation. The TT-329 High-Speed Reperforators are



Figure 1-24. Receiving Central Group AN/TSR-2 (RE4, Front Area)

fed NTX messages by the AN/FGC-73 routing console which is located in container RJ1.

1-45. POWER DISTRIBUTION GROUP OA-4968/TSQ-56 (CONTAINER GR1).

Container GR1 is the AC Power Distribution center of the Receiving Central. GR1 houses a standard power bus, a No-Break power bus, and circuit breakers for the distribution of primary AC power to all containers and rotatable log-periodic antennas at the Receiving Central.

NOTE

The Power System containers are illustrated in two power system manuals furnished with the Communication System. (Refer to paragraph 1-114.)

1-46. POWER CONTROL GROUP OA-4969/TSQ-56 (CONTAINER GR2).

Container GR2 is the AC Power Control center of the Receiving Central. GR2 houses a power control console and twelve 1600-ampere, 3-phase circuit breakers. The circuit breakers and the diesel engines and generators of the Receiving Central power plant are controlled electrically from the power control console.

1-47. GENERATOR SET, DIESEL ENGINE PU-600/TSQ (CONTAINERS GR3 AND GR6).

Containers GR3 and GR6 are Generator containers. Each generator container houses three diesel-driven 335-kilowatt, 208 volt, 60-cycle, 3-phase generators.

1-48. GENERATOR SET, DIESEL ENGINE PU-612/TSQ (CONTAINERS GR 4 AND GR5, "NO-BREAK" POWER).

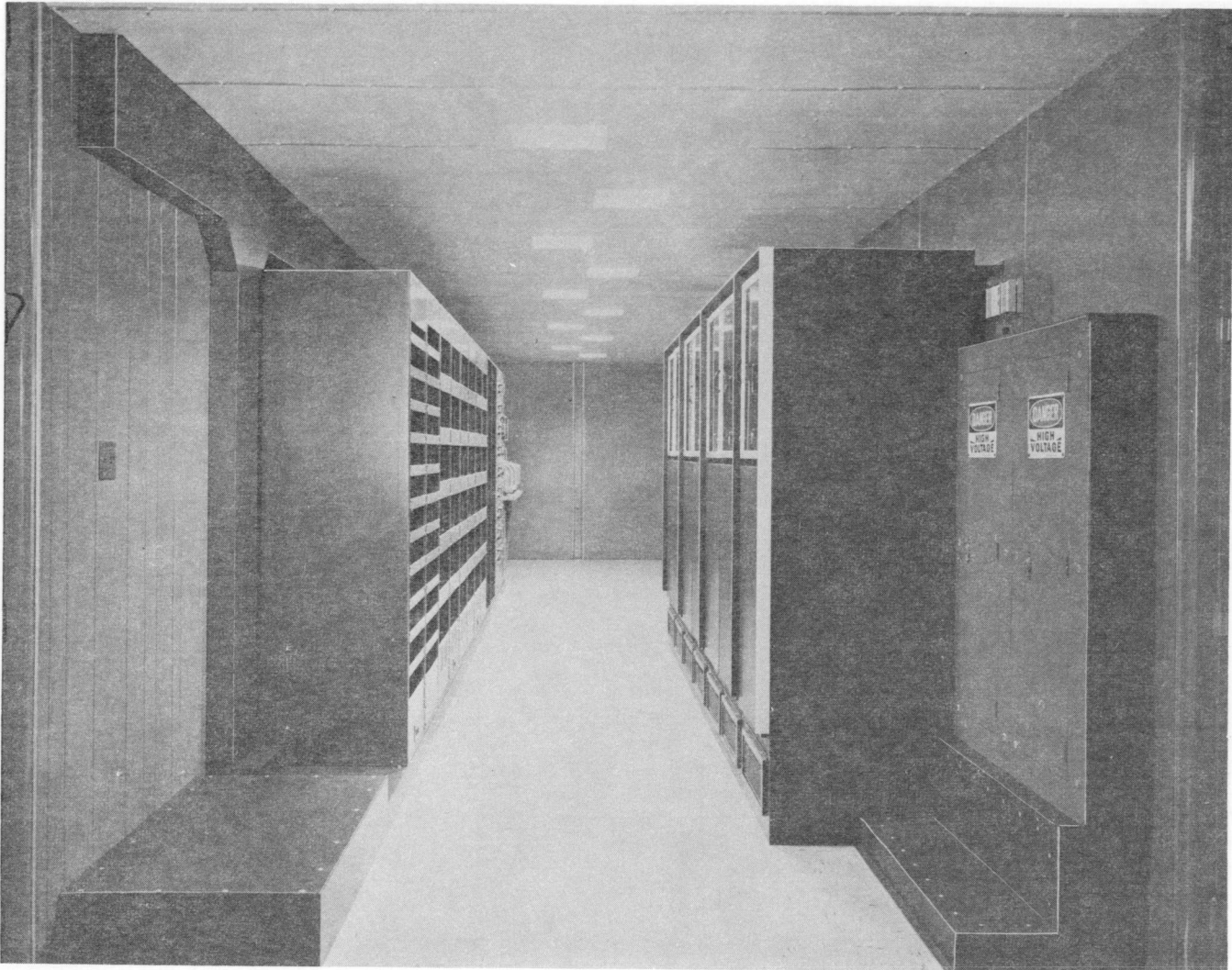

Figure 1-25. Receiving Central Group AN/TSR-2 (RE4, Rear Area)

Containers GR4 and GR5 each houses an FU-593/G 200-kilowatt No-Break primary power system that furnishes highly regulated 208-volt, 60-cycle 3-phase power.

1-49. DESCRIPTION OF TRANSMITTING CENTRAL AN/TST-2 CONTAINERS.

A brief description of the Transmitting Central (transmitting site) containers is given in the following paragraphs. For a detailed description of each container and its contents refer to Volume 3 of this manual.

1-50. RADIO TRANSMITTING SET AN/TRT-17 (CONTAINERS TA1, TA2, TB2, TB3, TC4, TD4 AND TG2).

Each AN/TRT-17 container (figures 1-37 and 1-38) houses five AN/FRT-39D synthesized 10-kilowatt (PEP) SSB transmitters. Each transmitter has provisions for both balanced and unbalanced RF output.

1-51. RADIO TRANSMITTING SET AN/TRT-23 (CONTAINER TA3).

Container TA3 (figures 1-39 and 1-40) houses two AN/FRT-39D synthesized 10-kilowatt (PEP) SSB transmitters and ten AN/URT-19(V) synthesized 1-kilowatt (PEP) SSB transmitters. Five of the AN/URT-19(V) transmitters are equipped for unbalanced RF output and the remaining transmitters in TA3 have facilities for both balanced and unbalanced output.

1-52. RADIO TRANSMITTING SET AN/TRT-18 (CONTAINERS TB1, TC2, TC3, TD2, TD3, TG3, AND TH1).

Each AN/TRT-18 container (figures 1-41 and 1-42) houses two AN/FRT-40B synthesized 40-kilowatt (PEP) SSB transmitters. Balanced and unbalanced RF output facilities are provided for each transmitter.



Figure 1-26. Receiving Central Group OA-4945/TSR-1 (RF1, Left Side Equipment)

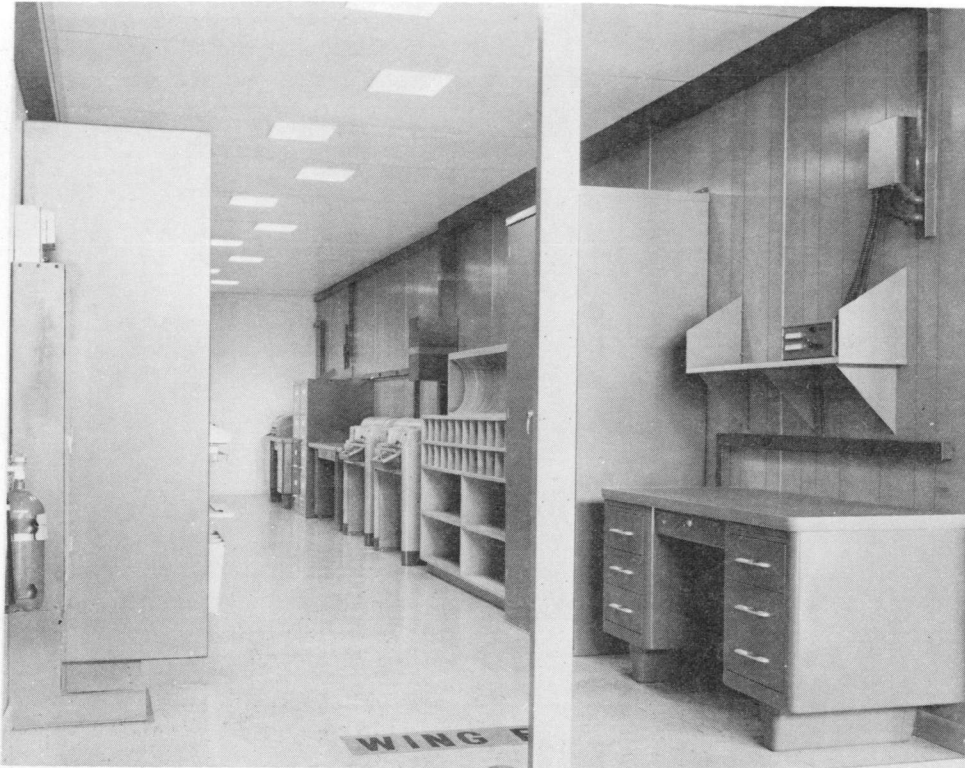

Figure 1-27. Receiving Central Group OA-4945/TSR-1 (RF1, Right Side Equipment)



Figure 1-28. Control Monitor Group OA-4950/TSR-1 (RF2, Left Side Equipment)



Figure 1-29. Control Monitor Group OA-4950/TSR-1 (RF2, Right Side Equipment)

1-53. CONTROL MONITOR GROUP OA-4915/TST-2 (CONTAINER TC1).

Container TC1 (figure 1-43) is the Transmitter Control area. Container TC1 houses the transmitter site audio and DC Main Distribution Frames, 74B-1 microwave transmitters and receivers, and AN/FGC-17 voice terminal having 24 send and 60 receive channels, RLPA controls, a VLFC, five transmitter alarm panels, five RF monitor patch panels, sixteen TD-410/UGC multiplexers, a 12-channel full-duplex and a 24-channel receive AN/FGC-60(V) telegraph terminals, sixty-four TH-39A/UGT tone intelligence units, AN/GRT-3 and AN/URR-35C UHF equipments, an R390A receiver, a TT-176A internal order-wire unit, a TT-176A teletype monitor unit, a voice INTERCOM unit, and a desk.

1-54. INTERCONNECT GROUP OA-4916/TST-2 (CONTAINER TD1).

Container TD1 houses four 50-ohm, 10 X 10 antenna patch panels, a 25-kilowatt (average power) dummy load, a 1 X 4 dummy-load patch panel, and a dehydrator unit. Inter-panel RF trunks are provided between the antenna patch panels and from the dummy load patch panel to each antenna patch panel. Figure 1-44 shows container TD1 partially equipped.

1-55. INTERCONNECT GROUP OA-4918/TST-2 (CONTAINER TG1).

Container TG1 houses identical equipment and facilities and is a mirror image of container TD1. TD1 and TG1 are joined together at the site to form one

AN/TSC-35

large RF distribution area. Figure 1-45 shows container TG1 partially equipped.

1-56. RADIO TRANSMITTING SET AN/TRT-19 (CONTAINER TE1).

Container TE1 (figure 1-46) houses an AN/FRT-19 low-frequency 15-kilowatt transmitter and two TAB-7 low-frequency 2-kilowatt transmitters. The container is equipped for balanced RF output from the AN/FRT-19 and for single-ended RF output from the TAB-7 transmitters.

1-57. MAINTENANCE EQUIPMENT GROUP OA-4917/TST-2 (CONTAINER TF1).

Container TF1 (figure 1-47) is one-half workshop and one-half supply area. The workshop is equipped with workbenches, test equipment, parts storage cabinets, a drill press, a bench vise, a bench grinder, and hand tools. The supply area contains one row of storage bins and two rows of storage shelves.

1-58. RADIO TRANSMITTING SET AN/TRT-20 (CONTAINER TH2).

Container TH2 houses two AN/FRT-40B synthesized 40-kilowatt (PEP) SSB transmitters and is similar to the AN/TRT-18 containers. One transmitter (see figure 1-48) was provided at the initial installation and a second AN/FRT-40B was added at a later date.



Figure 1-30. Control Monitor Group OA-4951/TSR-1 (RF3, Operations Area)



Figure 1-31. Receiving Central Group OA-4966/TSR-1 (RG1, Equipment Installation)

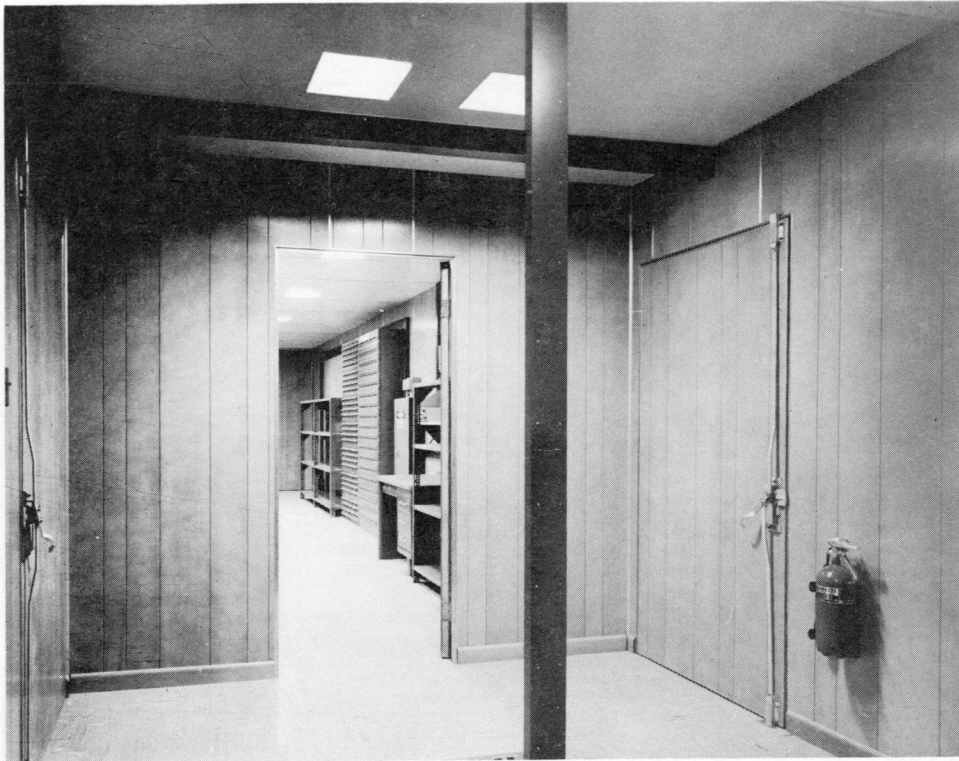

Figure 1-32. Maintenance Equipment Group OA-4967/TSR-1 (RH1, Right Side Equipment)

1-59. RADIO TRANSMITTING SET AN/TRT-24 (CONTAINER TH3).

Container TH3 (figures 1-49 and 1-50) houses all the components of an AN/FRT-62 synthesized 200-kilowatt (PEP) SSB transmitter which has provisions for both balanced and unbalanced RF output.

1-60. RADIO TRANSMITTING SET AN/TRT-25 (CONTAINERS TH4 AND TG4).

Container TH4 (figures 1-51 and 1-52) houses all the components of an AN/FRT-61 low-frequency 50-kilowatt transmitter except the harmonic filter and blower units which are located in container TG4.

1-61. Container TG4 (figures 1-53 and 1-54) houses Low-Pass Filter F-720/FRT-61 and Centrifugal Fan Assembly HD-554/FRT-61 which are units of the AN/FRT-61 transmitter housed in container TH4. The TG4 equipments are remotely controlled from container TH4.

1-62. ANTENNA COUPLER GROUP OA-4940/TST-2 (HELIX CONTAINER).

The helix container (figures 1-55 and 1-56) houses the antenna matching network that couples a 630-foot transmitting tower with the AN/FRT-19 transmitter in TE1. The floors, walls and ceiling of the equipment area (figure 1-56) are lined with aluminum sheets that are welded together to form a complete RF shield.

1-63. POWER DISTRIBUTION GROUP OA-4921/TSQ-55 (CONTAINER GT1).

Container GT1 is the AC Power Distribution center of the Transmitting Central. GT1 houses a main power bus and circuit breakers which are used to distribute primary AC power to all containers and antenna field equipment at the transmitter site.

1-64. POWER CONTROL GROUP OA-4922/TSQ-55 (CONTAINER GT2).

Container GT2 is the AC Power Control center of the Transmitting Central. GT2 provides control of diesel engines, generators, and the distribution of power from a control console. Twelve 1600-ampere electrically operated circuit breakers are installed in this container. Container GT2 is equipped with one air-conditioner unit. A voice INTERCOM unit, connected with a similar unit in container TC1, is installed in the control console.

1-65. GENERATOR SET, DIESEL ENGINE PU-600/TSQ (CONTAINERS GT3, GT4, GT5 AND GT6).

Each generator container houses three diesel-driven 335-kilowatt, 208-volt, 60-cycle, 3-phase generators.

1-66. MOBILE WORKSHOP TRAILER.

The mobile workshop trailer is primarily a diesel engine repair shop and differs from the basic AN/TSC-35 container in that it is a conventional trailer equipped



Figure 1-33. Maintenance Equipment Group OA-4967/TSR-1 (RH1, Left Side Equipment)

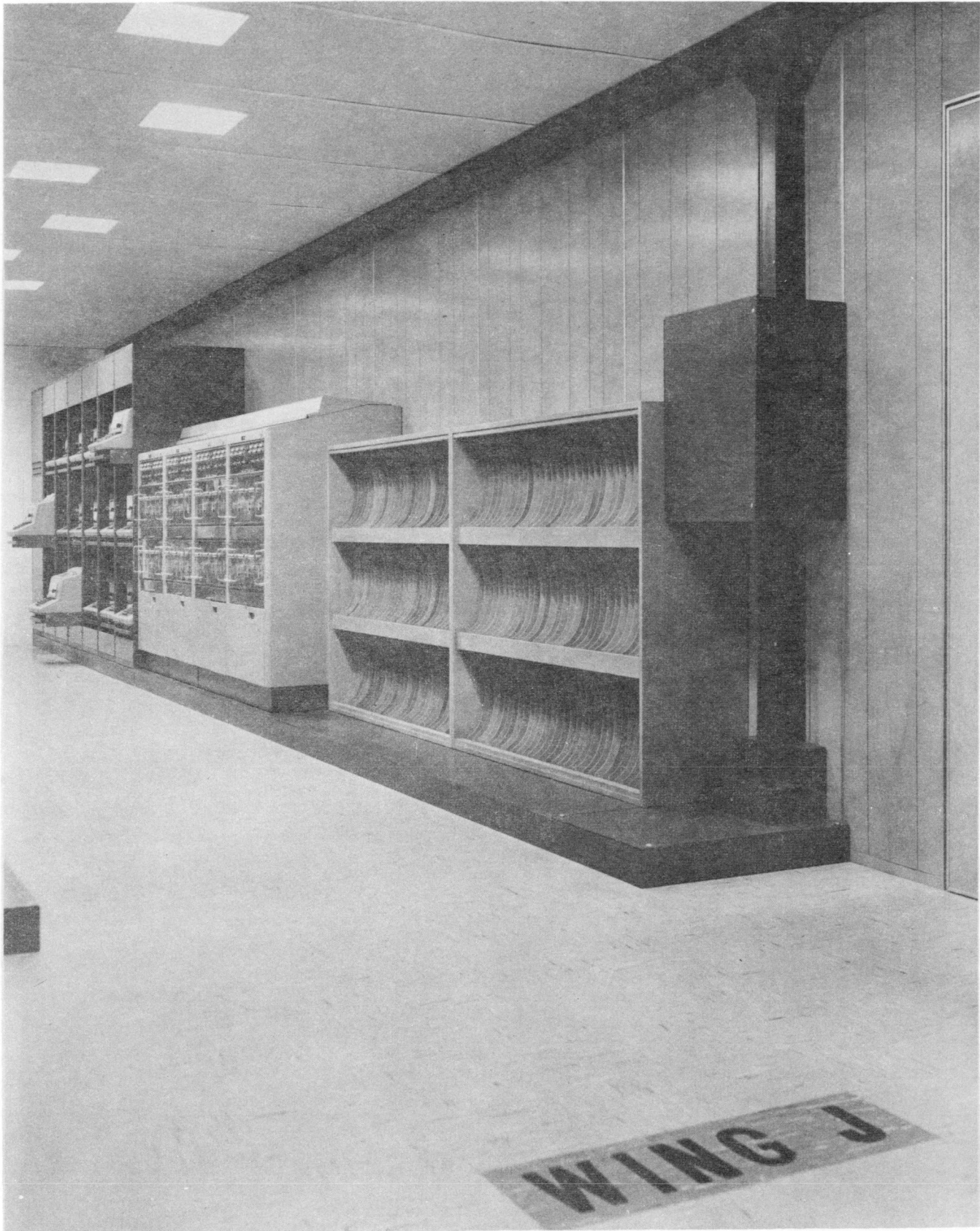

Figure 1-34. Teletype Central AN/TGC-18 (RJ1, Right Side Equipment)



Figure 1-35. Teletype Central AN/TGC-18 (RJ1, Left Side Equipment)



Figure 1-36. Teletype Central AN/TGC-19 (RJ2, Equipment Installation)

with a rear wheel assembly and front support, is narrower, and can be moved from site to site by a tractor as the need arises. The trailer is 40 feet long, 8 feet wide, and 9 feet 6 inches high. Double doors are installed at the rear and a personnel door is provided in the middle of the roadside wall. (See figure 1-61). One air conditioner unit is installed on the forward outside wall. The workshop trailer houses a valve grinder, a heavy-duty drill press, an air compressor, an agitator type parts cleaner, two workbenches, a tool chest containing hand tools, a parts storage cabinet, and a power distribution circuit-breaker panel. Power is furnished from a power distribution container at either site through a 100-foot 4-wire extension power cable.

1-67. TYPICAL CONSTRUCTION AN/TSC-35 CONTAINERS.

One basic shell type is used for all AN/TSC-35 containers. The basic container shell is modified to provide three types of containers that differ mainly in the placement of openings required for mating one container to another. Type 1 has open ends with two side doors near the rear; type 2 has open ends and no side doors; type 3 has open ends with two side doors near the front. Type 1 and 3 containers can be mated end-to-end or side-to-side while type 2 containers can be mated end-to-end only. The four center containers in each complex and RF2 (see figures 1-3 and 1-4) are type 1 containers that are also equipped for side-to-end connection. RA2 and RB3 are type 3 containers. The side doors provide entrance to the containers from the

outside or from enclosed side-to-side walkways which are installed at the locations indicated in the above figures. Personnel steps are provided at all outside entrance doors. Additional modifications of basic container shells are incorporated in the power containers to meet requirements for adequate ventilation and structural support as described in paragraph 1-77, and in the Helix container to meet RF shielding requirements as noted in paragraph 1-62.

1-68. CONTAINER EXTERIOR.

All AN/TSC-35 containers have the same outside dimensions. Each container is 40 feet long, 10 feet wide, and 9 1/2 feet high.

1-69. FLOOR, WALLS, AND ROOF. The floor, walls, and roof are made of structural steel members covered with an exterior skin of aluminum and an interior lining of plywood. Fiberglass insulation is packed into the spaces between the aluminum outer skin and the plywood lining of the walls and roof. (See figure 1-57). All areas under the container floor are undercoated. The container end-frames are one-piece welded steel units for rigidity. Removable end-frame units are furnished for connecting the end of one container to the side of another.

1-70. LIFTING, LOCKING AND ALIGNING PINS. Four side pins, one at each bottom corner (see figure 1-57), are used for lifting a container and for locking two containers together as illustrated. The generator containers, because of the added weight involved, are

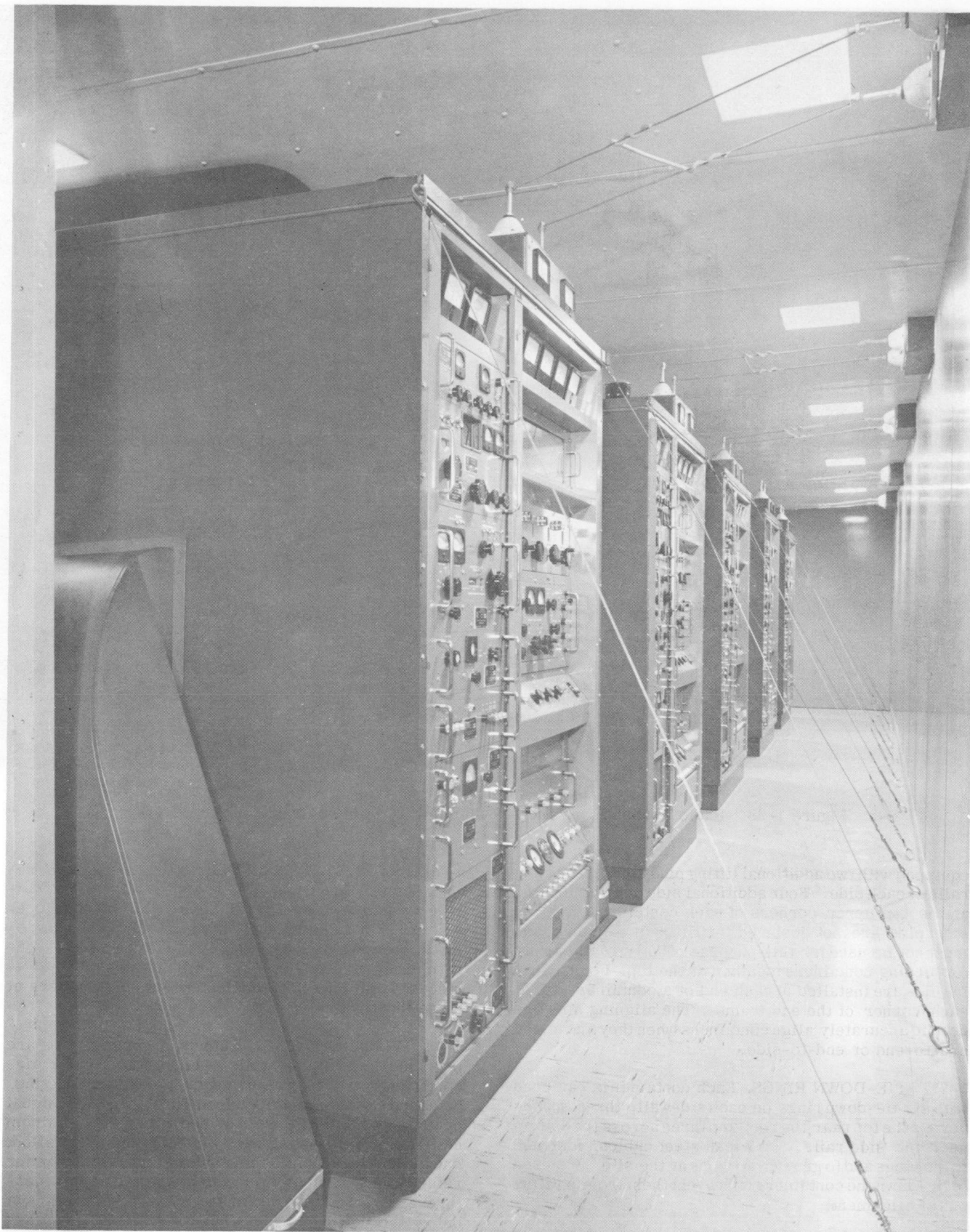

Figure 1-37. Radio Transmitting Set AN/TRT-17, 10-K (TA1, TA2 and TG2)

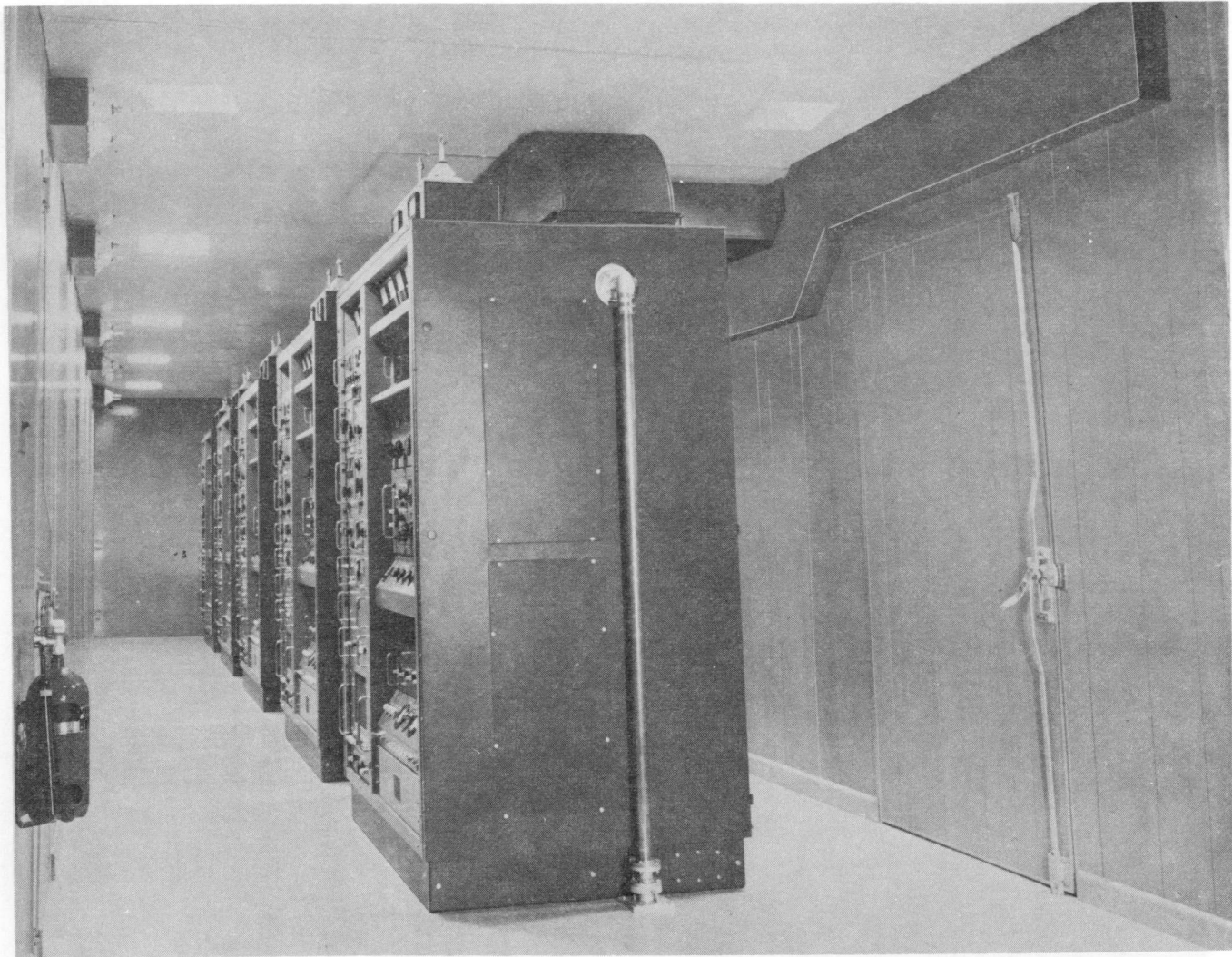

Figure 1-38. Radio Transmitting Set AN/TRT-17, 10-K (TB2, TB3, TC4, and TD4)

equipped with two additional lifting pins along the bottom rails of each side. Four additional side pins are located at the top upper corners of each container. The top side pins are not designed for lifting a container and must not be used for this purpose. They are used only for locking containers together at the top. Four aligning pins are installed at each end of a container, one at each corner of the end frame. The aligning pins are used to accurately align containers when they are mated end-to-end or end-to-side.

1-71. TIE-DOWN RINGS. Each container is equipped with six tie-down rings on each sidewall, three spaced across the top near the roof and three across the bottom near the side rails. Stainless steel cables, fastened to the rings and to ground-anchors at the site, are used to tie-down the containers to prevent them from shifting out of alignment.

1-72. ROOF WALKWAYS. Walkways of closely spaced safety-treads are installed on the roofs of all containers for the protection of personnel.

1-73. SIDEWALL REINFORCEMENT. Sidewall reinforcement and hardware are installed in the outside walls where needed for mounting air-conditioner units, end-frames (used for mating containers end-to-side), and side-to-side walkways between wings. The reinforcement consists of additional structural steel pieces welded to the existing structural members at these locations.

1-74. WALL CUTOUTS. Cutouts of various sizes are provided in container walls wherever needed for air-conditioner ducting, transmitter air exhaust ducting, balanced output assembly feed-throughs, and signal ducts. Two cutouts are provided above the aluminum ceiling near the roof for each air conditioner installed, one for feeding air into the container and the other for return air. Transmitter air-exhaust and RF feed-through assembly cutouts are provided in sidewalls just below the ceiling level. Cutouts for signal duct are made either in end walls or ever side-to-side walkways near ceiling level. All cutouts are protected with dust covers during transport.

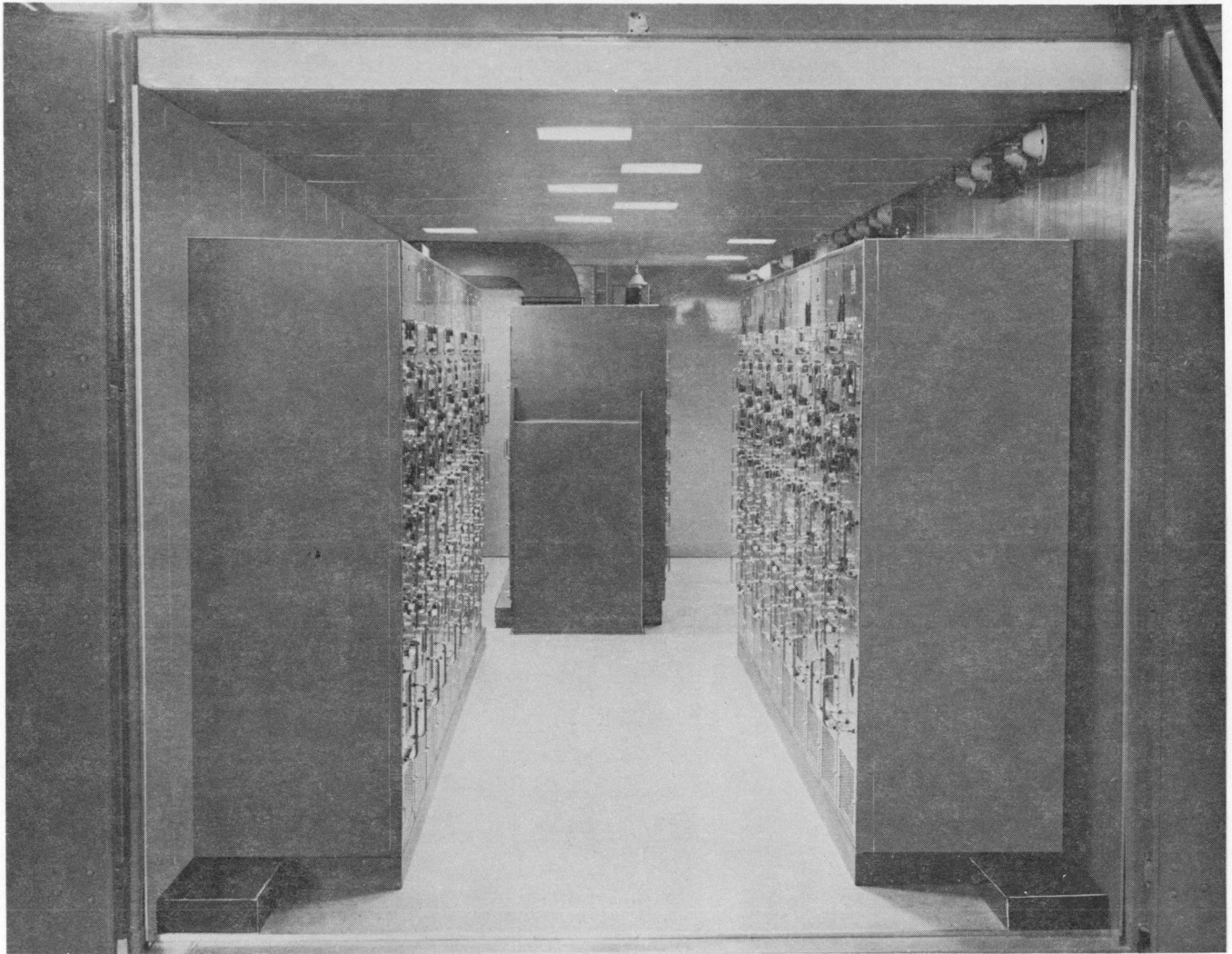

Figure 1-39. Radio Transmitting Set AN/TRT-23, 1K and 10K (TA3, Front Area)

1-75. CONTAINER INTERIOR.

1-76. TAPPING PLATES. Steel tapping plates are provided in the walls and floors wherever needed for securing rackbases, racks, equipment, cabinets, and furniture. The tapping plates, which are welded to the inside surfaces of wall and floor structural members, are 3/8-inch thick steel plates that are cut to various widths and lengths to accommodate different mounting requirements. The plates are drilled and tapped for mounting bolts at the time equipment is being installed in the containers.

1-77. POWER CONTAINERS. In the containers housing generators, additional structural support required for mounting the generators and diesel engines is provided by I-beams installed on the floor cross-beams, lengthwise down the middle of the containers. The generators and diesel engines are bolted to these added I-beams. To provide adequate ventilation for the diesel engines, each sidewall of a generator container is converted into two 30-foot horizontal doors. The bot-

tom door opens downward to form a walking surface and the top door opens upward providing a roof over the walking surface. The power control and distribution containers are equipped with I-beams installed lengthwise over the floor cross-beams to provide adequate cable ducts for large power cables.

1-78. FLOOR, WALLS, AND CEILING. The floors are finished with vinyl tile, the walls with driftwood tupelo-gray plywood, and the ceiling with perforated aluminum sheets. Between the aluminum ceiling and insulated roof is an air space approximately 8 inches high that is partitioned with two Z-bars extending nearly the full length of a container. The two Z-bars are joined with cross pieces near both ends of the container forming a middle duct section that is completely surrounded by an outside duct section. Conditioned air is fed into the middle duct and then flows into the container interior through the perforated ceiling. Air is returned to the air-conditioner units in the reverse manner through the outside duct. Interior ceiling



Figure 1-40. Radio Transmitting Set AN/TRT-23, 1K and 10K (TA3, Rear Area)

lights are mounted flush with the aluminum ceiling, the fixtures being recessed into the duct areas.

1-79. AIR-INTAKE CUTOUTS. Transmitters that require forced air cooling are furnished air through cutouts in the container floors. The air intake cutouts are equipped with dust filters and are protected with dust covers during transport.

1-80. For additional details of AN/TSC-35 container construction, refer to Volumes 2 and 3 of this manual. For on site installation instructions of the containers and their accessories, refer to the instruction manual, Container for Housing Electronic Equipment, WF-TWIN-20M-TMC-1, which is furnished with the system.

1-81. EQUIPMENT MOUNTING AND INSTALLATION.

All electronic equipment designed for rack-mounting is installed in AN/TSC-35 equipment racks that in

turn mount on rack bases especially designed for this installation. Other equipments, such as most transmitters and the diversity receivers that are housed in special racks of their own, are mounted on special bases. Most teletype equipment, furniture, safes, filing cabinets, storage and parts cabinets, desks, etc., mount directly on the floor.

1-82. All rack bases are bolted to the steel tapping plates in the container floor described earlier. Equipment racks are bolted to the bases and to steel tapping plates in the walls near the tops of the racks. Other equipment and furniture which are mounted on rack bases are installed in the same manner. Equipment and furniture that mount directly on the floor are bolted to tapping plates in the floor and walls. All transmitters that are mounted in the center of containers some distance from walls are bolted to their bases and are provided with removable tie-down frames and hardware for use during container transport. Lightweight equipment, furniture and other items such as fire-extinguishers, small shelves, signal duct, raceway,



Figure 1-41. Radio Transmitting Set AN/TRT-18, 40-K (TB1 and TH1)

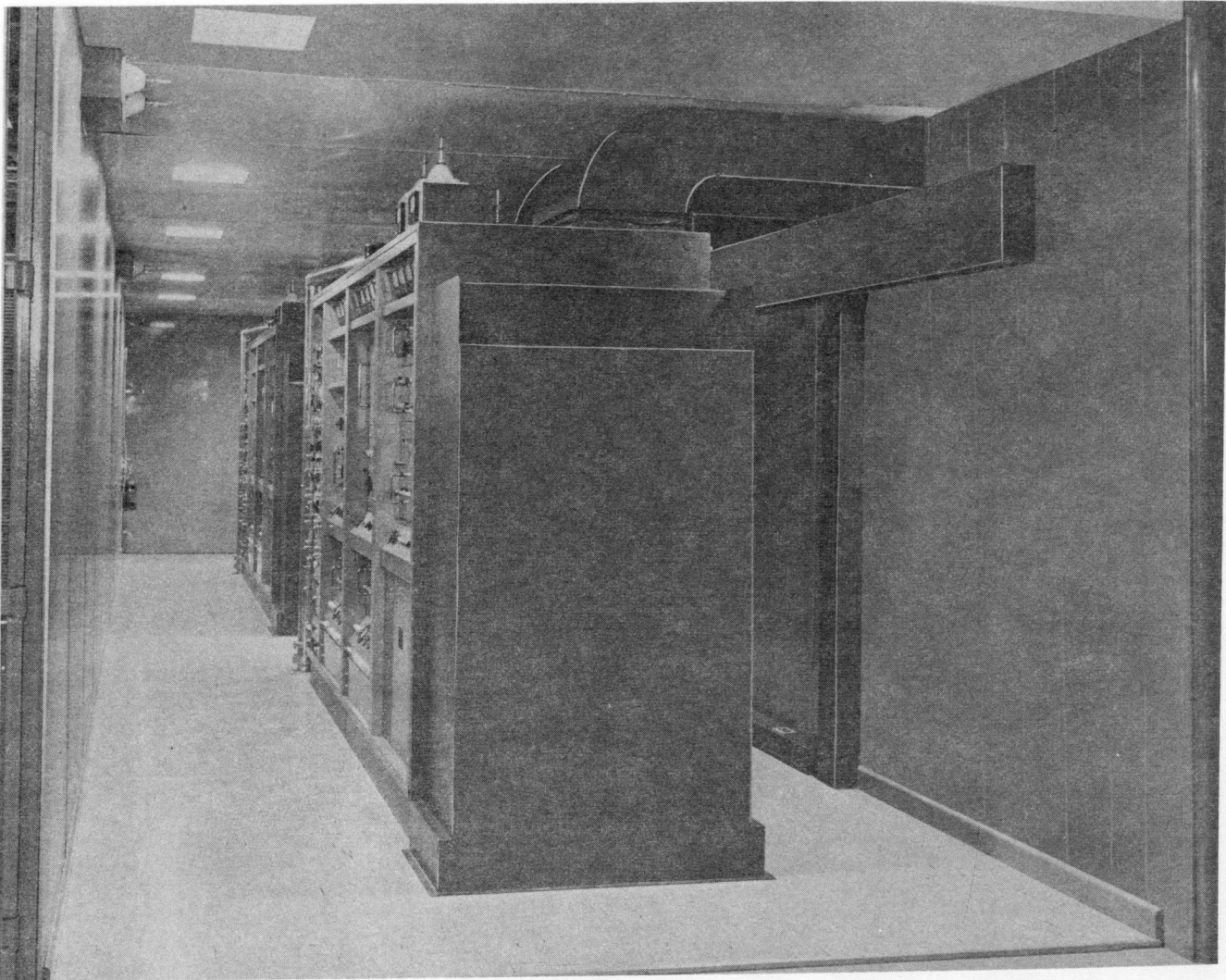

Figure 1-42. Radio Transmitting Set AN/TRT-18, 40-K, (TC2, TC3, TD2, TD3 and TG3)

etc., are bolted to the container walls with expansion type fasteners.

1-83. STANDARD RACK BASE.

The standard AN/TSC-35 rack base is 27 inches wide, 4 inches high, and the length is determined by requirements at any individual location. The standard rack base is divided lengthwise into three compartments which are used for signal and AC duct and is constructed of steel to provide ferrous shielding for the signal and AC circuits. The base is generally installed against the wall of a container. The outer compartment of the base (along the wall) and the inner compartment (along the aisle) are used for signal duct. The middle compartment of the rack base is used for AC duct. Where RED and BLACK signal cables are run in the same base, the outer duct is used for the RED signal cables and the inner duct for the BLACK signal cables. Ferrous cover plates are used on the

rack base in all RED areas. The base extends beyond equipment racks where it is necessary to provide an entrance for signal ducting.

1-84. STANDARD EQUIPMENT RACK.

The standard AN/TSC-35 equipment rack is a steel framework 77 19/32 inches high, 27 inches deep, and 20 13/16 inches wide. It can accommodate 43 standard (one and three-quarter-inch) rack units. Steel side and rear skins are provided wherever needed for ferrous shielding. The top of the rack is covered with expanded steel mesh to permit air circulation. Screened ventilation panels are provided at the bottom of those racks where additional air circulation is required.

1-85. RACK AND EQUIPMENT IDENTIFICATION SYSTEM.

Within the containers, each equipment rack and separate equipment is identified by a number consisting of



Figure 1-43. Control Monitor Group OA-4915/TST-2 (TC1, Equipment Installation)

the container number followed by a decimal point and a number, such as RB2.8. The number is a locator or designator that locates the position of a rack or equipment within the container, even numbered locators on the right side of containers and odd numbered locators on the left side. Numbering begins at the rear of a container. In containers where equipment is mounted down the middle such as in most transmitter containers, the equipments or racks are numbered consecutively starting from the rear of the container, such as TA1.1, TA1.2, TA1.3, etc.

1-86. Within a rack, each panel is identified by a locator letter beginning with the letter "A" for the top panel of the rack. A typical example is RB2.8B which locates the second panel of rack .8 (number 8) in container RB2. When two or more units or equipments occupy the same panel space side-by-side, each unit or equipment carries the panel letter designator and a numeral suffix beginning with "1" for the first unit on the left, such as RE2.21A1, RE2.21A2, etc.

1-87. SIGNAL DUCTS.

All AN/TSC-35 signal ducts are of steel construction to provide ferrous shielding for the signal circuits, and are continuous from the operating equipments to the main distribution frames where all the signal circuits terminate. Two completely separated signal duct systems, RED for secure circuits and BLACK for all other circuits, are installed at Receiving Central AN/TSR-1. The RED signal ducting is marked with inch-wide red stripes at approximately 18-inch intervals. At Trans-

mitting Central AN/TST-2, a single black signal duct system is installed. The duct systems are designed for approximately 50-percent cable loading at installation, allowing space for additional cable runs that may be installed in a future expansion of the communication system.

1-88. The duct systems include wall-mounted horizontal and vertical duct, overhead duct, floor duct (inside rack bases), and cross-container duct. The standard AN/TSC-35 duct section has a hinged access door, and a front vertical lip that retains cables when the door is opened. The door is equipped with quick-disconnect fasteners. Various types and sizes of connecting and transition duct pieces are used throughout the duct systems. The most common connecting pieces are TEE fittings, 90-degree elbows, and straight pieces. The straight connecting pieces are used to join two similar duct sections. Transition duct pieces are used to change the level or height of a duct run, to convert from one duct size to another, or to convert the plane in which a duct is run.

1-89. DUCT SIZE.

Standard AN/TSC-35 duct sizes are 4 x 4, 4 x 6, and 4 x 12 (inches). The size used at any location is determined by the cable loading requirements. The duct pieces are 10-foot long sections which can be cut to the exact length required at each location. Rack-base duct is approximately 4 x 9 inches for each section. Cross-container duct is approximately 3 x 12 inches for each section. Smaller duct such as 1700



Figure 1-44. Interconnect Group OA-4916/TST-2 (TD1, Equipment Installation)



Figure 1-45. Interconnect Group OA-4918/TST-2 (TG1, Equipment Installation)

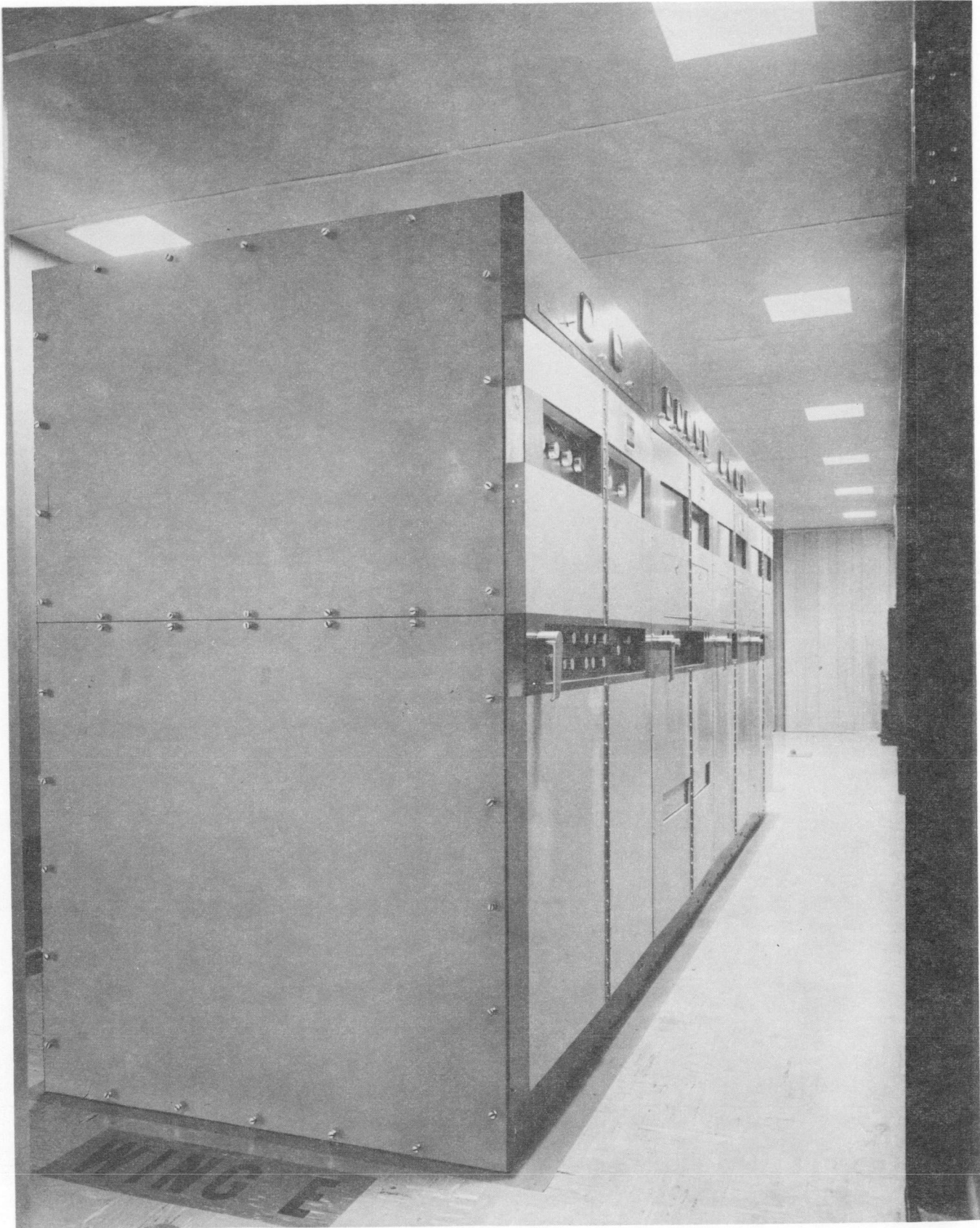

Figure 1-46. Radio Transmitting Set AN/TRT-19, Low Frequency (TE1, Equipment Installation)



Figure 1-47. Maintenance Equipment Group OA-4917/TST-2 (TF1, Shop Area)

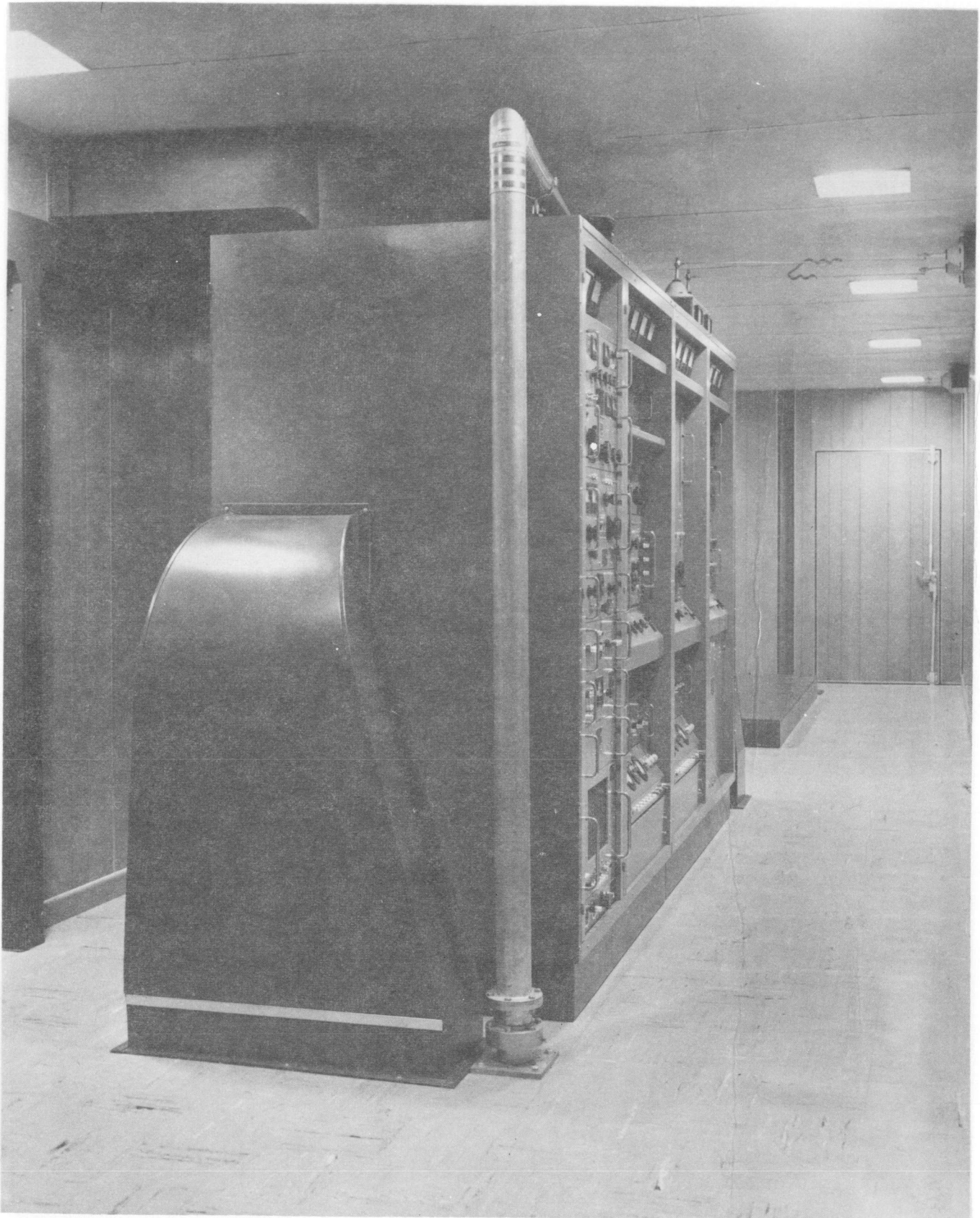

Figure 1-48. Radio Transmitting Set AN/TRT-20 (TH2, 40-K Installation)



Figure 1-49. Radio Transmitting Set AN/TRT-24 (TH3, 200-K Installation)

raceway is often used to carry cables from the other duct types to individual equipments.

1-90. CROSS-CONTAINER DUCT.

Cross-container duct is constructed by welding steel plates onto adjacent floor structural members under the container. This provides duct from one side of a container to the other side similar to Q-cell construction. Three adjacent cross-container ducts are usually provided at each location, two for signal cable runs and one for AC power wiring. Holes or cutouts for pulling cables through the floor into cross-container duct are provided on each side of the container. The holes are located either inside the appropriate base-duct section or in a kickplate installed over the associated cross-container duct.

1-91. TYPICAL DUCT INSTALLATION.

Horizontal signal duct is bolted to the container walls, usually near the ceiling and extending from one end of a container to the other. Cut-outs are provided in the end-walls for extending the horizontal duct into

adjacent containers. The horizontal ducts in two adjacent containers are mated with 30-inch straight connecting pieces which are installed inside the duct. In a typical container, the ductwork branches off from the horizontal duct through TEE fittings or 90-degree elbows down the sidewalls into base duct or cross-container duct. In the control containers RB1, RE1 and TC1, large duct scoops connect the horizontal duct directly with the main distribution frame racks. Overhead duct is installed against the ceiling by fastening the duct to the structural members that are part of the overhead air-conditioning ductwork. Overhead duct is used where a duct run is changed from one wall to another, or where the duct must cross a container to pass through a side-to-side walkway into another container located in an adjoining wing.

1-92. CONTAINER SUPPORT ASSEMBLIES.

At the site, each AN/TSC-35 container is mounted on two or more special container support assemblies. A typical support assembly installation is illustrated in figure 1-58. Each leg of the assembly is equipped

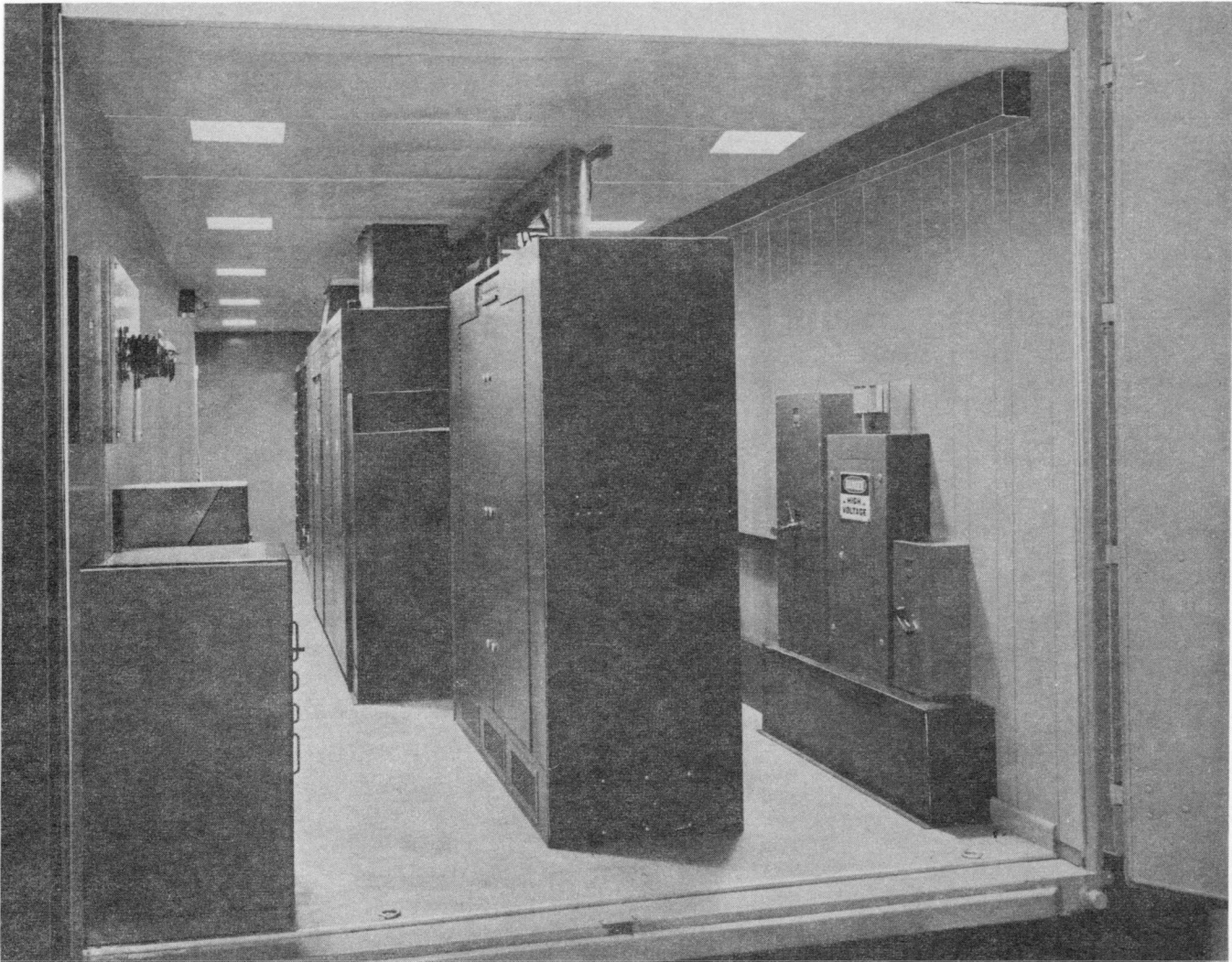

Figure 1-50. Radio Transmitting Set AN/TRT-24 (TH3, Front Area)

with two casters, a swivelled sand shoe, and an independent two-speed jack. The casters are mounted on leaf-springs that support the weight of the assembly and allow one man to easily move the assembly into position under a container. The independent jack in each leg, which can be adjusted to a height ranging from 34 to 50 inches, makes it possible to easily and accurately level the containers on site.

1-93. The jack is operated by a crank handle that slips on and engages a two-speed crank shaft. The crank shaft is pushed inward for slow speed and pulled outward for high speed. Each side of the support assembly is equipped with two driftpins and two rail-clamps that engage the bottom rail of the container. The rail clamps are operated by means of the flat handle shown in the locked (down) position in the upper center of figure 1-58.

1-94. CONTAINER LIFTING SLING.

For shipboard loading and unloading of AN/TSC-35 containers, the special lifting sling illustrated in fig-

ure 1-59 is furnished with the system. The sling has eight wire-rope legs, (four with turnbuckles and four without), end and side spreaders, and fittings that mate with container lifting pins. As previously noted, all containers are equipped with four corner lifting pins, and the generator containers have four additional side lifting pins. When lifting containers, the four legs without turnbuckles are always used, and are always fastened to the corner lifting pins. The additional four legs with turnbuckles are used for lifting generator containers and these legs fasten to the side lifting pins. Container lifting instructions are printed on metal nameplates which are fastened to the outside of all containers.

1-95. AIR CONDITIONERS.

The air conditioners installed in the AN/TSC-35 Communication System are all-weather model MAC-10-S12 Air Conditioning Units. Each unit is capable of providing five tons of cooling capacity at temperatures up to 125 degrees Fahrenheit ambient, and heating

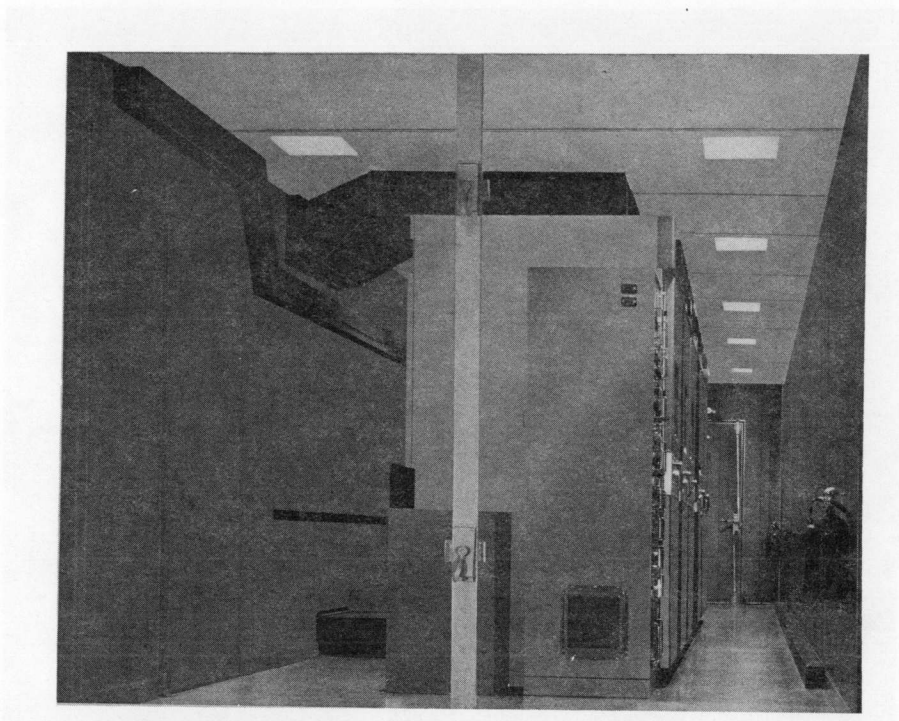

Figure 1-51. Radio Transmitting Set AN/TRT-25 (TH4, 50-K Installation, Rear Area)



Figure 1-52. Radio Transmitting Set AN/TRT-25 (TH4, 50-K Installation, Front Area)

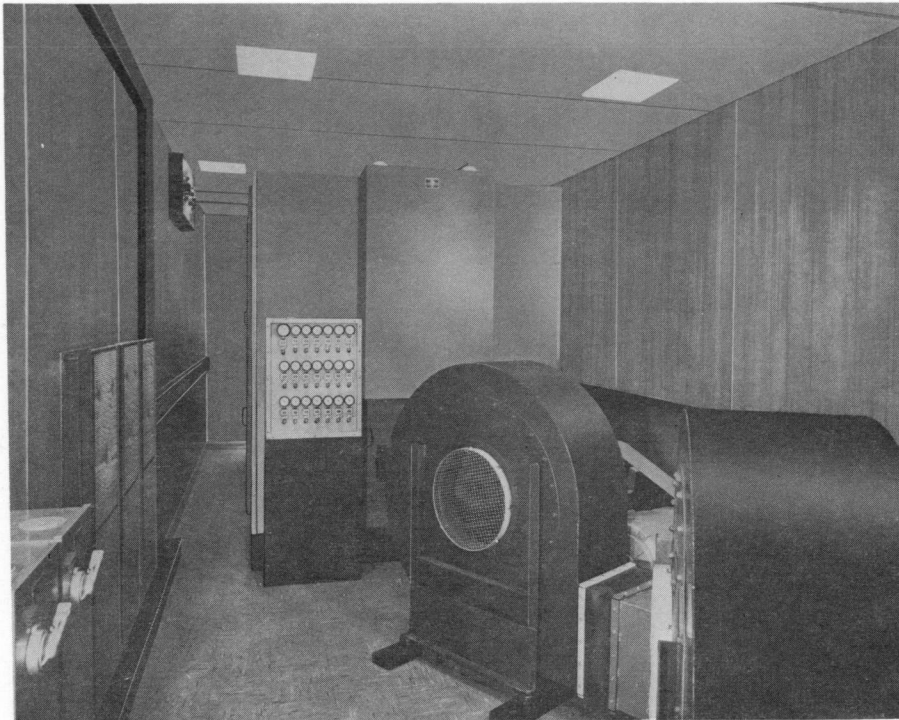

Figure 1-53. Radio Transmitting Set AN/TRT-25 (TG4, Low-Pass Filter)

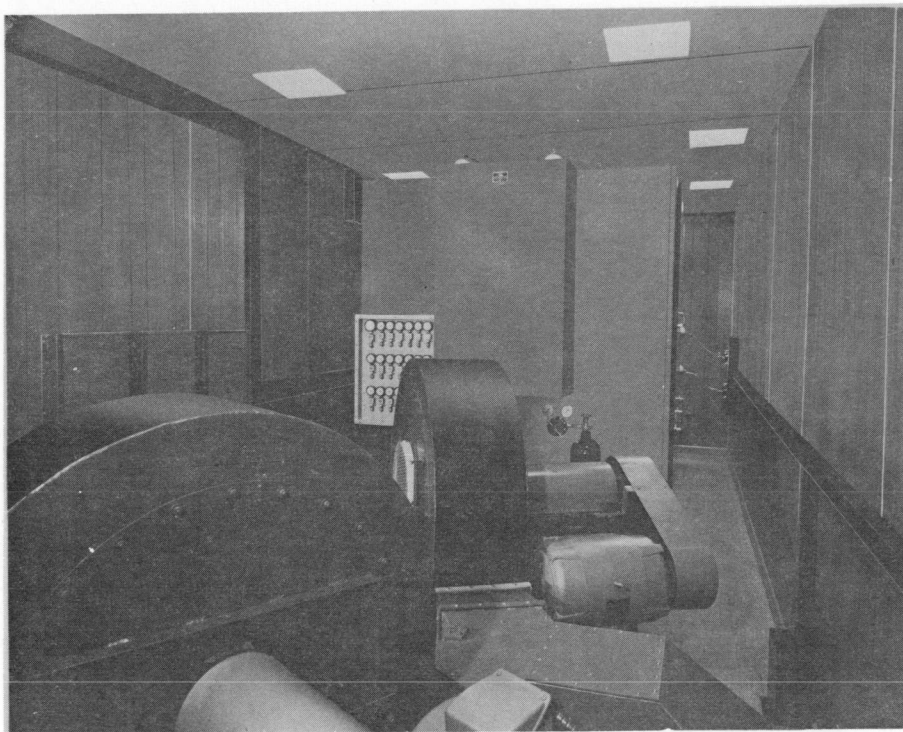

Figure 1-54. Radio Transmitting Set AN/TRT-25 (TG4, Low-Pass Filter)

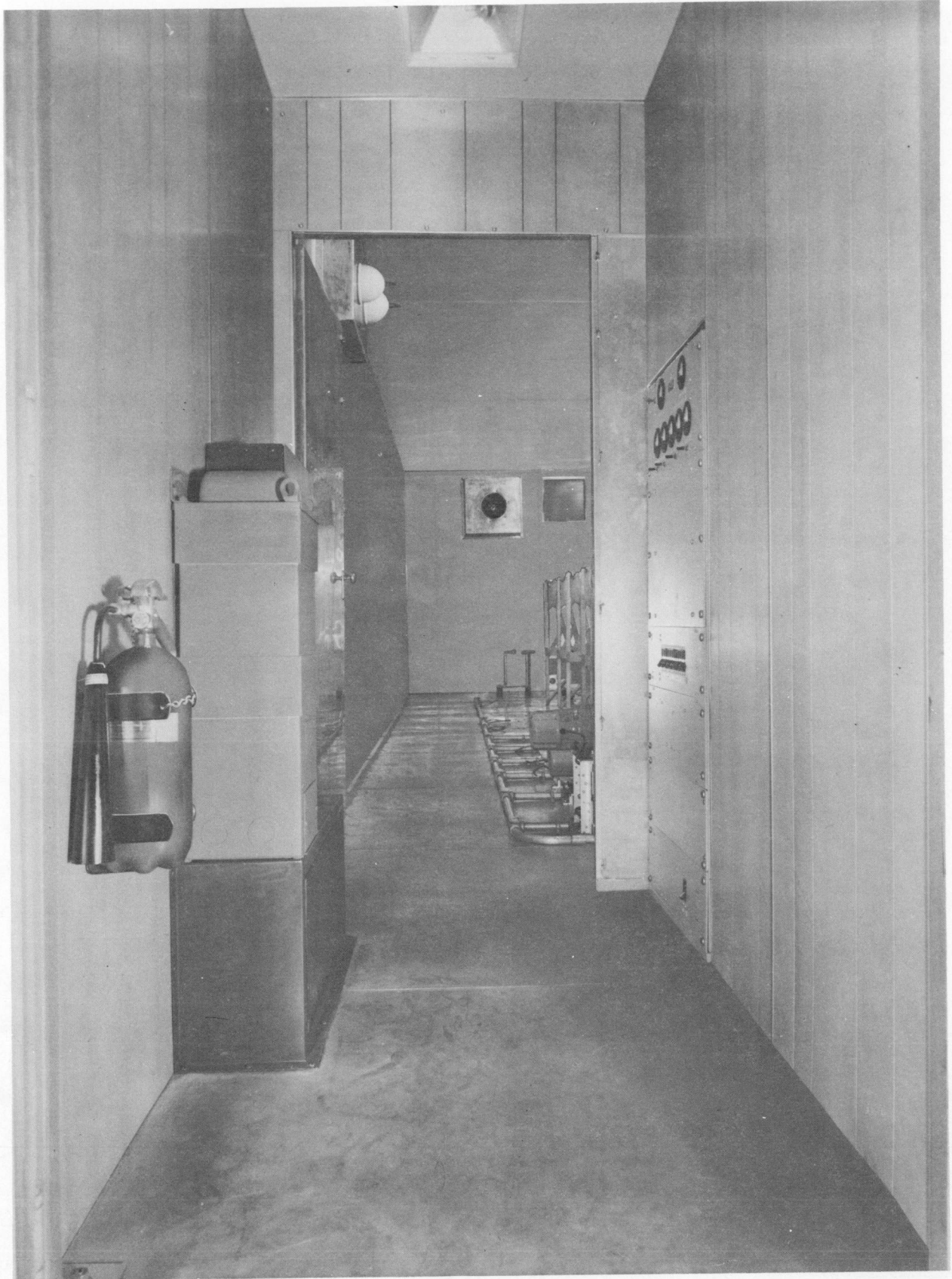

Figure 1-55. Antenna Coupler Group OA-4940/TST-2 (Helix, Vestibule Area)

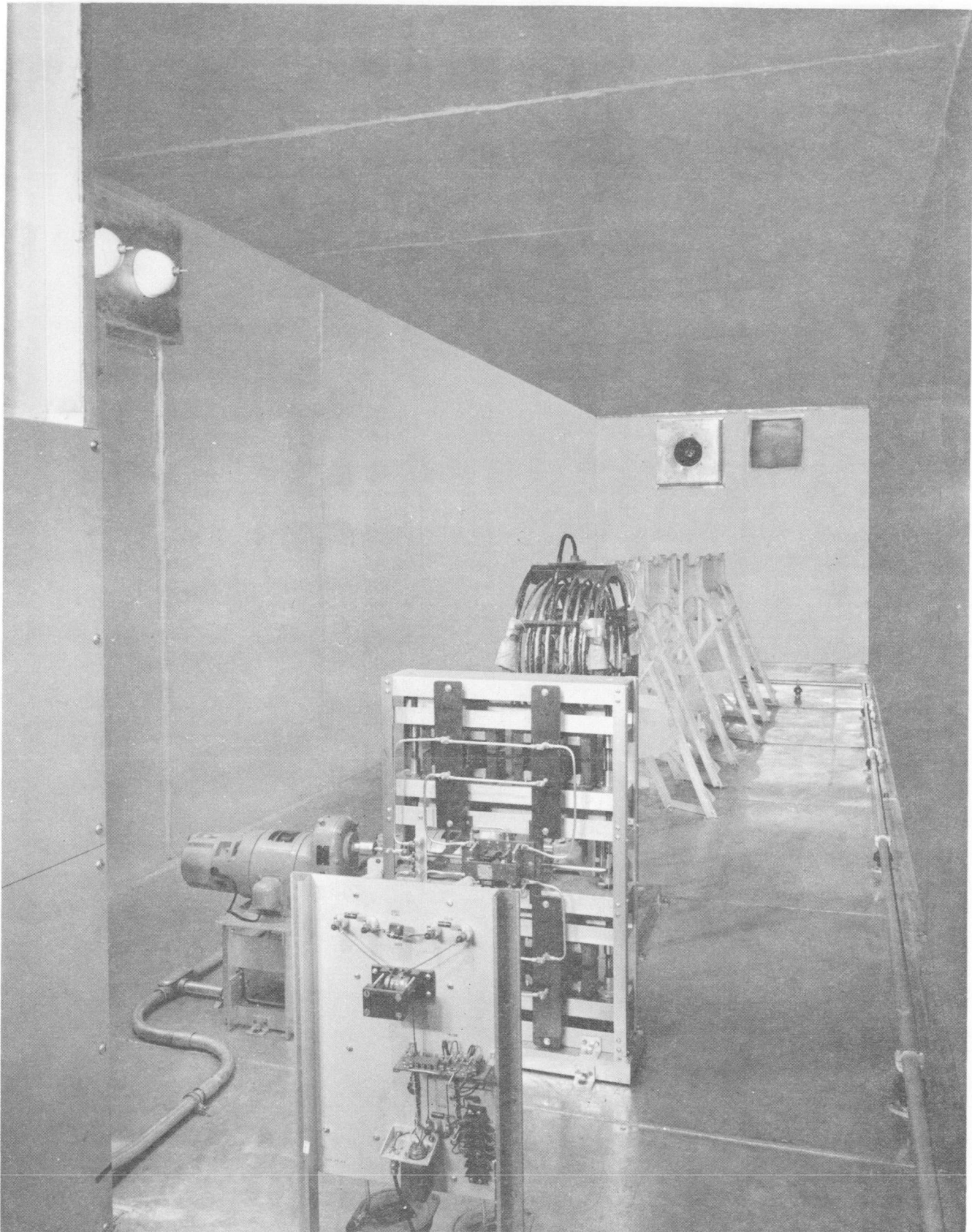

Figure 1-56. Antenna Coupler Group OA-4940/TST-2 (Helix, Equipment Installation)

- NOTES AND VARIATIONS OF CONSTRUCTION
1. END INSULATED PANELS AND EMERGENCY EXIT DOOR WHERE REQUIRED
 2. CUTOUTS AND DOORS RE-ENFORCED WITH TUBING AS REQUIRED PER CONSTRUCTION
 3. PARTITIONS ADDED IN SOME CONTAINERS AS REQ.
 4. FALSE OVERHEAD AND AIR DUCT IN ALL CONTAINERS EXCEPT HELIX AND GENERATOR CONTAINERS. AIR DUCT FRAMING CONSTRUCTED PER CONTAINER EQUIPMENT REQUIREMENTS
 5. END TO SIDE, SIDE INTER-CONTAINER WALKWAY AND AIR CONDITIONER RE-ENFORCEMENT WHERE REQUIRED
 6. ALL UNDER-STRUCTURE IS UNDER COATED
 7. REFER TO ENGINEERING DRAWINGS FOR SPECIFIC TAP PLATE, CUTOUTS AND DUCT LOCATIONS

RIGHT SIDE

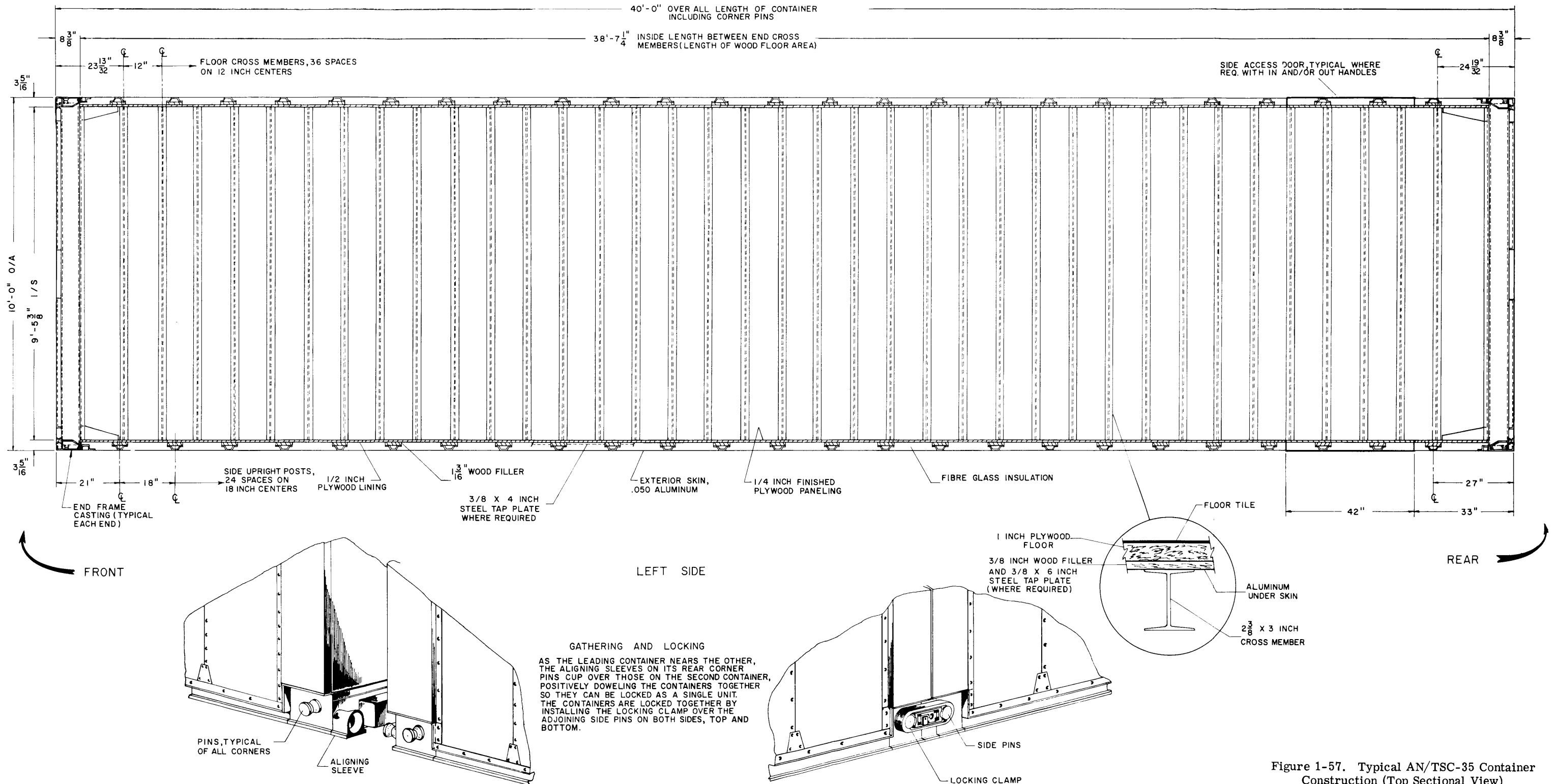

Figure 1-57. Typical AN/TSC-35 Container Construction (Top Sectional View)

capacity of 34, 150 B. T. U. per hour. All containers, except the power distribution, power generator and helix containers are equipped with air conditioners. Most containers equipped with air conditioners have two units, but some have one unit and others three, depending on their individual requirements. The mobile workshop trailer is equipped with one air conditioner.

1-96. Table 1-2 lists the containers that are equipped with air conditioning units and the number of units in each. Each container is equipped with one air-conditioner control unit that can control one, two, or three units. The control unit is located where it can best sense the average temperature and humidity of the air inside the container. The usual mounting place is the top of a circuit breaker panel. A front panel switch of the control unit allows selection of ventilation, cooling with ventilation, or heating with ventilation.

1-97. ELECTRONIC CLOCK SYSTEM EQUIPMENT.

Accurate Zulu and local time is maintained at the Receiving Central by a Dual Timer Clock System consisting of a Model 300142 master electronic clock controlled by an accurate secondary frequency standard. The master clock feeds a Model 300145 clock control drawer that distributes time information pulses to six Model 300129 dual and two Model 300132 single readout units distributed throughout the receiver site. Refer to figure 1-60 for the clock system block diagram and locations of the readout units. A description and operating instructions for the clock system is contained in a separate instruction manual supplied with the system.

1-98. VOICE INTERCOM EQUIPMENT.

Inter-communication between key areas of the receiving central is provided by two completely separate voice INTERCOM systems, one RED and the other BLACK. The RED INTERCOM system consists of ten Model MS2312LLS INTERCOM units that provide communication between key classified areas. The BLACK INTERCOM system is comprised of ten Model MS2312LLS units located primarily in unclassified sections of the receiver site. Installation and operating instructions for the voice inter-communication equipments are contained in a separate manual supplied with the system. At the Transmitting Central, a two-station INTERCOM system links control containers TC1 and GT2.

1-99. STATION INTERNAL TTY ORDER-WIRE SYSTEM.

A teletype order-wire (O/W) system is used for official traffic between key operating areas of the station. The O/W system consists of nine send/receive teletype units linked together by means of an audio frequency carrier system which allows two-way traffic in a half-duplex type of operation. One TTY order-wire unit is located in the transmitter control container TC1, and the remainder are distributed throughout the receiving central. A detailed description of the TTY O/W system is contained in Volume 2 of this manual.

1-100. MICROWAVE EQUIPMENT.

A microwave system consisting of two sets of 74B-1 microwave transmitters and receivers operating in the 8175/8365-megacycle band and two AN/FCC-17 voice terminals provide a reliable communication link between the Receiving and Transmitting Central sites. The transmitters and the receivers are backed-up with automatically switched "hot-standby" units. At the Receiver site, the microwave and terminal equipments are installed in container RE2 with the associated microwave antenna mounted on a 40-foot tower adjacent to the container. At the Transmitter site, container TC1 houses the microwave and terminal equipments. The microwave antenna is mounted on the roof of TC1 and an associated microwave reflector on a 100-foot tower near the container. The system provides sixty 3-kc send channels from the receiver site to the transmitter site, and twenty-four 3-kc send channels from transmitters to receivers. Twelve of the send and receive channels are relayed through the transmitter site to a distant point for intercommunications with other communication systems. Thirty-six more channels from transmitters to receivers can be realized by the addition of plug-in modules at both sites.

1-101. ANTENNAS AND TRANSMISSION LINES.

The quantities and types of antennas that are installed at the Communication System AN/TSC-35 are listed in table 1-3. RF feedlines from receiving antennas are type FHJ-4 and FHJ-5 coaxial cables. Receiving antenna locations and coaxial cable terminations are covered in Volume 2 of this manual.

1-102. Transmitting antenna RF feedlines are 3-inch HJ8-50A coaxial cables, 600-ohm balanced open-wire lines or single-wire feedlines. The coaxial cables are run at ground level and through conduit below the surface at road crossings. Balanced and single-wire feedlines are supported on poles that provide 15-foot clearance above ground level. A ten-foot minimum spacing is maintained on the poles between adjacent RF transmission lines. Installation details of transmission line poles, transmission lines, and antennas are contained in Section 2, Volume 3, of this manual.

1-103. PRIMARY ELECTRIC POWER PLANTS.

Two independent primary power plants furnish the AC power required to operate the Transportable Communication System AN/TSC-35. One power plant is located at the Receiving Central and the other at the Transmitting Central.

1-104. RECEIVING CENTRAL ELECTRIC POWER PLANT AN/TSQ-56.

The electric power plant at the Receiving Central includes power distribution container GR1, power control container GR2, two generator containers GR3 and GR6, and two No-Break power containers GR4 and GR5.

1-105. The power distribution container houses a main power bus, a No-Break power bus, and one or more circuit breakers for each container and each RLPA antenna at the receiving site. The power control

TABLE 1-2. AIR CONDITIONING UNITS INSTALLED

RECEIVING CENTRAL AN/TSR-1	
Container	No. of Units
RA1	1
RA2	2
RA3	2
RB1	2
RB2	3
RB3	3
RC1	2
RD1	1
RD2	1
RE1	2
RE2	1
RE3	2
RE4	2
RF1	1
RF2	2
RF3	1
RG1	1
RH1	1
RJ1	2
RJ2	2
GR2	1

TRANSMITTING CENTRAL AN/TST-2	
Container	No. of Units
TA1	2
TA2	2
TA3	2
TB1	2
TB2	2
TB3	2
TC1	1
TC2	2
TC3	2
TC4	2
TD1	1
TD2	2
TD3	2
TD4	2
TE1	2
TF1	1
TG1	1
TG2	2
TG3	2
TG4	1
TH1	2
TH2	2
TH3	2
TH4	3
GT2	1

TABLE 1-3. COMMUNICATION SYSTEM AN/TSC-35 ANTENNAS

TYPE	QUANTITY		CHARACTERISTICS	MANUFACTURER
	RECEIVING CENTRAL	TRANSMITTING CENTRAL		
OCM-68	1	10	Conical Monopole, 2-8 Mcs.	Dixon Industries, Inc.
OCM-28	1	8	Conical Monopole, 4-16 Mcs.	Dixon Industries, Inc.
OCM-17	1	10	Conical Monopole, 7-28 Mcs.	Dixon Industries, Inc.
237A-1A	6	10	RLPA, 6.5-60 Mcs.	Collins Radio Co.
FDA-3-600R	11	14	3 Wire Vertical Doublet, 6-32 Mcs., 600 ohms 2 Wire Ctr. Fed.	Trylon, Inc.
RLW	2		(1) 600 ft. and (1) 700 ft.	Trylon, Inc.
TLW		2	(1) 417 ft. and (1) 917 ft.	Trylon, Inc.
726-1	2		FLPA, 2.5-32 Mcs.	Granger Assoc.
775		1	Conical Monopole, Tuned 4-30 Mcs.	Granger Assoc. (G. F. E.)
	12	14	Rhombic	G. F. E.
F-11	2		VHF, 100-174 Mcs.	TACO
AT-197	1		UHF, 225-400 Mcs.	TACO
AT-150	1	1	UHF, 225-400 Mcs.	G. F. E.
PAN POLAR 630-ft. Tower		1	LF	G. F. E.
PAN POLAR 359-ft. Tower		1	LF	G. F. E.

container houses a power control console and contains an electrically operated 3-phase, 1600-ampere circuit breaker for each diesel-generator unit at the receiver site power plant. Each generator container houses three 335-kilowatt, 208-volt, 3-phase diesel-driven generators that can furnish a total of 1005 kilowatts of standard AC power. Each No-Break power container houses a No-Break power system that can furnish 200 kilowatts of highly regulated 208-volt, 60-cycle, 3-phase power for critical communication areas.

1-106. TRANSMITTING CENTRAL ELECTRIC POWER PLANT AN/TSQ-55.

The Transmitting Central power plant includes power distribution container GT1, power control container GT2, and four generator containers GT3, GT4, GT5, and GT6. The generator containers are identical to their counterparts at the Receiving Central, each one providing 1005 kilowatts of standard power. The power distribution container is equipped with one common

power bus, and one or more circuit breakers for each container and each RLPA antenna drive circuit at the transmitter site. The power control container houses a power control console and one electrically operated 3-phase, 1600-ampere circuit breaker for each diesel-generator unit in the transmitter power plant.

1-107. POWER PLANT TYPICAL OPERATION.

In normal operation, two generator units in each generator container furnish power to the system while the third generator unit is in a standby status. At the Receiving Central, one No-Break power unit is on the line while the other is in standby as a maintenance spare.

1-108. The generators are started, synchronized, and placed on the line from a control console in the associated power control container. Power is fed from each generator unit to a 1600-ampere circuit breaker in the control container. These circuit breakers, which are

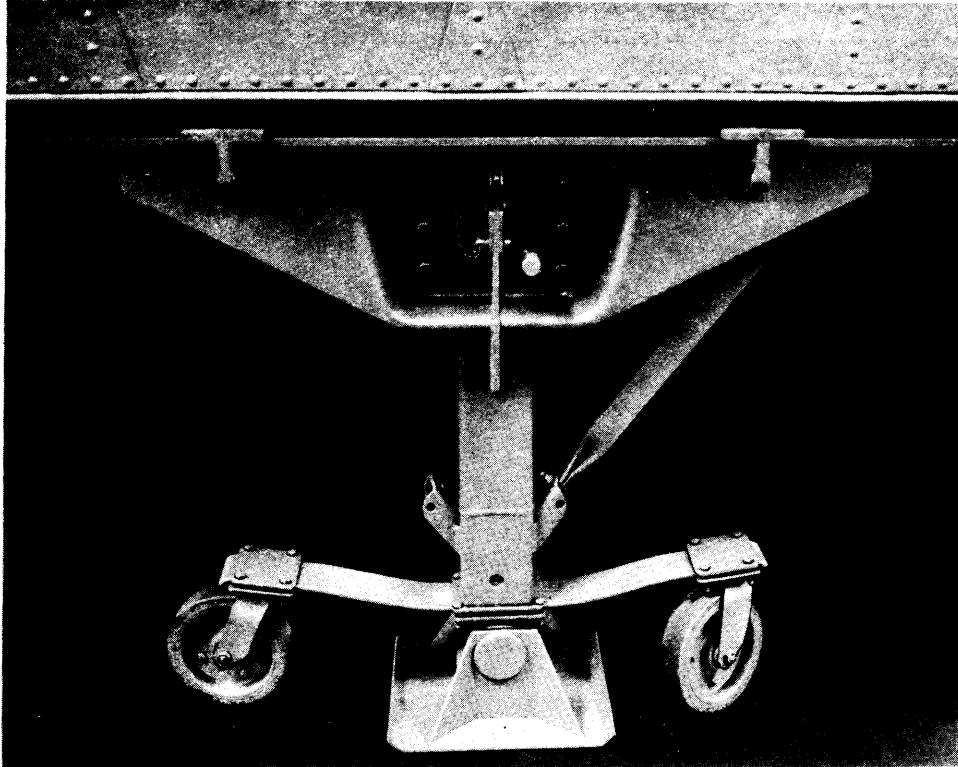

Figure 1-58. Container Support Assembly

electrically operated from the control console, then feed the standard power to a main power bus and the No-Break power to a No-Break power bus in the power distribution container. From each power bus, primary power is then distributed through the individual circuit breakers that service the containers and antennas.

1-109. No-Break power is supplied to containers RA3, RB1, RB2, RB3, and RC1, and standard power to the remaining containers and the antennas. In the event of complete failure of the No-Break power system, standard power can be switched to those containers that are normally supplied with No-Break power.

1-110. POWER CABLE INSTALLATION.

1-111. GENERAL. The following information relative to power cable installation applies to both sites of the Communication System. The primary concern at installation is that power cables between the power distribution container and individual containers are connected in an identical manner. This is in reference to:

1. Phase Rotation
2. Cable Identification
3. Terminal Identification at each end
4. Color Code

1-112. MATERIAL AND EQUIPMENT PROVIDED. The following material and cable installation equipment are provided.

a. Cable. Interconnecting power cable between the distribution container and the individual equipment containers is direct burial type RHW 4-conductor consisting of three #4/0, 427-strand conductors color coded BLACK, WHITE, and RED, and three stranded, tinned, ground wires. Additional power cables for containers TH3 and TH4 include nine runs of 500MCM cables to each container, two per phase and three neutral conductors.

b. Cable Cutter. A #366 cable cutter is provided and recommended for use in cutting all power cables.

c. Connectors. Power breakers in the distribution container are provided with main lugs. #54167 compression connectors are provided for the equipment container end of power cables. These connectors will have to be drilled to take 1/2" studs. A compression tool, type TBM-5, with PURPLE coded die is provided for installation of the above connectors.

d. Cable Puller. A grip type cable puller is provided for pulling the #4/0 power cables.

e. Cable Hangers. Cable hangers are provided for installation under containers after all power cables have been routed.

f. Cable Marking. All cables are marked at both ends with cable markers.

g. Test Device. A phase Sequence Indicator, Model K3, is provided for checking the phase rotation of the main power.

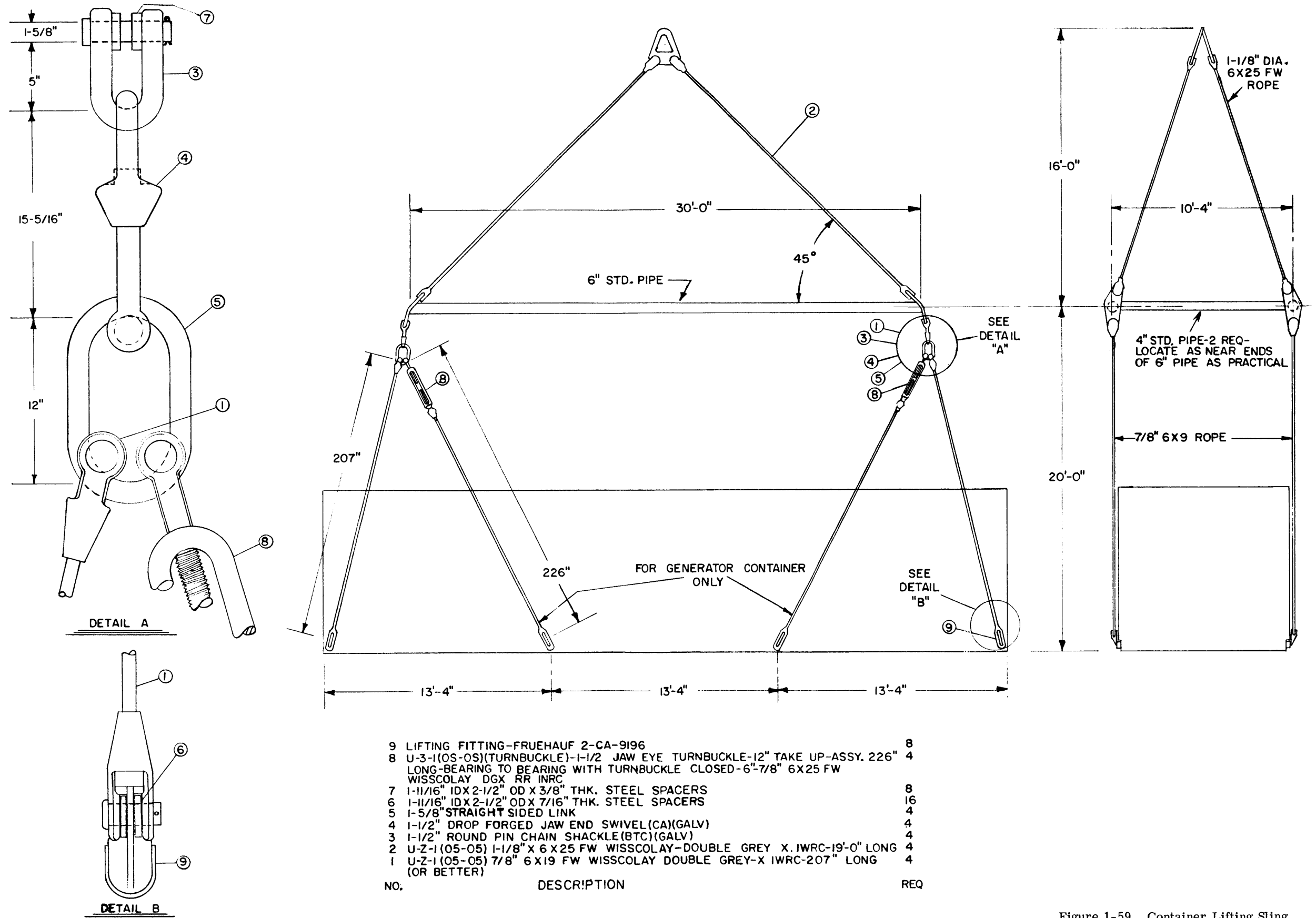
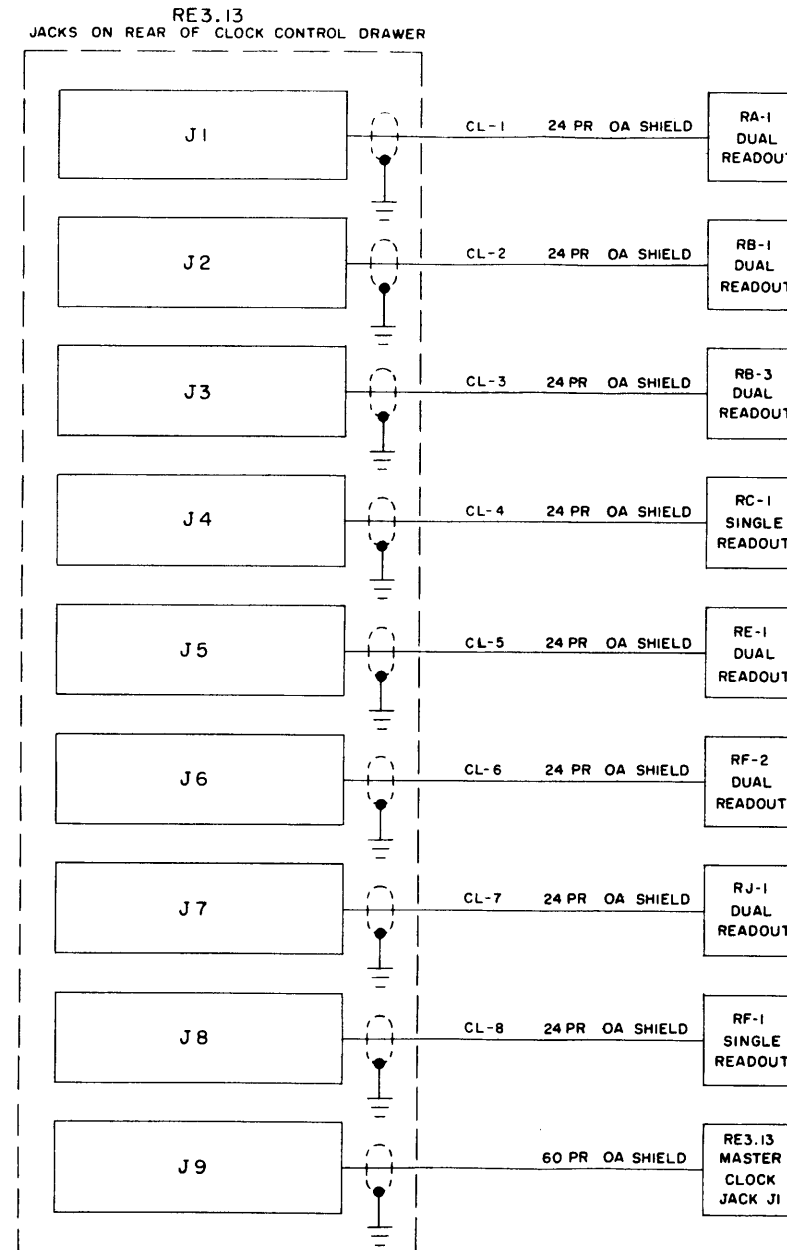

Figure 1-59. Container Lifting Sling



TYPICAL WIRING JACKS J1 THRU J8 ON CLOCK CONTROL DRAWER

CLOCK CONTROL MALE CONNECTOR J1 THRU J8		
WIRE NO.	COLOR	TERM
1	W	A
2	BK	B
3	W	C
4	RED	D
5	W	E
6	OR	F
7	W	H
8	Y	J
9	W	K
10	BL	L
11	W	M
12	GN	N
13	W	P
14	BR	R
15	BK	S
16	RED	T
17	BK	U
18	OR	V
19	BK	W
20	Y	X
21	BK	Y
22	BL	Z
23	BK	a
24	GN	b
25	RED	c
26	Y	d
27	RED	e
28	BL	f
29	RED	h
30	GN	j
31	RED	k
32	BK	m
33	OR	n
34	Y	p
35	OR	r
36	BL	s
37	OR	t
38	GN	u
39	OR	v
40	BK	w
41	Y	x
42	BL	y
43	Y	z
44	GN	AA

DIGITAL READOUTS DUAL OR SINGLE FEMALE CONNECTOR	
TERM	NOTES
A	MINUTES 0
B	1
C	2
D	3
E	4
F	5
H	6
J	7
K	8
L	9
M	MIN x 10 0
N	1
P	2
R	3
S	4
T	5
U	HOURS(TOP) 0
V	1
W	2
X	3
Y	4
Z	5
a	6
b	7
c	8
d	9
e	HOURS x 10 0
f	1
h	2
j	HRS(BOTTOM) 0
k	1
m	2
n	3
p	4
r	5
s	6
t	7
u	8
v	9
w	HOURS x 10 0
x	1
y	2
z	+ 240 VDC
AA	+ 240 VDC

NOTES:

1. EACH CABLE SHIELD WILL BE TIED TO A COMMON GROUND IN RACK RE3.13.
2. 60 PR CABLE FROM J9 OF CLOCK CONTROL DRAWER IS FACTORY WIRED & FURNISHED.

Figure 1-60. Clock System Equipment Location, Cable, and Wiring List

- 1. AIR CONDITIONER UNIT
- 2. PARTS STORAGE CABINET
- 3. AIR COMPRESSOR UNIT
- 4. WORK BENCH
- 5. TOOL STORAGE
- 6. AC POWER OUTLETS (TYPICAL EACH SIDE)
- 7. PARTS CLEANER
- 8. DRILL PRESS
- 9. AC POWER BREAKER PANEL
- 10. AIR CONDITIONER CONTROL
- 11. VALVE GRINDER

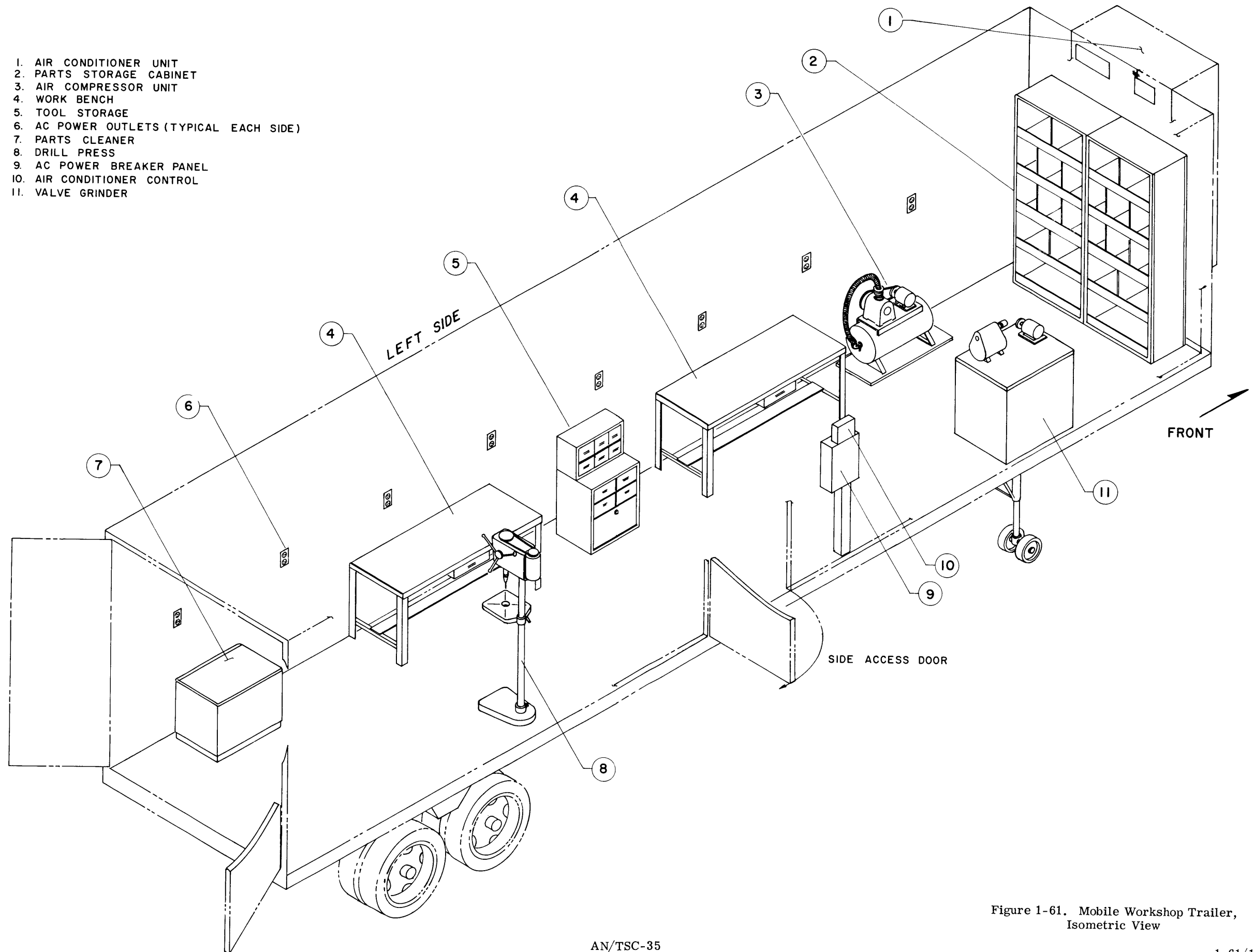

Figure 1-61. Mobile Workshop Trailer,
Isometric View

1-113. INSTALLATION PROCEDURES. Each main power breaker in the distribution container is marked for the particular equipment container it serves, i. e., TH1, RE2, etc. The main lugs on these breakers are marked, from left to right, A, B, and C to correspond to Phase 1, Phase 2, and Phase 3 respectively.

WARNING

DO NOT work on power cables in equipment containers unless the cable is physically disconnected or the breaker is in the OFF position at the power distribution container.

- a. Check each breaker prior to any cable connections to assure a clockwise phase rotation.
- b. Before any particular cable is cut, it must be checked to assure sufficient length is provided for proper connection, and that it is routed correctly.
- c. As each cable is run, mark each end to correspond with the container breaker it serves.

NOTE

The power cables enter the equipment containers through cable feed-thru stuffing tubes installed in 2-1/2-inch holes that are cut in the floor below power distribution panels. Each cable is terminated on a melamine terminal board equipped with four terminal studs that are labeled, from left to right, GRD, PHASE 1, PHASE 2, and PHASE 3. One cable feed-thru and one melamine board are provided for each power distribution panel installed in an equipment container.

- d. The pipe plugs in the cable feed-thru on equipment containers must be removed and the cable clamp portion of the feed-thru, which is in a cloth bag tied to the terminal board inside the equipment container, must be installed prior to running cable through the feed-thru.
- e. Measure, trim and cut the power cable, and install compression connectors inside the container. Note that the ground leads and the red lead is cut longer than the black and white leads. This facilitates connection to the terminal studs.
- f. Connect power cable to terminal studs on melamine board as follows: BLACK to PHASE 1 stud, WHITE to PHASE 2, RED to PHASE 3 and the three ground wires to the GRD stud. After lugs are connected to terminal studs, tighten compression bushing to seal cable and then tighten cable clamp portion of feed-thru to relieve strain on sealing bushing and terminal board.

g. Connect cable in power distribution container to proper breaker.

1-114. POWER SYSTEM MANUALS.

For a complete description of the generator and diesel engine, and installation, operating, and maintenance instructions for the AN/TSC-35 power plants, refer to the following two instruction manuals which are supplied with the system:

Transportable Communication System SYM-2005 (AN/TSC-35) Primary Power System.

and

Operation and Maintenance Instructions for MODEL PFS 200 PNB "NO BREAK" ELECTRIC POWER SYSTEM.

1-115. AN/TSC-35 ELECTRONIC EQUIPMENT.

Table 1-4 lists the electronic equipments that are part of the U. S. Navy Transportable Communications System AN/TSC-35. The list includes both operating and test equipments.

1-116. TOOLS AND MAINTENANCE MATERIAL SUPPLIED.

Tools and miscellaneous materials furnished with the AN/TSC-35 for maintenance purposes are listed in Tables 1-5 through 1-9. The tools consist of ten portable tool kits, ten electronic work bench kits, two sets of antenna field tool kits, and two heavy duty work bench kits.

1-117. PORTABLE TOOL KITS.

Eight of the portable tool kits are for use at the Receiver site and the remaining two at the Transmitter site. Table 1-5 lists the contents of each portable tool kit.

1-118. ELECTRONIC WORK BENCH KITS.

The electronic work bench kits, consisting of the tools listed in table 1-6, are distributed one to each of the following workbenches:

Workbench numbers 1, 2, and 3 in containers RD1, and RA2.

Workbenches 1 and 2 in container RH1.

Workbenches 1 and 2 in container TF1.

1-119. ANTENNA FIELD TOOL KITS.

The antenna field tool kits, one at each site, are comprised of the items listed in Table 1-7.

1-120. HEAVY DUTY WORK BENCH KITS.

Workbench number 4 in container RD1 and workbench number 3 in container TF1 are each equipped with a heavy duty workbench kit consisting of the items listed in Table 1-8.

1-121. MISCELLANEOUS MAINTENANCE MATERIAL.

The miscellaneous maintenance material is for use at both sites and is distributed as indicated in Table 1-9.

TABLE 1-4. AN/TSC-35 EQUIPMENT LIST

MODEL NUMBER	MILITARY NOMENCLATURE	EQUIPMENT NAME AND CHARACTERISTICS	MANUFACTURER	TOTAL QUAN.	LOCATION AND QUANTITY	APPLICABLE PUBLICATIONS
DDR-5A (div)	AN/FRR-60(V)	Dual Diversity Radio Receiver, synthesized. 2 to 32 mcs., AM, CW, SSB. Power Requirement: 115 VAC, 60 cps, 1700 watts.	T. M. C.	9	RE3 - 6 RE4 - 3	Technical Manual for Dual Diversity Radio Receiver Model DDR-5A (AN/FRR-60(V))
DDR-5B	AN/FRR-60(V)	Non-Diversity SSB Radio Receiver, 2 to 32 mcs, SSB, ISB, AM, CW, MCW, FSK, FAX. Power Requirements 115/230 VAC, 48-62 cps, single phase, 1000 watts.	T. M. C.	1	RE4 - 1	Technical Manual for Diversity Radio Receiver Model DDR-5B
MSR-4	CV-591A/URR	Sideband Converter - Selects one of two sidebands of received signal. Input signal: 452-458 KC IF Output: 3 KC bandpass. Power Requirement: 115/230 Volts, 60 cps, 65 watts.	T. M. C.	6	RE2 - 3 RF3 - 3	Navships 93120
R-389/URR	R-389/URR	Radio Receiver. (LF-VLF) Power Requirement: 115/230 VAC, 60 cps, 250 watts.		5	RE3 - 4 RF2 - 1	
R-390A/URR	R-390A/URR	Radio Receiver. 0.5 to 32 mcs., CW, MCW, VOICE, SSB, FSK. Power Requirement: 115/230 VAC, 60 cps, 225 watts.		33	RE2 - 3 RE3 - 16 RE4 - 1 RF2 - 6 RF3 - 6 TC1 - 1	
R-5007/FRR-502	R-5007/FRR-502	Radio Receiver Sub-Assembly	T. M. C.	15	RE3 - 15	Technical Manual for Radio Receiver, R-5007
VLFC-1		Frequency Comparator.	T. M. C.	2	RE3 - 1 TC1 - 1	Technical Manual for Frequency Comparator Model VLFC-1
SBT-1K(V)	AN/URT-19(V)	Radio Transmitter (SSB), RF Output 1 KW. Power Requirement: 2.12 KW.	T. M. C.	10	TA3 - 10	Technical Manual for General Purpose Transmitters Model SBT-1K
TAB-7		Radio Transmitter, 2-KW RF Output 100-555KC. Power Requirement: 6.30 KW.	Westinghouse Electric Corp.	2	TE1 - 2	Instruction Book for Telegraph Transmitting Equipment
GPT-10K	AN/FRT-39D (AN/FRT-52)	Radio Transmitter, Gen. Purpose 2 to 28 mcs. synthesized. Power Requirement: 17.50 KW. Power Output: 10 KW (PEP)	T. M. C.	37	TA1 - 5 TA2 - 5 TA3 - 2 TB2 - 5 TB3 - 5 TC4 - 5 TD4 - 5 TG2 - 5	Technical Manual for Transmitting Set, Radio, Model GPT-10K
AN/FRT-19	AN/FRT-19	Radio Transmitter (Low Freq.) 15 KW. Power Requirement: 32 KW. 30-600 KC RATT-CW-FAX	Serria Electronics Corp.	1	TE1	Navships 92117
GPT-40KE	AN/FRT-40B (AN/FRT-54)	Radio Transmitter, Gen. Purpose RF Output 40 KW. 2 to 28 megacycles synthesized. SSB, ISB, AM, CW, FSK, & FAX. Power Requirement: 208V 3 ϕ , 60 cps, 72 KW.	T. M. C.	16	TB1 - 2 TC2 - 2 TC3 - 2 TD2 - 2 TD3 - 2 TG3 - 2 TH1 - 2 TH2 - 2	Technical Manual for Transmitting Set, Radio, Model GPT-40K

TABLE 1-4. AN/TSC-35 EQUIPMENT LIST (CONT)

MODEL NUMBER	MILITARY NOMENCLATURE	EQUIPMENT NAME AND CHARACTERISTICS	MANUFACTURER	TOTAL QUAN.	LOCATION AND QUANTITY	APPLICABLE PUBLICATIONS
AN/FRT-61	AN/FRT-61	Radio Transmitter (Low Freq.) RF output 50 KW. Power Requirement: 162 KW.	Continental Electronics	1	TH4 and TG4	
GPT-200K	AN/FRT-62	Radio Transmitter (SSB) RF Output: 200 KW Power Requirement: 400 KW	T. M. C.	1	TH3	Technical Manual for Transmitting Set, Radio, Model GPT-200K
TER-25KC-50U		Antenna Dissipator. Dummy Load for Transmitter, up to 25 KW RF Dissipation. Power Requirement: 115/230 Volts 150 watts.	T. M. C.	2	TD1 - 1 TG1 - 1	
TER-100-K/50U		Antenna Dissipator, Dummy Load for Transmitter, up to 100KW RF Dissipation. Power Requirement: 115/230 Volts. 700 Watts.	T. M. C.	1	TH3	Technical Manual for TER-100K/50U
AN/URR-27	AN/URR-27	Radio Receiver VHF. 95 to 195 mcs. VOICE, MCW. Power Requirement: 115 VAC, 60 cps, 110 watts.		2	RE2 - 2	
AN/URT-7	AN/URT-7	Radio Transmitter (VHF) 115 to 160 mcs.	Rauland-Borg Inc.	2	RE2 - 2	
AN/URR-35C	AN/URR-35C	Radio Receiver (UHF) 220 to 400 mcs. VOICE, MCW. Power Requirement: 115 VAC, 60 cps, 110 watts.		2	RE2 - 1 TC1 - 1	Navships 92676
AN/GRT-3	AN/GRT-3	Radio Transmitter (UHF) 225 to 399.9 mcs. (VOICE) RF Output: 100 watts. Power Requirement: 115/230 volts, 60 cps, 1.250 KW.		2	RE2 - 1 TC1 - 1	
AN/SRC-20	AN/SRC-20	Radio Set. Transceiver (UHF).	Collins Radio Co.	1	RE2 - 1	
74B1		Microwave Radio Set. Equipment Power Requirement: 600 watts.	Lenkurt Electric Co.	4	RE2 - 2 TC1 - 2	
AN/FCC-17	AN/FCC-17	Microwave Terminal, 60 Channel, Multiplex-Demultiplex Equipment. Power Requirement: 400 watts.	Lenkurt Electric Co.	2	RE2 - 1 TC1 - 1	
AN/FGC-59	AN/FGC-59	Torn Tape Relay Set (TTY) Power Requirement: Ea. TT-331/UG: 1.035 KW Ea. TT-332/UG: 1.345 KW Ea. TT-333/UG: 0.933 KW	Teletype Corp.	3	RA1 - 1 RJ1/RJ2-1 RF1 - 1	Universal Torn Tape Receiving Group, TT331/UG; Universal Torn Tape Monitor Group, TT332/UG; Universal Torn Tape Transmitter TT333/UG.
AN/FGC-73	AN/FGC-73	Multiple-Addressee TTY Processing System. Power Requirement: Ea. OA-4042/FGC-73: 1.260 KW Ea. C-4248/FGC-73: 0.180 KW Ea. TT-329/UG: 0.240 KW	Elgin Corp.	2	RA1 - 1 RJ1 - 1	Navships 94492
Model 28	AN/UGC-5	Model 28-ASR. Power Requirement: 130 watts.	Teletype Corp.	2	RF1 - 2	Automatic Send/Receive Set, Model 28

TABLE 1-4. AN/TSC-35 EQUIPMENT LIST (CONT)

MODEL NUMBER	MILITARY NOMENCLATURE	EQUIPMENT NAME AND CHARACTERISTICS	MANUFACTURER	TOTAL QUAN.	LOCATION AND QUANTITY	APPLICABLE PUBLICATIONS
Model 28	AN/UGC-6	Model 28 ASR. Power Requirement: 200 watts	Teletype Corp.	13	RA1 - 2 RA2 - 2 RA3 - 2 RA1 - 2 RF2 - 3 RJ2 - 2	Automatic Send/Receive Set, Model 28.
Model 28	AN/UGC-8	Model 28 - ASR (Weather.) Power Requirement: 200 watts	Teletype Corp.	4	RF2 - 4	Automatic Send/Receive Set, Weather Keyboard.
Model 28	TT-47/UG	Model 28 - Send/Receive (Floor Model) Power Requirement: 65 watts	Teletype Corp.	5	RA1 - 1 RA3 - 1 RF1 - 1 RF2 - 2	Send/Receive Set (Floor Mount) TT-47E/UG
Model 28	TT-171/UG	Model 28 Receive only. (Floor Model) Power Requirement: 65 watts.	Teletype Corp.	5	RA2 - 3 RA3 - 2	
Model 28	TT-176A/UG	Model 28 ("Skin Tight"). Send/Receive, (Rack-Mounted) Power Requirement: 65 watts.	Teletype Corp.	80	RA1 - 12 RB1 - 12 RB2 - 8 RB3 - 8 RC1 - 5 RE1 - 4 RE3 - 2 RF1 - 6 RF2 - 1 RJ1 - 20 TC1 - 2	Send/Receive Set (Rack Mount) TT-176A/UG
60/19	AN/FGC-60(V)	12 Channel Non-Diversity Telegraph Terminal System. Tone MUX-DEMUX Power Requirement: 400 watts.	Tele-Signal Corp.	1	RE1 - 1	60/19 System Description
60/22	AN/FGC-60(V)	16 Channel Non-Diversity, (60/22) Telegraph Terminal System. Tone MUX-DEMUX Power Requirement: 400 watts.	Tele-Signal Corp.	4	RE1 - 4	60/22 System Description
60/23A	AN/FGC-60(V)	24 Channel Telegraph Terminal System Tone, SEND. Power Requirement: 400 watts.	Tele-Signal Corp.	1	RE1 - 1	60/23 System Description
60/24	AN/FGC-60(V)	16 Channel Diversity, Telegraph terminal system. Tone MUX-DEMUX. Power Requirement: 400 watts.	Tele-Signal Corp.	8	RE1 - 8	Navships 93841
60/29	AN/FGC-60(V)	12 Channel Non-Diversity Telegraph Terminal System. Tone MUX-DEMUX. Power Requirement: 400 watts.	Tele-Signal Corp.	1	TC1 - 1	60/29 System Description
60/23B	AN/FGC-60(V)	24 Channel Telegraph Terminal System. Tone RECEIVE ONLY. Power Requirement: 400 watts.	Tele-Signal Corp.	1	TC1 - 1	60/23B System Description
AN/UGC-1A	AN/UGC-1A	Time Division Multiplexer Power Requirement: 86 watts.	Teletype Corp.	3	RC1 - 3	Navships 94376(A)
Model D-3		Demodulator	Page Comm.	24	RE3 - 24	Technical Manual, Model D3

TABLE 1-4. AN/TSC-35 EQUIPMENT LIST (CONT)

MODEL NUMBER	MILITARY NOMENCLATURE	EQUIPMENT NAME AND CHARACTERISTICS	MANUFACTURER	QUAN. TOTAL	LOCATION AND QUANTITY	APPLICABLE PUBLICATIONS
CFA-1	CV-763/URR	Frequency Shift Converter Power Requirement: 80 watts.	T. M. C.	1	RE3 - 1	Technical Manual, CFA-1
CFA-1LB		Frequency Shift Converter (Low Freq.) Power Requirement: 80 watts.	T. M. C.	3	RE3 - 3	Technical Manual, CFA-1(LB)
2067		RATT Tone Keyer, 500 cps SPACE and 700 cps MARK. (Transistorized version of an AN/SGC-1)	Tele-Signal Corp.	1	RE2 - 1	Model, 2067 Systems Description, Issue 1.
SPU-2		Speech Processing Unit Provides clipping and compression. Power Requirement: 115/230 Volts, 60 cps, 7 watts.	T. M. C.	6	RE2 - 2 RF3 - 3 TC1 - 1	Technical Manual, SPU-2
VT-2B	TA-401B	Telephone Terminal Set. 2W/4W Power Requirement: 30 watts.	Stelma, Inc.	5	RE2 - 5	Technical Manual for Voice Terminal Unit Stelma Model VT-2B
TMX-1	TD-410/UGC	Multiplexer, Voice Frequency, Providing two channels within one 6 kc passband. Power Requirement: 115 Volts AC, 60 cps, 4 watts.	T. M. C.	16	TC1 - 16	Technical Manual, TMX-1
RMX-1	TD-411/UGC	Demultiplexer, Voice Frequency (Companion unit to TD-410) Power Requirement: 115 Volts AC 60 cps, 4 watts.	T. M. C.	16	RE3 - 16	Technical Manual, RMX-1
Model 660A		Teleprinter to Morse Code Converter Power Requirement: 35 watts.	Frederick Electronics Corp.	2	RF2 - 2	Technical Description, Teleprinter to Morse Code Converter Model 660A
AN/UHX-2	AN/UHX-2	Facsimile Receiver, Continuous Page Recorder. Power Requirement: 275 watts.	Times Facsimile Corp.	1	RE4 - 1	Navships 93158 (A)
TT-321/UX	TT-321/UX	Facsimile Transceiver	Times Facsimile Corp.	1	RE4 - 1	Navships 91068A
CV-1066/UX	CV-1066/UX	Facsimile Converter		1	RE4 - 1	
MD-168/UX	MD-168/UX	Facsimile Modulator		1	RE4 - 1	
500AR		Recorder, (Playback Type). Power Requirement: 50 watts.	Broadcast Electronics, Inc.	1	RE2 - 1	Instruction Manual, Sptmaster 500A
300142		Dual Time Clock System, W/6 dual readouts and 2 single readouts. Power Requirement: 50 watts.	Elgin National Watch Co.	9 (Readout Units)	RA1 - 1 RB1 - 1 RB3 - 1 RC1 - 1 RE1 - 1 RE3 - 1 RF1 - 1 RF2 - 1 RJ1 - 1	Instruction Manual, Dual Time Clock System.

TABLE 1-4. AN/TSC-35 EQUIPMENT LIST (CONT)

MODEL NUMBER	MILITARY NOMENCLATURE	EQUIPMENT NAME AND CHARACTERISTICS	MANUFACTURER	TOTAL QUAN.	LOCATION AND QUANTITY	APPLICABLE PUBLICATIONS
MS2312-LLS		Intercommunications Station, 10 Channel (All Master Type), Power Requirement: 4 watts.	Voycall	22	RA1 - 1 RA2 - 1 RA3 - 2 RB1 - 2 RC1 - 1 RD1 - 1 RE1 - 1 RE2 - 1 RE3 - 1 RF1 - 2 RF2 - 1 RG1 - 2 RH1 - 1 RJ1 - 1 GR2 - 1 TC1 - 1 GT2 - 1 RB2 - 2	Manual of Installation Instruction, Operating Instructions, Schematic Drawings 2200LL-2300LL-2400LL-2500LL Series Master Stations Voycall Intercommunicating Equipment.
DA-20		Amplifier, Audio, 20 Channel	Dixon-Laboratories, Inc.	2	RB1 - 1 RE1 - 1	Instruction Manual, DA-20
6002-1		Modulator (keyer). Converts DC keying to 10-kc Phase Shifted Tone. Power Requirement: 7 watts.	Robertshaw-Fulton	635	All at rec. site	Instruction Manual, Multilock 6002 Converter (Modulator - 6002-1) (Demodulator - 6002-2)
6002-2		Demodulator (Converter). Converts 10-KC Phase Shifted Tone to DC Keying Signal. Power Requirement: 10 Watts.	Robertshaw-Fulton	688	All at rec. site	Instruction Manual, Multilock 6002-2 Converter. (Modulator 6002-1) (Demodulator 6002-2)
6004-1		Control Keyer. Converts DC Keying Signals to Frequency Shift Carrier Signal. Power Requirement: 5 watts.	Robertshaw-Fulton	100	All at rec. site	Operation and Maintenance Manual, Multilock Control Keyer Model 6004
6004-2		Control Demodulator. Converts Frequency Shift Carrier Signal provided by 6004-1 to DC Keying. Power Requirement: 10 watts.	Robertshaw-Fulton	92	All at rec. site	Operation and Maintenance Manual, Multilock Control Keyer Model 6004
6006		Loop Supply, 20 or 60 ma.	Robertshaw-Fulton	390	All at rec. site	Instruction Manual, Telegraph Loop Supply 6006.
	AN/GGA-1	Cryptographic		2	RA2 - 2	
	TSEC/KW-7	Cryptographic	Raytheon	3	RB2 - 3	
	TSEC/HW-10	Cryptographic	Teletype Corp.	2	RA2 - 2	KAM-7/TSEC
	TSEC/HW-19	Cryptographic		2	RA2 - 2	KAM-40/TSEC
	TSEC/KG-14	Cryptographic		4	RB1 - 4	
	TSEC/KW-22	Cryptographic		3	RC1 - 3	
	TSEC/KW-26C	Cryptographic	Burroughs Corp.	64	RA3 - 1 RB2 - 28 RB3 - 35	

TABLE 1-4. AN/TSC-35 EQUIPMENT LIST (CONT)

MODEL NUMBER	MILITARY NOMENCLATURE	EQUIPMENT NAME AND CHARACTERISTICS	MANUFACTURER	TOTAL QUAN.	LOCATION AND QUANTITY	APPLICABLE PUBLICATIONS
	TSEC/KW-37	Cryptographic		4	RB1 - 4	
CU-656/U	CU-656/U	Antenna Multicoupler. One input to eight outputs. Power Requirement: 115/230 Volts, 60 cps.	Westinghouse Electric Corp.	18	RA3 - 3 RE4 - 15	Navships 93804 (A)
LFD-1		Antenna Multicoupler (L. F. Passive). One Input to Three Outputs.	T. M. C.	1	RE4 - 1	
SPP-30416		R. F. Patch Panel	T. M. C.	5	TC1 - 5	
SPP-40416		R. F. Patch Panel	T. M. C.	12	RA3 - 2 RE4 - 10	
775		Antenna Control Unit, Model 775	Granger Assoc.	1	TH3	Instruction Manual, Antenna Control System, Model 775
143A1		Antenna Control Unit, RLPA	Collins Radio Co.	16	RE3 - 6 TC1 - 10	
27935		Transmitting Antenna Patch Field.	Andrews Corp.	8	TD1 - 4 TG1 - 4	
TCI-0249		Transmitter Alarm Panel.	T. M. C.	5	TC1 - 5	
30570		4 x 1 Dummy Load Patch Panel.	Andrews Corp.	2	TD1 - 1 TG1 - 1	Andrews Bulletin No. 17896
DELCO Y1-4856-MZ		Diesel-Driven Generator, 335 kilowatts 208 VAC 60 cps, 3 ϕ , 60 cps.	T. M. C. Power	18	GR3 - 3 GR6 - 3 GT3 - 3 GT4 - 3 GT5 - 3 GT6 - 3	Transportable Communication System SYM-2005 (AN/TSC-35) Primary Power System
FU-593/G		No-Break Power Generator, 200KW Delivers 200 KW, 208 VAC, 3 ϕ , 60 cps.	T. M. C. Power	2	GR4 - 1 GR5 - 1	Oper. and Maint. Inst. for Model PFS 200 PNB "NO BREAK" Electric Power System.
MAC-10-S12		Air Conditioner (5 Ton) Power Requirement: 12.6 KW.	Air-Flow	79	See Table 1-2	Operation Maintenance and Service Instructions, Handbook 331
1910B		Dehydrator Unit, (D-5550-5)	Dielectric Products	3	TD1 - 1 TG1 - 1 TH3 - 1	Heatless Dehydrator Outline and Schematics, D-5500-5
59060		Dehydrator Unit (Low Pressure Type)	Dielectric Products	1	RE2	Heatless Dehydrator Outline and Schematics, Model 59060
1825A		Sonic Cleaner, consisting of: 1 ea. Cleaner, SEC1825A, 1 ea. Rinse, SR-1825A, 1 ea. Dryer SD1825A. Power Requirement: 16.230 KW.	Bendix	1	RH1 - 1	
DAC-V	AN/GGM-1	Teletype Distortion Analyzer, Power Requirement: 100 watts.	Stelma	2	RB1 - 1 RE1 - 1	TM-11-6625-422-12

TABLE 1-4. AN/TSC-35 EQUIPMENT LIST (CONT)

MODEL NUMBER	MILITARY NOMENCLATURE	EQUIPMENT NAME AND CHARACTERISTICS	MANUFACTURER	TOTAL QUAN.	LOCATION AND QUANTITY	APPLICABLE PUBLICATIONS
PTE-3	AN/GRM-33A	Spectrum Analyzer	T. M. C.	3	RE1 - 1 TC1 - 2	
DT-103B		Word Generator (TTY)	Digitech, Inc.	2	RH1 - 2	
DT-104		Character Generator (TTY)	Digitech, Inc.	2	RH1 - 1 TF1 - 1	
DT-603		Telegraph Signal Analyzer (TTY) Power Requirement: 115 Volts AC, 60 cps, 9 watts.	Digitech, Inc.	2	RH1 - 2	
LA-80B		EPUT Meter. Frequency Counter. Power Requirement: 115/230 Volts, 50 to 400 cps, 600 watts.	Lavoie, Inc.	6	RA2 - 2 RD1 - 2 TF1 - 2	
LA-915A		Converter used with LA-80B for 10 to 100 mc. capability.	Lavoie, Inc.	3	RA2 - 1 RD1 - 1 TF1 - 1	
LP-1A		Sonic Analyzer (Panoramic)	Panoramic	1	RE1 - 1	
NF-105		Field Intensity Meter.	Empire Devices Inc.	1	RD1 - 1	
SG-25		Signal Generator		4	RD1 - 2 TF1 - 2	
SG-1000		Megger	Winslow-Elec- tronics, Inc.	2	RD1 - 1 TF1 - 1	
ZM-11/U	ZM-11/U	Impedance Bridge, Power Require- ment: 115 Volts AC 40 watts.		3	RA2 - 1 RD1 - 1 TE1 - 1	
2-16		Impedance Bridge	Alpha Corp.	3	RA2 - 1 RD1 - 1 TF1 - 1	
200 CD		Test Oscillator, 5 cps to 600 kcs. Delivers 10 volts into 600 ohms. Power Requirement: 115/230 volts, 60 cps, 75 watts.	Hewlett- Packard	3	RD1 - 2 TF1 - 1	Wide range Oscillator, Model HP-200CD
200 CDR		Oscillator Rack-Mount 5 to 600 cps, Power Requirement: 115/230 Volts, 60 cps, 75 watts.	Hewlett- Packard	1	RD1 - 1	
260A		Q Meter. Power Requirement: 115 Volts AC, 60 cps, 65 watts.	Boonton, Inc.	1	TF1 - 1	
260 (Series III)		Volt-Ohm-Milliampere Meter	Simpson Electric Co.	18	RA2 - 3 RD1 - 6 RH1 - 3 TF1 - 6	Simpson Volt-Ohm- Milliammeter Model 260
270		Volt-Ohm- Milliampere Meter	Simpson Electric Co.	1	RA3 - 1	Simpson Volt-Ohm- Milliampere Meter Model 270

TABLE 1-4. AN/TSC-35 EQUIPMENT LIST (CONT)

MODEL NUMBER	MILITARY NOMENCLATURE	EQUIPMENT NAME AND CHARACTERISTICS	MANUFACTURER	TOTAL QUAN.	LOCATION AND QUANTITY	APPLICABLE PUBLICATIONS
304A		Oscilloscope, General Purpose, Power Requirement: 115/230 Volts, 60 cps, 110 watts.	Dumont, Inc.	4	RD1 - 2 TF1 - 2	
304AR		Oscilloscope Power Requirement: 115/230 Volts, 60 cps, 110 watts.	Dumont, Inc.	2	RD1 - 1 TF1 - 1	
400D		VTVM Power Requirement: 100/220 Volts, 60 cps, 100 watts.	Hewlett-Packard	5	RA2 - 1 RD1 - 2 TF1 - 2	
410B		VTVM Power Requirement: 115/230 Volts, 60 cps., 65 watts.	Hewlett-Packard	8	RA2 - 2 RD1 - 3 TF1 - 3	
535A		Oscilloscope with dual-trace plug-in Preamplifier, Type CA. Power Requirement: 500 watts.	Tektronix, Inc.	6	RA2 - 2 RD1 - 2 TF1 - 2	
738 AR		Voltmeter Calibrator Power Requirement: 115/230 Volts, 60 cps., 380 watts.	Hewlett-Packard	1	RD1 - 1	
751		Transmission Line Fault Locator, Power Requirement: 115 Volt: AC to 400 cps., 100 watts.	Radar Engineering Inc.	1	TF1 - 1	
752A		Vacuum Tube Tester	Hickock	5	RA2 - 1 RA3 - 1 RD1 - 1 RH1 - 1 TF1 - 1	
916AL		RF Bridge	General Radio	1	TF1 - 1	
1606A		RF Bridge	General Radio	1	TF1 - 1	
1890M		Transistor Test Set, Portable, Battery Operated.	Hickock Instr. Co.	3	RA2 - 1 RD1 - 1 TF1 - 1	
4514		Relay Test Set. Power Requirement: 115 Volts AC, 60 cps, 35 watts.	Sigma Corp.	1	RA2 - 1	
8150B		EPUT Counter Power Requirement: 115 Volts AC, 60 cps, 400 watts.	Beckman/Berkeley	2	RD1 - 1 TF1 - 1	
90651		Grid Dip Meter., 1.7 to 300 mcs.	Miller, Inc.	2	RD1 - 1 TF1 - 1	
185A-500-FN		Average-Reading Termination Wattmeter.	Sierra Instrument Company	2	RD1 - 1 TE1 - 1	
O-450/U		Oscillator, Audio	Hewlett-Packard	1	RE1 - 1	

TABLE 1-4. AN/TSC-35 EQUIPMENT LIST (CONT)

MODEL NUMBER	MILITARY NOMENCLATURE	EQUIPMENT NAME AND CHARACTERISTICS	MANUFACTURER	TOTAL QUAN.	LOCATION AND QUANTITY	APPLICABLE PUBLICATIONS
606A		Signal Generator, (H. F.)	Hewlett-Packard	1	RA3 - 1	
524D		Frequency Counter	Hewlett-Packard	1	RA3 - 1	
525A		Frequency Converter	Hewlett-Packard	1	RA3 - 1	
335A		Precision Attenuator	Hewlett-Packard	1	RA3 - 1	
335B		Precision Attenuator	Hewlett-Packard	1	RA3 - 1	
254D		Voltage Standard (H. F.)	Boonton	1	RA3 - 1	
314		Voltmeter (R. F.)	Ballantine Lab., Inc.	1	RA3 - 1	
526B		Time Interval Unit	Hewlett-Packard	1	RA3 - 1	
211A		Square Wave Generator	Hewlett-Packard	1	RA3 - 1	
WV-98C		Voltohmmist (Senior W/Probe WC-301A	R. C. A.	1	RA3 - 1	
180		Time-Mark Generator	Tektronix Corp.	1	RA3 - 1	
541A		Oscillator, W/Dual-Trace Preamplifier, Type CA.	Tektronix Corp.	1	RA3 - 1	
107		Square Wave Generator	Tektronix Corp.	1	RA3 - 1	
1750A		Sweep Drive	General Radio Co.	1	RA3 - 1	
W10MT		Variac (Auto-Transformer)	General Radio Co.	1	RA3 - 1	
100		Voltage Calibrator	Exact Electronics Inc.	1	RA3 - 1	
500A		Scopemobile	Tektronix Corp.	4	RA2 - 1 RA3 - 1 RD1 - 1 TF1 - 1	
161		Service Cart	Equipto	12	RA2 - 3 RD1 - 3 TH1 - 3 TF1 - 3	

TABLE 1-5. PORTABLE TOOL KIT

QUANTITY	TOOL DESCRIPTION
1	Tool Box, Union #5414
1	Soldering Gun, Weller #D-440
1	Screwdriver, 3/32" X 3" Blade, Xcelite #R-3323SS
1	Screwdriver, 1/8" X 8" Blade, Xcelite #R-188
1	Screwdriver, 3/16" X 4" Blade, Xcelite #S-3164
1	Screwdriver, 1/4" X 8" Blade, Xcelite #R-148
1	Screwdriver, #1 X 6" Blade, Xcelite #X-108
1	Screwdriver, #2 X 4" Blade, Xcelite #X-102
1	Narrow Head Diagonal Cutters, 6", Kraeuter #CG-4501
1	Chain Nose Pliers, 7", Kraeuter #CG-1771
1	Combination Pliers, 6", Kraeuter #056
1	Lock Wrench Pliers, 10", Vice Grip, #10DC
1	Electricians Knife, Kelin-1550-2

QUANTITY	TOOL DESCRIPTION
1	Adjustable Wrench, 6", Proto #706L
1	Box & Open Wrench Set, Proto #1200L
1	Alignment Tool Kit, GC #8280
1	Soldering Aid, GC #9088
1	Soldering Aid, GC #9093
1	Tube Puller, GC #5092
1	Tube Pin Straightener, GC #8655
1	Tweezer Kit, GC #7950
1	Wire Stripper, Miller #101-S
1	Electricians Scissors, Clauss #4217
1	Tape Rule, Lufkin #W7212
1	Screwdriver, Screwholding 5/16 X 8" Hold-E-Zee #TH-8
1	Offset Screwdriver, Phillips Head, General Hardware #807X
1	Offset Screwdriver, Standard Head, General Hardware #807
1	Allen & Bristol Wrench Kit, Allied Catalog #45N166
1	Flashlights, Eveready #2251

TABLE 1-6. ELECTRONIC WORK BENCH KIT

QUANTITY	TOOL DESCRIPTION
1	Soldering Gun, Weller #D-440
1	Soldering Iron Handle Ungar #776
1	Soldering Iron Heating Element, Ungar #4045
1	Soldering Iron Tiptet, Ungar PL-824
1	Soldering Iron Holder, Ungar #8000
1	Soldering Iron Cleaning Pads, Ungar #400
1	Desoldering Kits, Ungar #270
1	1/16" Nutdriver, Xcelite #HS-6
1	1/4" Nutdriver Xcelite #HS-8
1	5/16" Nutdriver, Xcelite #HS-10
1	11/32" Nutdriver, Xcelite #HS-11
1	3/8" Nutdriver, Xcelite #HS-12
1	7/16" Nutdriver, Xcelite #HS-14
1	1/2" Nutdriver, Xcelite #HS-16
1	9/16" Nutdriver, Xcelite #HS-18
1	5/8" Nutdriver, Xcelite #HS-20
1	Screwdriver, 3/32" X 3" Blade, Xcelite #R-3323SS
1	Screwdriver, 1/8" X 8" Blade, Xcelite #R-188
1	Screwdriver, 3/16" X 4" Blade, Xcelite #S3164
1	Screwdriver, 1/4" X 8" Blade, Xcelite #R-148
1	Screwdriver, 1/4" X 1", Xcelite #S-141

QUANTITY	TOOL DESCRIPTION
1	Screwdriver, #1" X 1-3/8" Blade, Xcelite #SX-101
1	Screwdriver, #2 X 1-3/8" Blade, Xcelite #SX-102
1	Screwdriver, #0 X 2" Blade, Xcelite #P-12S
1	Screwdriver, #1 X 6" Blade, Xcelite #X-108
1	Screwdriver, #2 X 4" Blade, Xcelite #X-102
1	Screwdriver, #3 X 6" Blade, Xcelite #X-103
1	Side Cutting Pliers, 60-1/2", Kraeuter #CG-1830
1	End Cutting Nippers, 6", Kraeuter #CG-3850
1	Narrow Head Diagonal Cutters, 6", Kraeuter #CG-4501
1	Diagonal Cutters, 4-1/2", Kraeuter #CG-81
1	Chain Nose Pliers, 7", Kraeuter #CG-1771
1	Long reach short jaw nose pliers, 8" Kraeuter #CG-61
1	Combination Pliers, 6", Kraeuter #056
1	Slip Joint Pliers, 10", Kraeuter #CG-710
1	Lock Wrench Pliers, 10", Vice Grip, #10DC
1	Electricians Knife, Kelin-1550-2
1	Adjustable Wrench, 6", Proto #706L
1	Adjustable Wrench, 8", Proto #708L
1	Box & open Wrench Set, Proto #1200L
1	Soft Face Hammer, Proto #1362
1	Socket Set, 1/4" Drive, Proto #4700B

TABLE 1-6. ELECTRONIC WORK BENCH KIT (CONT)

QUANTITY	TOOL DESCRIPTION
1	Alignment Tool Kit, GC #9200
1	Soldering Aid, GC #9088
1	Soldering Aid, GC #9093
1	Inspection Mirror, GC #5090
1	Tube Puller, GC #5092
1	Tube Pin Straightener, GC #8655
1	Tweezer Kit, GC #7950
2	Tool Caddies, GC #9525
1	Jewelers Screwdriver Set, General Hardware
1	Wire Stripper, Miller #101-S
1	Electricians Scissors, Clauss #4217
1	Tape Rule, Lufkin #W7212

QUANTITY	TOOL DESCRIPTION
1	Vise and Positioner, Wilton #364
1	Screwdriver, Screwholding 5/30" X 6" Hold-E-Zee #TR-6
1	Screwdriver, Screwholding 5/16" X 8" Hold-E-Zee #TH-8
1	Screwdriver, Screwholding 7/32" X 1-3/4" Hold-E-Zee #TC-2
1	Offset Screwdriver, Phillips Head, General Hardware #807X
1	Offset Screwdriver, Standard Head, General Hardware #807
1	Allen & Bristol Wrench Kit, Allied Catalog #45N166
1	Crimping Tool, AMP #47100-1
1	Flashlights, Eveready #2251

TABLE 1-7. ANTENNA FIELD TOOL KITS

QUANTITY	TOOL DESCRIPTION
2	Tool Box, Union #5414
1	Long Reach Short Jaw nose pliers 8" Kraeuter #CG-61
1	End Cutting Nippers, 8", Kraeuter #CG-3850
1	Combination Pliers, 8", Kraeuter #056
1	Combination Pliers, 10", Kraeuter #056
1	Tongue-N-Groove Joint Pliers, 10", Kraeuter #CG-710
1	Linemans Pliers, 8-1/2", Kraeuter #CG-1801
1	Heavy duty diagonal cutters, 7", Kraeuter #CG-4610
1	Electricians Knife, Kelin-1550-2
1	Adjustable Wrench, 8", Proto #708L
1	Adjustable Wrench, 10", Proto #710L
1	Adjustable Wrench, 12", Proto #712L

QUANTITY	TOOL DESCRIPTION
1	Box & Open Wrench Set, Proto #1200F
1	Soft Face Hammer, Proto #1362
1	Ball Peen Hammer, Proto #1308P
1	Ball Peen Hammer, Proto #1324P
1	Socket Set, 1/2" Drive, Proto #54000C
2	Pipe Wrench, 1/4", Proto #814HD
2	Pipe Wrench, 24", Proto #824HD
1	Metal Snips, Proto #303S
1	Hacksaw Frame, Proto #352
1	Punch & Chisel Set, Proto #2
1	Screwdriver, Set, Proto #9800A
1	High Speed Wood Bits, Greenlee #33M-11
1	High Speed Drill Bit Set, 1/16" - 1/2" in 32nd. s, Cleveland #6

TABLE 1-7. ANTENNA FIELD TOOL KITS (CONT)

QUANTITY	TOOL DESCRIPTION
1	Drill Bit Holder, Cleveland #415
1	Wire Wheel Brush, Fine, Black & Decker #39008
1	Wire Wheel Brush, Course, Black & Decker #39009
1	1/4" Drill Arbor, Black & Decker #39026
1	Flat File, 10" Bastard Cut, Nicholson
1	Flat File, 10", Second Cut, Nicholson
1	Flat File, 10", Smooth Cut, Nicholson
1	Round File, Bastard Cut, Nicholson
4	File Handles, #2, Nicholson #2
1	File Brushes, Nicholson
1	Hacksaw Blades, 18 teeth, 12" Miller Falls #BF1218
1	Hacksaw Blades, 24 teeth, 12" Millers Falls #BF1224
1	Hacksaw Blades, 32 teeth, 12" Millers Falls #BF1232
1	Propane Gas Torch Kit, Benz-O-Matic
1	5-1 Speed Reducer, Babco #825
10	Sanding Disk Sets, Babco #509
1	Sander Kit, Babco #30
1	Hand Drill, Miller Falls #1425
2	Vice Grip Pliers, 10", Vice Grip #10R
5 lbs.	Multicore Solder, 16 guage, Ersin
1	Power Pack, 3/8" Drill, Skil #468
1	Power Pack, Skil #24981

QUANTITY	TOOL DESCRIPTION
1	Charger, Skil #25967
1	4 ft. cord, Skil #25882
1	25 ft. cord, Skil #25970
2	Sledge Hammers, 10 lbs., Warren Teed #84H
2	Wedge Point Crowbars, 10 lbs., Warren Teed #40
2	Pick-Mattock, 5 lbs., Warren Teed #20
2	Carpenters Wrecking Bar, 3/4" X 36", Warren Teed #45
1	Drill and Wire Guages, Allied Catalog #46N060, GH.
1	Steel Tape, 100ft., Lufkin #C-256, Graybar
2	Standard "D" Tool Belt, Klein #5204-L, Graybar
2	Leather Safety Strap, Klien #KL-525, Graybar
2	Pole Master Climber, Klien #C-1945A
2	"Chicago" Grips, Klien #1613-40B, Graybar
2	Wood Tackle Blocks, Single 3/8", B&L Star, #3001A Graybar
2	Wood Tackle Blocks, Double 3/8", B&L Star #3002A, Graybar
2	Coffing Mighty Midget Puller, Coffing #MP-10 Graybar
2	Leather Gloves, Salisbury #122C
2	Sound Powdered Phones, U. S. Instru. #A560, Graybar
1	Rubber Knee Boots, Size 8
1	Rubber Knee Boots, Size 9
1	Rubber Knee Boots, Size 10
1	Rubber Knee Boots, Size 11
1	Rubber Knee Boots, Size 12

TABLE 1-8. HEAVY DUTY WORK BENCH KIT

QUANTITY	TOOL DESCRIPTION
1	End Cutting Nippers, 8", Kraeuter #CG-3850
1	Combination Pliers, 8", Kraeuter #056
1	Combination Pliers, 10", Kraeuter #056
1	Tongue-N-Groove Joint Pliers, 10", Kraeuter #CG-710
1	Electricians Knife, Kelin-1550-2
1	Adjustable Wrench, 8", Proto #708L
1	Adjustable Wrench, 10", Proto #710L
1	Adjustable Wrench, 12", Proto #712L
1	Box & Open Wrench Set, Proto #1200F
1	Soft Face Hammer, Proto #1362
1	Ball Peen Hammer, Proto #1308P
1	Ball Peen Hammer, Proto #1324P
1	Socket Set, 1/2" Drive, Proto #54000C
1	Socket Set, 1/4" Drive, Proto #4700C
1	Pipe Wrench, 1/4", Proto #814HD
1	Metal Snips, Proto #303S
1	Tin Snips, Proto #322
1	Hacksaw Frame, Proto #352
3	C Clamps, Proto #403
2	C Clamps, Proto #408
1	Punch & Chisel Set, Proto #2
1	Screwdriver, Set, Proto #9800A
1	High Speed Wood Bits, Greenlee #33M-11
1	Chassis Punch, 1/2" Greenlee #730

QUANTITY	TOOL DESCRIPTION
1	Chassis Punch, 9/16", Greenlee #730
1	Chassis Punch, 5/8", Greenlee #730
1	Chassis Punch, 11/16", Greenlee #730
1	Chassis Punch, 3/4", Greenlee #730
1	Chassis Punch, 13/16", Greenlee #730
1	Chassis Punch, 7/8", Greenlee #730
1	Chassis Punch, 15/16", Greenlee #730
1	Chassis Punch, 1", Greenlee #730
1	Chassis Punch, 1-1/16", Greenlee #730
1	Chassis Punch, 1-1/8", Greenlee #730
1	Multi-Speed Saber Saw Kit, Sears Roebuck #9A2772
2	High Speed Drill Bit Set, Cleveland #8
2	Drill Bit Holder, Cleveland #460
2	High Speed Drill Bit Set, 1/16" - 1/2" in 32nd. s, Cleveland #6
2	Drill Bit Holder, Cleveland #415
1	Electric Drill, 1/4", Black & Decker #345
1	Scrudrill, 3/8", Black & Decker #681
1	Screwdriver Bit, Black & Decker #13207
1	1/4" Socker Wrench Shank, Black & Decker #20510
1	Bit and Finder, Black & Decker #46098
1	1/4" Socket Wrench Shank, Black & Decker #20511

TABLE 1-8. HEAVY DUTY WORK BENCH KIT (CONT)

QUANTITY	TOOL DESCRIPTION
1	Phillips Headbit #1, Black & Decker #17922
1	Phillips Headbit #2, Black & Decker #18098
1	Phillips Headbit #3, Black & Decker #21366
1	Right Angle Drilling Attachment, Black & Decker #49348
1	Wire Wheel Brush, Fine, Black & Decker #39008
1	Wire Wheel Brush, Course, Black & Decker #39009
1	1/4" Drill Arbor, Black & Decker #39026
1	1/4" Sanding Pad Arbor, Black & Decker #23041
1	1/4" Sanding Pad Black & Decker #50829
1	Flat File, 10" Bastard Cut, Nicholson
1	Flat File, 10" Second Cut, Nicholson
1	Flat File, 10" Smooth Cut, Nicholson
1	Taper File, Slim, 10", Nicholson
1	Round File, 6", Second Cut, Nicholson
1	Round File, Bastard Cut, Nicholson
6	File Handles, #2, Nicholson #2
2	File Brushes, Nicholson
1	Set 12 assorted Needle Files, Simonds 2nd. Cut
1	Combination, Square 12", Lofkin #25C
1 Doz.	Hacksaw Blades, 18 teeth, 12" Millers Falls #BF1218

QUANTITY	TOOL DESCRIPTION
1 Doz.	Hacksaw Blades, 24 teeth, 12" Millers Falls #BF1224
1 Doz.	Hacksaw Blades, 32 teeth, 12" Millers Falls #BF1232
1	Drill Press Vise, Palmgreen #000
1	Propane Gas Torch Kit, Benz-O-Matic
1	Moto-Tool Kit, Dremel #2
1	5-1 Speed Reducer, Babco #825
10	Sanding Disk Sets, Babco #509
1	Hand Drill, Müller Falls #1425
1	Counter Sink, 1/2", Miller Falls #710
1	Counter Sink, 3/4", Miller Falls #710
1	Wood Chisel Set, Miller Falls #1434
1	Drill Bit Grinder, General Hardware #825
1	Circle Cutter, 1" to 6" hole, round shank 1/2", General Hardware, Allied Catalog - #45N350
5	Blades for Circle Cutter, General Hardware
1	Metal Nibbling Tool, Adel
2	Replacement Punches for Nibbling Tool, Adel
1	Tap and Die Set, Henry Hanson #21
2	Vice Grip Pliers, 10", Vice Grip #10R
1	Vice Grip Pliers, C Clamp, Vice Grip #11R
2	Vice Grip Pliers, Sheetmetal, Vice Grip #8R
1	Drill and Wire Guages, Allied Catalog #46N060, GH.
2	9" Scriber, Allied Catalog #50N309

TABLE 1-9. MISCELLANEOUS MAINTENANCE MATERIAL

QUANTITY		DESCRIPTION
RECEIVER SITE	TRANSMITTER SITE	
40	20	Soldering Gun Tips, Weller #7135
6	4	Soldering Iron Heating Element, Ungar #4045
12	8	Soldering Iron Tiptet, Ungar PL-824
16	4	Soldering Iron Cleaning Pads, Ungar #400
3	1	Refill sponges for cleaning pad, Ungar #455
3	1	Cans heat seal, Ungar #G801
3	1	Cans Anti-seize compound, Ungar
1	1	Radio and Speaker Cement, GC #30-8
1	1	Bakelite Cement, GC #32-2
1	1	All purpose plastic cement, GC #32-2A
1	1	Red Glyptal, GC #90-8
5	5	Insulating Spray Insl-X, GC #E26
10	10	Spra-Kleen Contact Cleaner, GC
30	10	Banana Plugs, Red, GC #33-006
30	10	Banana Plugs, Black, GC #33-008
30	10	Banana Plugs, Red, GC #33-128
30	10	Banana Plugs, Black, GC #33-130
20	20	Propane, Replacement Fuel Tanks, Benz-O-Matic
15 lbs	5 lbs.	Multicore Solder, 18 Guage, Ersin
1	1	Dymo Tape Writer, Dymo #M22
3	3	Dymo Tape, Red, Dymo #158-2
3	3	Dymo Tape, Orange, Dymo #158-4
3	3	Dymo Tape, Green, Dymo #158-5
3	3	Dymo Tape, Blue, Dymo #158-6
3	3	Dymo Tape, Brown, Dymo #158-8
3	3	Dymo Tape, Black, Dymo #158-9
5	5	Acetate Write-on-it Tape, Labelon #415
15	5	Spray Paint, Dove Gray, Krylon
70	30	Alligator Clips, Red, Mueller #60CHS

TABLE 1-9. MISCELLANEOUS MAINTENANCE MATERIAL (CONT)

QUANTITY		DESCRIPTION
RECEIVER SITE	TRANSMITTER SITE	
70	30	Alligator Clips, Black, Mueller #60CHS
3	1	Braided Nylon Lacing Tape, 500 yds. Alpha #LC-136
150 ft.	50 ft.	Plastic Tubing, Clear, Alpha, Allied Catalog #71TT313
150 ft.	50 ft.	Spiral Cable Wrapping Sheath, Panduit #T-25F
350	150	Hollow Wall Fasteners, Rawl-20-112
1 rolls	1 rolls	100 ft. rolls, Thermoplastic Hook-up Wire, #20 Stranded Stranded, Black, Belden #8523
1 rolls	1 rolls	100 ft. rolls, Thermoplastic Hook-up Wire, #20 Stranded, Brown, Belden #8523
1 rolls	1 rolls	100 ft. rolls, Thermoplastic Hook-up Wire, #20 Stranded, Red, Belden #8523
1 rolls	1 rolls	100 ft. rolls, Thermoplastic Hook-up Wire, #20 Stranded, Orange, Belden #8523
1 rolls	1 rolls	100 ft. rolls, Thermoplastic Hook-up Wire, #20 Stranded, Yellow, Belden #8523
1 rolls	1 rolls	100 ft. rolls, Thermoplastic Hook-up Wire, #20 Stranded, Green, Belden #8523
1 rolls	1 rolls	100 ft. rolls, Thermoplastic Hook-up Wire, #20 Stranded, Blue, Belden 38523
1 rolls	1 rolls	100 ft. rolls, Thermoplastic Hook-up Wire, #20 Stranded, Violet, Belden #8523
1 rolls	1 rolls	100 ft. rolls, Thermoplastic Hook-up Wire, #20 Stranded, Grey, Belden #8523
1 rolls	1 rolls	100 ft. rolls, Thermoplastic Hook-up Wire, #20 Stranded, White, Belden #8523
1	1	Test Prod. Wire, Red, 500 ft., Belden #8899
1	1	Test Prod. Wire, Black, 500 ft., Belden #8899
30	10	Vinal Electrical Tape, 3/4" Scotch
1 gross	1 gross	Brass Bolts, 1/2" 4/40
1 gross	1 gross	Brass Bolts, 3/8" 6/32
1 gross	1 gross	Brass Bolts, 3/4" 6/32
1 gross	1 gross	Brass Bolts, 1-1/4" 6/32
1 gross	1 gross	Brass Bolts, 1/2" 8/32
1 gross	1 gross	Brass Bolts, 1" 8/32
1 gross	1 gross	Brass Bolts, 1/2" 10/32

TABLE 1-9. MISCELLANEOUS MAINTENANCE MATERIAL (CONT)

QUANTITY		DESCRIPTION
RECEIVER SITE	TRANSMITTER SITE	
1 gross	1 gross	Brass Bolts, 1" 10/32
1 gross	1 gross	Brass Bolts, 1" 12/24
1 gross	1 gross	Brass Bolts, 1" 1/4/20
1 gross	1 gross	Brass Nuts 4/40
1 gross	1 gross	Brass Nuts 6/32
1 gross	1 gross	Brass Nuts 8/32
1 gross	1 gross	Brass Nuts 10/32
1 gross	1 gross	Brass Nuts 12/24
1 gross	1 gross	Brass Nuts 1/4/20
1 gross	1 gross	Star Lockwashers #4
1 gross	1 gross	Star Lockwashers #6
1 gross	1 gross	Star Lockwashers #8
1 gross	1 gross	Star Lockwashers #10
1 gross	1 gross	Star Lockwashers #12
1 gross	1 gross	Star Lockwashers #1/4"
1 gross	1 gross	Sheetmetal Screws #6 X 3/8"
1 gross	1 gross	Sheetmetal Screws #6 X 3/4"
1 gross	1 gross	Sheetmetal Screws #8 X 3/8"
1 gross	1 gross	Sheetmetal Screws #8 X 3/4"
1 gross	1 gross	Sheetmetal Screws #10 X 1/2"
1 gross	1 gross	Wood Screws, #8 X 1"
1 gross	1 gross	Wood Screws #10 X 1-1/4"
300	100	Insulated Solderless Lugs, AMP #34165
300	100	Insulated Solderless Lugs, AMP #34167
300	100	Insulated Solderless Lugs, AMP #34071
300	100	Insulated Solderless Lugs, AMP #34070
400	200	Insulated Solderless Lugs, AMP #34154
1	1	Flat Fish Tape, 100 ft., Ideal #31-009, Graybar
1	1	Floor Buffer, TR 13E, Premier
3	1	Hand Type Cleaner, Ideal #22-163, Graybar
2	2	Rubber Gloves, Size 10, Salisbury #100-10, Graybar
10	10	Swamp Anchors, Chance #816
150	250	Split Bolt Connectors, Reliable #210F, Graybar
75	125	Split Bolt Connectors, Reliable #6F, Graybar

TABLE 1-9. MISCELLANEOUS MAINTENANCE MATERIAL (CONT)

QUANTITY		DESCRIPTION
RECEIVER SITE	TRANSMITTER SITE	
20	30	Guy Thimbles, 1/4", Hubbard #7643, Graybar
40	60	Guy Thimbles, 3/8", Hubbard 7593, Graybar
20	30	Turnbuckles, 12" X 1/2", Locke #7604, G. E. Supply
1000 ft.	1000 ft.	Mylar Guy Line, 3/8"
4	4	Goggles
50 sheets	50 sheets	Assorted Sandpaper
7 gallon		Sonic Cleaner Concentrate, Bendix #251
4 lbs.		Potassium Hydroxide
12 lbs.		Sodium Metasilicate
1		Scale, Calibrated in grams, 2 to 5 lbs.
5 lbs.		Teletype grease, Teletype Corp. #88973
1 gallon		Teletype Oil, Teletype Corp. #88971
4	2	Squirt Type Oil Cans
1500		TTY Paper, Single Ply
750		TTY Paper, Two Ply
4000		TTY Paper Reperf Tape
1		#015-030 Probe, Type P-6016 & Type 131 Amplifier

SECTION II

AN/TSC-35 SIGNAL DISTRIBUTION

2-1. INTRODUCTION.

This section describes the signal distribution components and the signal distribution system as installed at the AN/TSC-35 Communication Station. A detailed description and the technical characteristics for each signal distribution component are contained in separate instruction manuals which are furnished with the system.

2-2. GENERAL.

The AN/TSC-35 signal distribution network is comprised of distribution frames, tone converter modulators and demodulators, telegraph terminal equipment, voice terminal equipment, microwave equipment, shielded signal cable, signal duct and signal junction boxes. Signal circuits from individual equipments at each site are interconnected into operating circuits at signal distribution frames, and the two sites are interconnected by means of a microwave system. The microwave equipment and signal duct are described in Section I of this volume.

2-3. SIGNAL DISTRIBUTION FRAMES.

Signal distribution frames installed at the Receiving Central include a RED Main Distribution Frame (MDF) in container RB1, a BLACK MDF in container RE1, a receivers Intermediate Distribution Frame (IDF) in container RE3, a Special Distribution Frame (SDF) in container RE2, and separate RED and BLACK SDF's in container RA3. At the transmitting site, an audio MDF and a DC MDF are installed in container TC1.

2-4. Each distribution frame consists of a program board and an associated monitoring patchfield. All signal circuits are completed on the program boards by means of special program patchcords. The associated patchfields are normally used for monitoring, trouble isolation, or to temporarily by-pass a defective equipment or component. The MDF and IDF program boards are housed in special racks that are 26 inches wide and the same height and depth as standard AN/TSC-35 racks. Associated patchfields are housed in separate standard AN/TSC-35 equipment racks. Each SDF program board and associated patchfield is housed in a standard rack with the patchfield mounted above the program board.

2-5. TYPICAL PROGRAM BOARD CONSTRUCTION.

Typical construction details of an AN/TSC-35 program board are illustrated in figure 2-1 which shows the partially completed BLACK MDF in container RE1. Twin coaxicon connector blocks are mounted on a steel framework that is recessed in an equipment rack. The framework is hinged so it can be swung forward for

access to the rear of the coaxicon blocks during cable installation or trouble shooting. The incoming cables are brought into the rear of the rack and are ty-wrapped to horizontal tie-bars along the rear, then looped back along the rear of the blocks and clamped at the block locations.

2-6. COAXICON CONNECTOR BLOCK AND CONNECTORS. Each coaxicon connector block (see figure 2-2) mounts 12 female coaxicon connectors. The connectors are mounted in two rows with six connectors in each row. The coaxicon connectors are solderless tip-ring-sleeve receptacles that mount in the blocks in only one position to ensure positive mating between male and female connector blocks. A shielded single-pair cable is crimped to each coaxicon connector by means of a special crimping tool that connects the tip, ring and shield of the cable to a coaxicon connector tip, ring and shell in one crimping operation. The connector is inserted into the block after the cable is connected and is retained in the block by a spring. The method used to terminate cables on coaxicon connectors and blocks is detailed in figure 2-3.

2-7. Each MDF and IDF program board has mounting facilities for 120 coaxicon connector blocks. The blocks are installed in 30 horizontal rows of four blocks in each row, providing a total of 60 rows of connectors with 24 connectors in each row.

2-8. The SDF program board installed in container RE2 mounts 10 rows of coaxicon blocks with three blocks in each row providing twenty rows of connectors with 18 connectors to a row. Each SDF program board that is installed in container RA3 mounts 9 rows of coaxicon blocks with 3 blocks to a row, providing 18 rows of connectors with 18 connectors in each row.

2-9. PROGRAM PATCHCORDS. Each program patchcord is constructed of a length of single-pair shielded cable equipped with a male coaxicon connector at each end. Lengths of the patchcords range from 12 inches to 96 inches. Patchcords are furnished in sufficient quantities to program all circuits appearing on the program boards. Patchcords furnished for the RED distribution frames are equipped with red male coaxicon connectors and all others have white male connectors.

2-10. SIGNAL GROUNDING. Grounding of all signal circuits is accomplished at the RED and the BLACK Main Distribution Frames only. A separate insulated signal ground bus is provided for the RED and for the BLACK signal circuits at the Receiving Central. On each program board, the drain wires of all signal pairs are tied to a signal ground bus mounted on, but insulated from, the framework. The bus is connected to an insulated signal-ground bus wire at the bottom of the program board by means of a flexible jumper. The ground

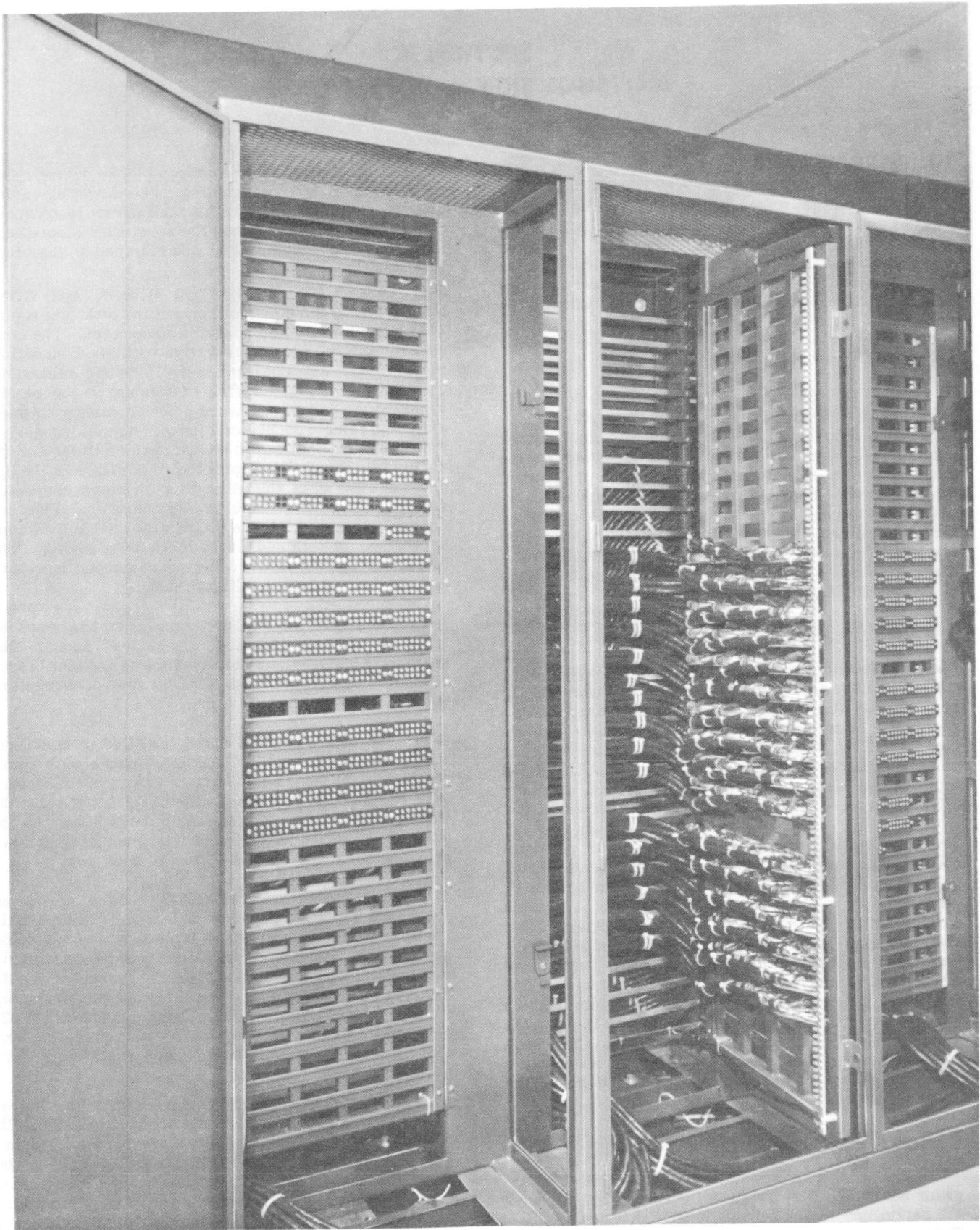

Figure 2-1. BLACK MDF Installation, Container RE1

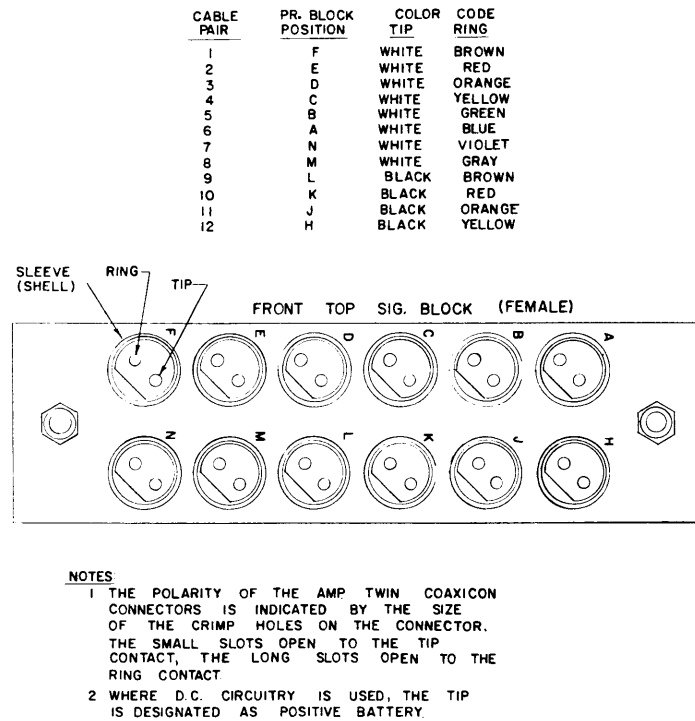

Figure 2-2. Twin-Coaxicon Signal Block, Female, Typical

bus from each MDF is a number 4/0 insulated black wire and is a continuous run to the station earth ground located near the generator complex. At this point, the signal ground, the equipment ground, and the AC power neutral bus are tied to the earth ground grid.

2-11. The signal ground of each circuit is an insulated, continuous ground connection from a main distribution frame to the equipment at which the signal originates or terminates. A signal ground connection from an MDF is carried through a signal junction box connection through the shells of the mating coaxicon connectors. At an intermediate equipment in the signal circuit, such as a tone converter unit, the signal ground is carried around the unit by tying together the drain wires of the incoming and outgoing signal pairs. When the signal pair reaches the originating or terminating equipment of the circuit, the shield is not connected to the equipment but is ended and completely insulated at this point to prevent ground loops in the signal distribution system. The drain wires of signal trunk lines, which are installed between main distribution frames and associated intermediate or special distribution frames, are connected to the signal ground bus at the main distribution frame only in order to avoid creating ground loops in this portion of the signal distribution system.

2-12. PROGRAM BOARD AND CONNECTOR DESIGNATIONS. Each program board is identified by its rack locator number according to the rack numbering system explained in paragraph 1-85 in this volume. Each horizontal row of connectors across an MDF or IDF program board is numbered from 1 through 24

from left to right. The 60 rows of connectors are designated by double letter symbols AA, AB, AC, etc. through CH from top to bottom. Thus, in order to locate any connector on a program board, all that is required is the double letter designation to locate the row and a number to locate the connector in the row, such as AZ-16 which identifies the 16th connector of the AZ row on the program board.

2-13. The same connector numbering system is used on the SDF program boards. The 20 rows of coaxicon connectors on the SDF program board in container RE2 are lettered AA through AT, and the connectors are numbered 1 through 18 from left to right. In container RA3, the 18 rows of connectors on both SDF program boards are lettered AA through AS, and numbered from 1 through 18. Locator numbers and connector designations are used on cable records to indicate the terminating point of cables.

2-14. TYPICAL MONITOR PATCHFIELD CONSTRUCTION.

All patchfields associated with distribution frames are equipped with tip-ring-sleeve jacks. The audio patchfields consist of normal-through MONITOR-LINE-EQUIPMENT jack circuits and MISCELLANEOUS jack circuits. All LINE, EQUIPMENT and MISCELLANEOUS jacks are wired to female coaxicon connectors on an associated program board. The MONITOR jacks are connected in parallel with their associated LINE jacks. The DC patchfields consist of LOOP-LOOP-SET 1-SET 2 jack circuits and MISCELLANEOUS jack circuits. A LOOP and both SET jacks of each circuit, as well as the MISCELLANEOUS jacks,

are wired to female coaxicon connectors on an associated DC program board. The second LOOP jack is connected in series with its associated loop. All jackstrips, except the MISCELLANEOUS strips, are mounted on hinged panels providing access to the rear of the jacks for trouble shooting.

2-15. Shielded pair wiring is used between the jacks and the coaxicon connectors. Tip-ring-sleeve wiring is used in all cases. The shield of the shielded pair is connected to both the sleeve of the jack and the shell of the coaxicon connector. The shield of each signal pair is insulated with a coating of mylar to prevent adjacent shields from making contact with equipment or other shields and causing ground loops. All patchcords provided with the patchfields have tip-ring-sleeve plugs but the shield is disconnected from the sleeve at one end of the patchcord so that a ground loop is not created when a patch is made.

2-16. A 120F meter unit, equipped for tone conversion, is provided with each audio patchfield at the Receiving Central. Three DC meters with 75-0-75 ma movements are provided for the DC MDF patchfield in container TC1. Meter input circuits are wired to jacks that are installed in the lowest jackstrip on a monitor patchfield.

2-17. RED MAIN DISTRIBUTION FRAME.

The RED MDF is the 2016 System AF Patching and Monitoring Facility consisting of two 26-inch racks housing program boards and two patchbays housed in standard AN/TSC-35 racks. Figure 2-4 illustrates the RED MDF installation in container RB1. All RED tone-converted 10-kc signals at the Receiving Central terminate and are programmed at this MDF. The applicable publication for this system is entitled the 2016 System Description, Issue 1.

2-18. RED MDF PROGRAM BOARD. Each program board mounts 120 coaxicon blocks providing a total of 2880 RED signal terminations on the two boards. The left program board is hinged on the right side while the right board is hinged on the left side. This arrangement ensures that any program patchcords that extend from one board to the other need not be disturbed when the program boards are swung open for cable installation or trouble shooting. Each program board rack is equipped with a steel door (temporarily removed for the illustration) which is hinged on the side opposite the program board hinge, providing an unobstructed view of both boards when the doors are open.

2-19. Cables from operating equipments in RB1 are brought into the rear of the program board through the rack base duct. Inter-container cables from other containers are brought into the container in overhead duct and drop down into the rear of the rack.

2-20. RED MDF MONITOR PATCHBAY. The upper half of each RED monitor patchbay houses a 120F meter unit and an audio patchfield; a drawer shelf below the patchfield; and a model 190B fuse alarm panel, a model 173 (24-volt) DC power supply, and a model 122C power distribution panel for AC at the bottom. Blank panels are installed in all unused rack spaces.

2-21. The patchfield consists of six hinged groups of 24 MONITOR-LINE-EQUIPMENT jacks, one group of 48 MISCELLANEOUS and two METER jacks. Each hinged jack group is provided with 24 green (REMOTE) and 24 red (ALARM) indicating lamps that are installed above the jacks. The indicating lamps are wired to the RED program board in the same manner as the jacks. Typical jack and lamp wiring for this patchfield is illustrated in figure 2-5.

2-22. Power to light the indicating lamps and operate the fuse alarm is provided by the 24-volt DC power supply. The AC power distribution panel furnishes AC power to the rack equipments and to a duplex utility outlet on the front of the panel. Equipment and utility power are furnished from separate junction boxes in the rack base and are separately fused on the front of the AC power distribution panel. The panel also mounts an equipment power ON/OFF switch.

2-23. BLACK MAIN DISTRIBUTION FRAME.

The BLACK MDF installed in the unclassified facility control container RE1 is the 2031 System AF Patching and Monitoring Facility and is comprised of a TTY section and an audio (AF) section. All Receiving Central BLACK tone-converted signal circuits are terminated on the TTY section while voice circuits from operating positions and receivers, telegraph terminal aggregate tones, and the microwave terminal 3-kc VF channels are terminated on the audio section.

2-24. The initial installation of the 2031 system BLACK MDF is illustrated in figure 1-19 and described in the manual entitled Model 2031 Systems Description, Issue 1. It consists of (from left to right) an audio program board, two TTY program boards, two TTY monitor patchbays, a TTY test equipment rack, and an audio monitor patchbay. Subsequent expansion of the BLACK MDF added a TTY program board and a TTY monitor patchbay at the left of the audio program board. The added components are described in the manual entitled Model 2117 Systems Description, Issue 1. The added TTY facilities are for use with the Communication System CCL circuits while the original TTY section is used for point-to-point circuits.

2-25. BLACK MDF PROGRAM BOARD. The BLACK MDF program board provides 2880 point-to-point, 1440 CCL, and 1440 VF circuit terminations. The description of a typical program board contained in paragraph 2-5 applies to each board in this system. All inter-container cables are brought into the container in overhead signal duct and drop down into the rear of the program board racks, while cables from the RE1 equipments enter the racks through rack base duct.

2-26. The hinges on the point-to-point program boards and the rack doors are arranged in the same manner as those on the RED program board. In order to avoid extremely long program patchcords, 48 signal trunks are installed between the CCL and the point-to-point TTY program boards.

2-27. BLACK MDF MONITOR PATCHBAY. Each monitor patchbay in this group contains a model 120F meter unit, an audio patchfield, and a drawer-shelf

STEP 5

REMOVE PAIRS FROM BLOCK AND PREPARE AS SHOWN

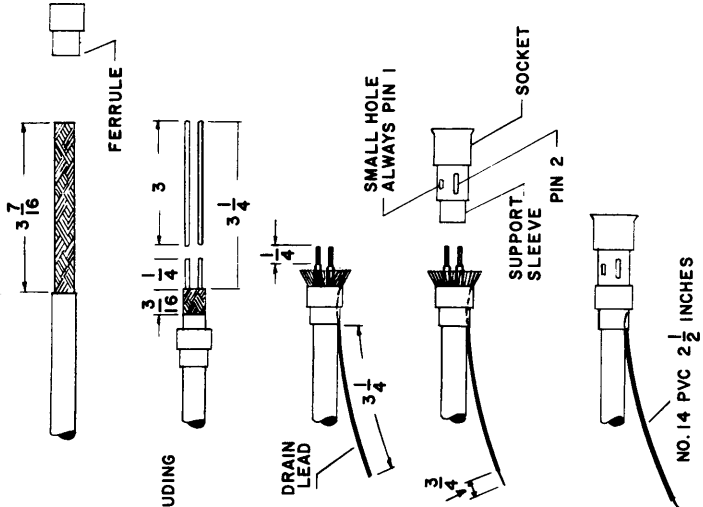

1. STRIP OUTER JACKET FROM CABLE EXPOSING 3 7/16 INCHES OF BRAIDED SHIELD.
2. STRIP BRAID BACK 3/4 INCH AND CUT OFF.
3. CUT THE 2 CONNECTORS BACK 3 INCHES LEAVING DRAIN LEAD FULL LENGTH AND CONDUCTORS PROTRUDING 1/4 INCH BEYOND BRAIDED SHIELD.
4. STRIP BOTH CONDUCTORS 1/4 INCH AND FLARE BRAID.
5. SLIDE FERRULE BACK, AND FEED END OF DRAIN LEAD UNDER IT, THEN SLIDE FERRULE TO END OF OUTER JACKET AND PULL DRAIN LEAD OUT TAUT.
6. INSERT CONDUCTORS INTO SOCKET AS FAR AS THEY WILL GO, PER COLOR CODE. BRAID GOES OVER AND AROUND SUPPORT SLEEVE ON SOCKET. ORIENT AS SHOWN.
7. SLIDE FERRULE FORWARD AND OVER BRAID UNTIL FERRULE IS EVEN WITH SHOULDER ON SOCKET. CRIMP IN PLACE, USING SPECIAL TOOL.
8. SLIDE A 2 1/2 INCH LENGTH OF SLEEVING OVER DRAIN LEAD AND UNDER END OF FERRULE.

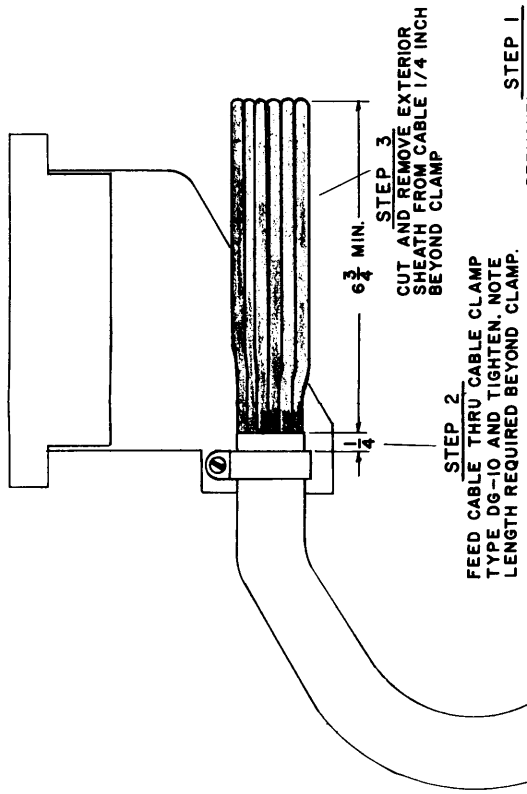

COLOR CODING		PIN 1	PIN 2	PIN 1	PIN 2
(A)	WHITE	BLUE	BLACK	(H)	YELLOW
(B)	WHITE	GREEN	BLACK	(J)	ORANGE
(C)	WHITE	YELLOW	BLACK	(K)	RED
(D)	WHITE	ORANGE	BLACK	(L)	BROWN
(E)	WHITE	RED	WHITE	(M)	GRAY
(F)	WHITE	BROWN	WHITE	(N)	VIOLET

STEP 4
DRESS LEADS THRU HOLES IN CONNECTOR BLOCK PER COLOR CODING. DRESS LEADS TO ELIMINATE EXCESSIVE CROSSOVER. GENTLY TENSION LEADS TO REMOVE SLACK. THEN CUT ALL WIRES TO LENGTH OF 2 5/8 INCHES FROM FACE OF BLOCK AS SHOWN.

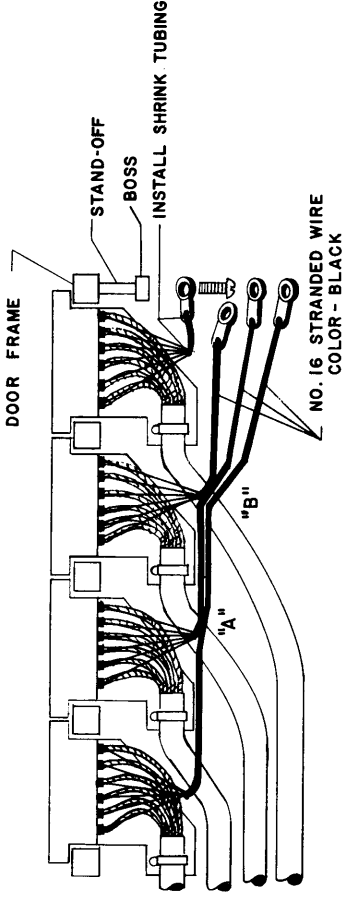

STEP 6

1. BRING OUT THE 12 DRAIN LEADS FROM EACH CONNECTOR BLOCK AND SOLDER TOGETHER, TRIMMING AND TINNING AS NEEDED. COVER SOLDER JOINT WITH ELECTRICAL TAPE AND NO. 2 SHRINK TUBING.
2. SOLDER EACH GROUP OF 12 DRAIN LEADS TO ONE END OF A NO. 16 WIRE CUT TO LENGTH OF 16 INCHES OR LESS, AS REQUIRED TO MEET BUSS. SOLDER OTHER END OF WIRE TO SOLDER LUG ON BUSS, PARALLEL WITH CONNECTOR BLOCK. NOTE - A SEPARATE LUG AND MOUNTING HOLE IS PROVIDED FOR EACH GROUND WIRE. USE SHRINK TUBING ON BOTH ENDS OF GROUND WIRE AND DRESS WIRE NEATLY.
3. USE "TY-RAPS" TO SECURE GROUND WIRES TO SIGNAL CABLE AT POINTS "A" AND "B".

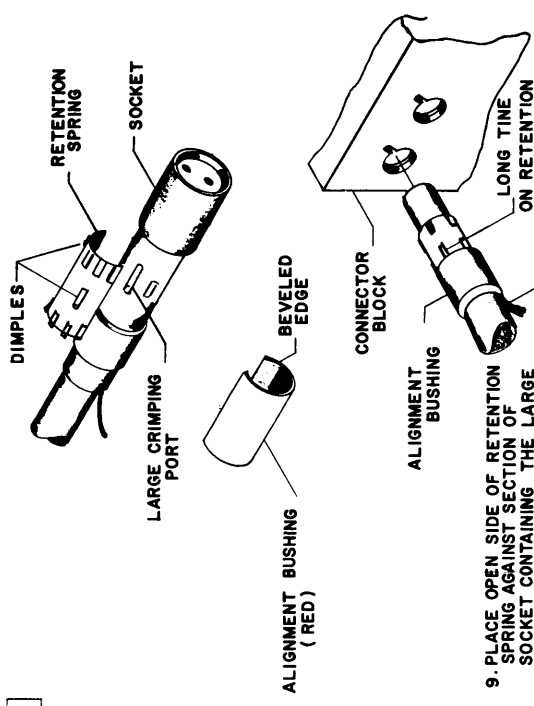

9. PLACE OPEN SIDE OF RETENTION SPRING AGAINST SECTION OF SOCKET CONTAINING THE LARGE CRIMPING PORTS. PRESS INTO PLACE, DRAIN ROTATING SLIGHTLY AS NECESSARY UNTIL DIMPLES LOCK INTO CRIMPING PORTS. BE SURE TABS ON SPRING ARE ORIENTED AS SHOWN, WITH SLANTING TABS IN FRONT AND PERPENDICULAR TABS TO THE REAR.
10. SNAP ALIGNMENT BUSHING INTO PLACE OVER REAR END OF FERRULE, WITH BEVELED EDGE TO THE REAR.
11. INSERT SOCKET INTO PROPER HOLE IN CONNECTOR BLOCK, MAKING SURE LONG TINE ON RETENTION SPRING IS LINED UP WITH POLARIZING GROOVE IN CAVITY. PUSH SOCKET IN AS FAR AS IT WILL GO. PULL BACK GENTLY TO MAKE SURE SOCKET IS SECURED IN CAVITY. OBSERVE COLOR CODING WHEN PUTTING WIRES BACK INTO CONNECTING BLOCK.

Figure 2-3. Wiring Standard MDF Block Cable Termination

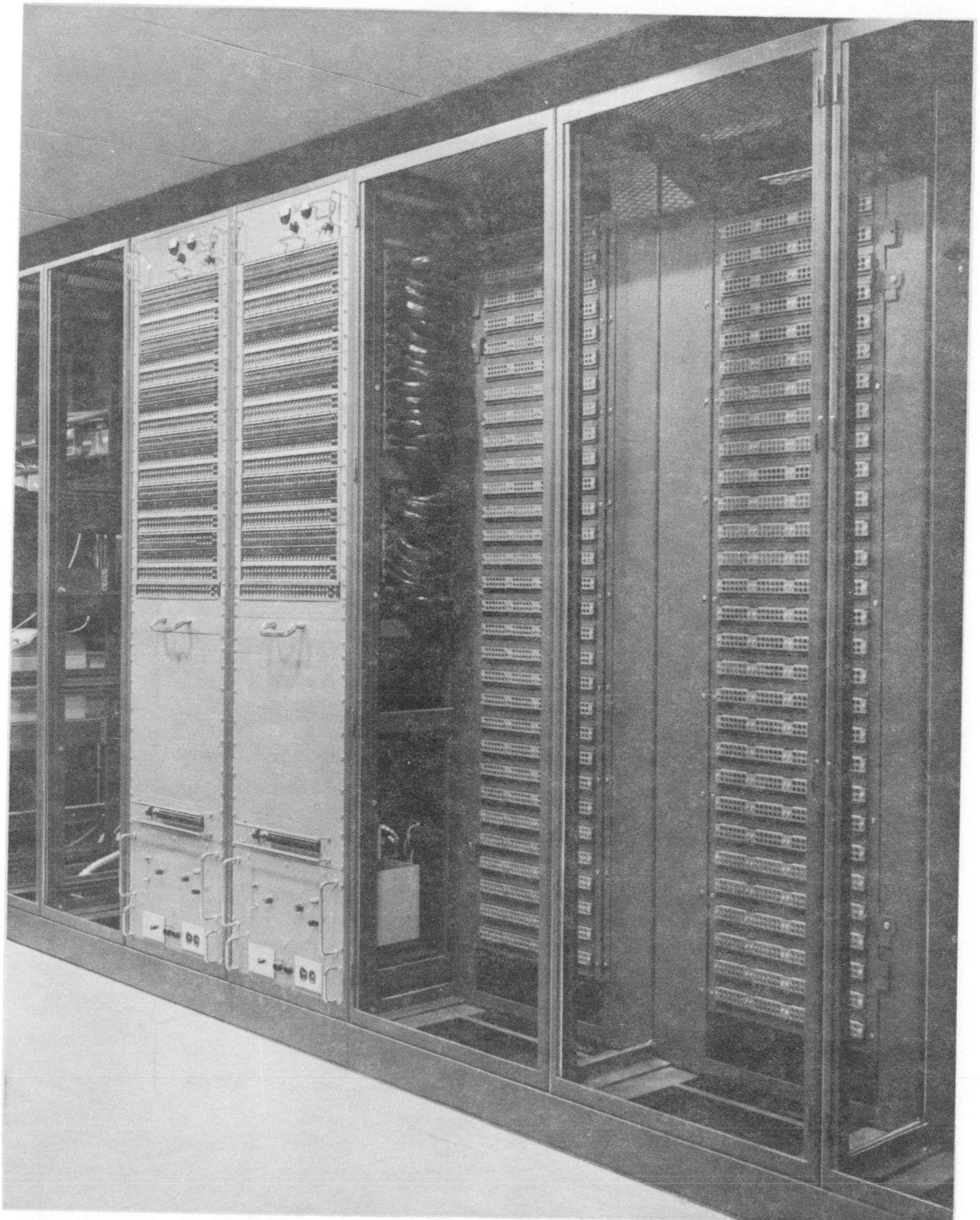

Figure 2-4. RED MDF Installation, Container RB1

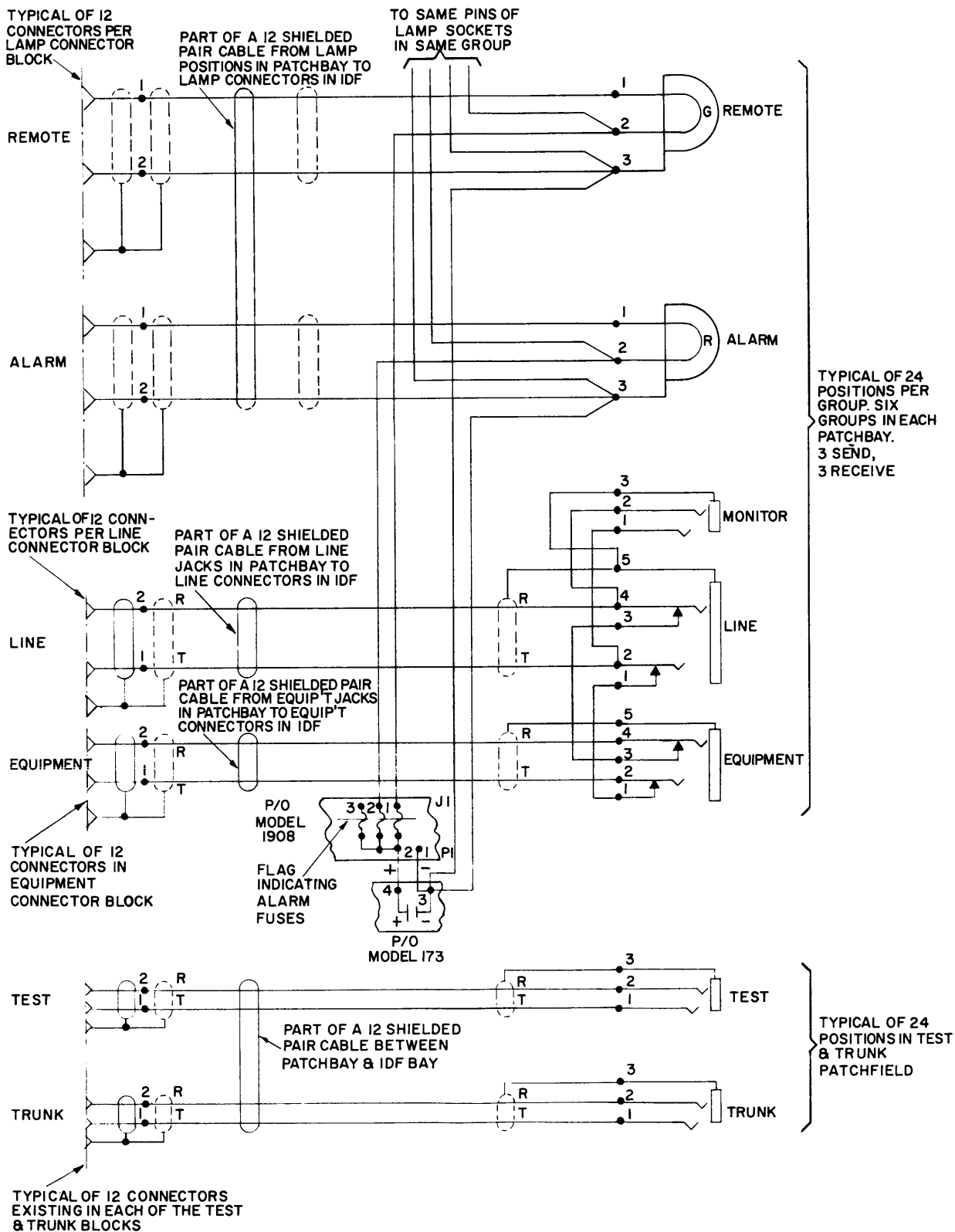

Figure 2-5. RED Audio Patchfield, One Position, Typical Jack Wiring

in the upper portion, and a model 122C AC power distribution panel at the bottom. Blank panels fill the intervening spaces.

2-28. The patchfield consists of four hinged groups of jacks each mounting 24 SEND and 24 RECEIVE MONITOR-LINE-EQUIPMENT jack circuits; and one fixed jackstrip containing 48 MISCELLANEOUS jacks and 2 METER jacks. The METER jacks are located on the right end of the MISCELLANEOUS jackstrip and are connected to the VU and M/S IND inputs of the 120F meter unit. Typical jack wiring of a SEND, a RECEIVE and a MISCELLANEOUS jack circuit is illustrated in figure 2-6.

2-29. RECEIVERS INTERMEDIATE DISTRIBUTION FRAME.

The receivers IDF installed in container RE3 is a 2013 System AF Patching and Monitoring Facility consisting of one 26-inch rack housing a program board and one standard patchbay rack. The program board provides 1440 circuit terminations and construction is identical to the program board described in paragraph 2-5. The associated patchbay is identical to the BLACK MDF monitor patchbay described in paragraph 2-27, and typical jack wiring is illustrated in figure 2-6. The applicable instruction manual for this system is entitled the 2013 Systems Description, Issue 1.

2-30. The audio signal circuits of all equipments in container RE3 are terminated on this IDF program board. Circuits include receiver outputs, frequency-shift converter audio inputs and tone converted outputs, TD-411 demultiplexer inputs and outputs and tone converted order-wire TTY signals. The signal circuits on this board are programmed to trunk lines that terminate on the BLACK MDF in container RE1. Ninety-six trunks are provided between this program board and the BLACK MDF, forty-eight appearing on the TTY section of the BLACK MDF and forty-eight on the AF section.

2-31. TRANSMITTERS AUDIO MAIN DISTRIBUTION FRAME.

The audio MDF installed in the transmitter control container TC1 at the Transmitting Central is a modified 2013 System AF Patching and Monitoring Facility comprised of one 26-inch program-board rack and one audio patchbay mounted in a standard rack. The 120F meter unit is not modified for tone conversion.

2-32. AUDIO MDF MODIFICATION. The 2013 system was modified after initial installation by the addition of one hinged group of 24-SEND and 24-RECEIVE MONITOR-LINE-EQUIPMENT jack circuits. To accommodate the additional jack group, the miscellaneous jack-strip and the drawer shelf were lowered sufficiently to permit mounting the additional hinged jack group. In all other respects, this system is identical to the receivers IDF which is described in the 2013 Systems Description, Issue 1, manual.

2-33. AUDIO SIGNAL CIRCUITS. All audio signal circuits at the Transmitting Central terminate at the audio MDF program board in the transmitter control

container. Audio circuits appearing on this program board include microwave terminal 3-kc VF channels, transmitter audio input circuits, TH-39A/UGT Tone Intelligence Unit audio input circuits, CCL telegraph terminal aggregate tones, and TD-410 multiplexer input and output circuits.

2-34. TRANSMITTERS DC MAIN DISTRIBUTION FRAME.

The DC MDF installed in the transmitters control container TC1 is a 2015 System DC patching and monitoring facility comprised of one 26-inch program-board rack and one DC patchbay. All DC circuits appearing on this program board originate in the control container. The DC signal circuits are programmed to TIS units for conversion to an audio form and then programmed to transmitting equipments from the audio MDF. The transmitter control circuits are not tone-converted but are programmed to transmitters at the DC MDF.

2-35. TRANSMITTERS DC PROGRAM BOARD. The DC program board provides 1440 DC circuit terminations and is identical in construction to the program board described in paragraph 2-5. Signal and control circuits terminated at this program board include the DC output channels of the CCL telegraph terminals, TTY internal order-wire circuits, DC inputs to the TIS units, and spare 60-ma battery circuits.

2-36. TRANSMITTERS DC MONITOR PATCHBAY. The DC monitor patchbay houses a 96-circuit telegraph patchfield, a MISCELLANEOUS jackstrip, and three 75-0-75 ma DC meters mounted above the patchfield. The telegraph patchfield consists of four hinged groups of jacks each containing 24 DC jack circuits. Each circuit consists of two LOOP jacks, two SET jacks, and one MISCELLANEOUS jack. Typical jack circuit wiring is illustrated in figure 2-7. The MISCELLANEOUS jackstrip is equipped with twenty-four jacks designated TEST and 24 designated TRUNK, and three DC METER jacks. The METER jacks are wired to the three milliameters at the top of the rack.

2-37. Normally, the DC patchfield is used for monitoring the DC circuits and setting loop currents. This is done by patching a meter into a LOOP jack. The SET jacks are provided with a resistor that replaces the SET jack equipment in the loop circuit when a dummy patch is made into a SET jack. This insures that the loop current will remain essentially constant when such a patch is made to by-pass a defective equipment or during trouble shooting.

2-38. SPECIAL DISTRIBUTION FRAMES.

Special distribution frames are provided for programming equipments in the immediate area of the SDF into complete circuits which are then programmed to main distribution frames. Signal trunks from the SDF locations to the appropriate MDF are installed for this purpose.

2-39. SPECIAL DISTRIBUTION FRAME, RE2. The SDF installed in container RE2 is a 2014 System AF

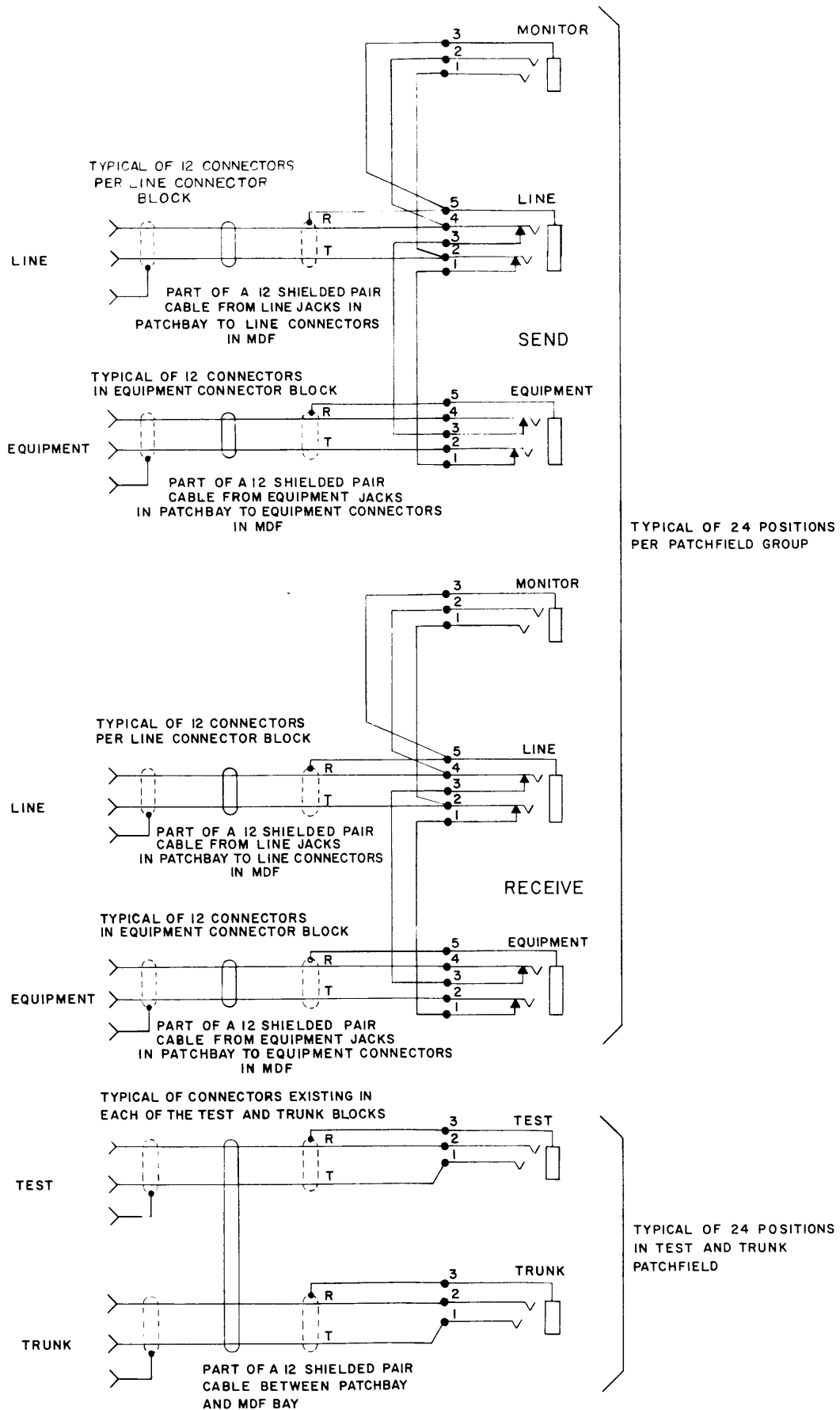

Figure 2-6. BLACK Audio Patchfield, One Position, Typical Jack Wiring

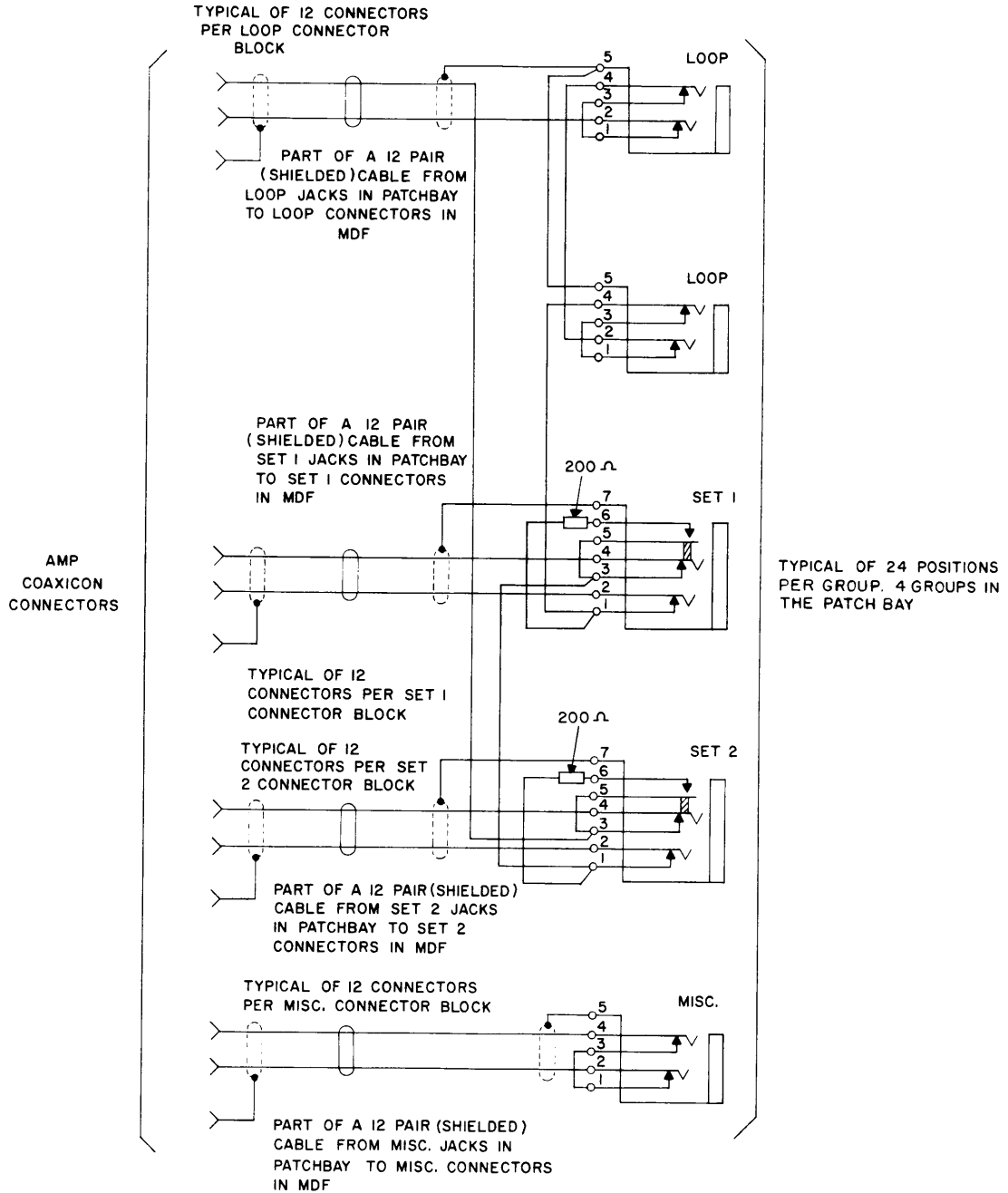

Figure 2-7. DC Patchfield, One Position, Typical Jack Wiring

Patching and Monitoring Facility installed in one equipment rack together with other equipment that is not part of the SDF. The program board is installed in the bottom portion of the rack and the associated monitor patchfield in approximately the middle. Program board and patchfield construction is the same, except for physical size, as described for the black MDF program board and patchfields. The manual supplied with this system is entitled the Model 2014 Systems Description (Issue 1).

2-40. RE2 SDF Program Board. The program board provides 360 audio circuit terminations on 30 coaxicon

connector blocks. The equipment installed at and adjacent to the voice operating position in this container are terminated at the SDF program board. Thirty-six trunks to the BLACK MDF in container RE1 are provided.

2-41. RE2 SDF Monitor Patchfield. The SDF Monitor patchfield consists of one hinged group of audio jacks containing 24-SEND and 24-RECEIVE MONITOR-LINE-EQUIPMENT jack circuits and 48 MISCELLANEOUS jacks. Figure 2-6 illustrates typical wiring of the jack circuits.

2-42. RED SPECIAL DISTRIBUTION FRAME, RA3. The RED SDF installed in container RA3 is a 2116A System AF and DC Patching and Monitoring Facility installed in one standard equipment rack. (See figure 2-8). A model 120F meter unit modified for tone conversion of the MARK/SPACE INDICATOR input is mounted in the top of the rack and wired to two jacks in the center of the bottom jackstrip of the patchfield. The program board is installed at approximately the middle of the rack with the patchfield directly above. An AC power distribution panel is installed at the bottom of the rack. The manual supplied with this system is entitled Model 2116 Systems Description, (Issue 1).

2-43. RA3 SDF RED Program Board. The RED SDF program board provides 216 DC and 108 audio circuit terminations. The DC section is at the top of the board with a space between it and the audio section at the bottom. Red coaxicon blocks, connectors, and the program patchcords are used on this program board. Twelve trunks to the RED MDF in container RB1 are provided.

2-44. RA3 SDF RED Monitor Patchfield. The RED monitor patchfield consists of one hinged group of jacks containing 24 DC jack circuits, 24 audio jack circuits and two METER jacks. Each DC jack circuit consists of two LOOP, two SET and one MISCELLANEOUS jack. Figure 2-7 illustrates typical jack wiring for a DC jack circuit. Each audio jack circuit consists of a MONITOR, LINE, and EQUIPMENT jack wired in the same manner as illustrated for a SEND or a RECEIVE circuit in figure 2-6. The left half of the patchfield is designated SEND and the right half RECEIVE. Red tipping-sleeve patchcords are furnished for the patchfield.

2-45. BLACK SPECIAL DISTRIBUTION FRAME, RA3. The BLACK SDF installed in container RA3 is a 2116B System AF and DC Patching and Monitoring facility that is identical to the RA3 RED SDF with the exception that white coaxicon connectors, black coaxicon blocks and black patchcords are used instead of red. Twelve trunks to the BLACK MDF in container RE1 are provided. The applicable instruction manual is the 2116 Systems Description (Issue 1).

2-46. TONE CONVERTER MODULATORS AND DEMODULATORS.

The signal tone converter system for TTY, transmitter control, and CW keying signals at the Receiving Central utilizes 6002-1 modulators and 6002-2 demodulators. The 6002-1 modulator converts the mark-space or contact closure signal to a 10-kc phase-shifted signal, and the 6002-2 demodulator converts the signal back to its original form. A detailed discussion of the tone conversion system as employed at the Receiving Central is contained in Section 3 of Volume 2 of this manual.

2-47. TRIP CONTROL MODULATORS AND DEMODULATORS.

For the TD trip control circuits, 6004-1 modulators and 6004-2 demodulators are used. The 6004-1 mod-

ulator converts a TD trip signal provided by a cryptographic equipment to 2167.5 cycles for a mark condition and to 2082.5 cycles for a space condition. At the opposite (TD) end of the trip control circuit, the 6004-2 demodulator reconverts the trip control signal back to its original form. The tone-converted TD trip-control signal is fed back to the associated TD equipment over the same signal pair that carries the TD TTY tone-converted output.

2-48. TELEGRAPH TERMINAL EQUIPMENT.

Model AN/FGC-60(V) tone telegraph terminal equipments are installed in the unclassified control center RE1 and in the transmitter control center TC1. All telegraph terminals at the Receiving Central are equipped for tone conversion at the telegraph channel inputs and outputs. Fourteen telegraph terminal equipments are installed at the Receiving Central and two at the Transmitting Central.

2-49. RECEIVING CENTRAL TELEGRAPH TERMINALS.

Telegraph terminals installed at the Receiving Central include eight AN/FGC-60/24 systems, four AN/FGC-60/22 systems, one AN/FGC-60/19 system, and one AN/FGC-60/23A system.

2-50. AN/FGC-60/24 SYSTEM. The 60/24 system is a 16-channel, full-duplex, voice frequency telegraph terminal that is used on point-to-point circuits. This system has provisions for dual and quadruple diversity operation. Each system is installed in two standard AN/TSC-35 equipment racks and is equipped with sixteen 6002-1 modulators and sixteen 6002-2 demodulators for the signal circuits and one 6002-2 demodulator for the meter circuit. The manual supplied with this system is entitled the 60/24 Systems Description.

2-51. AN/FGC-60/22 SYSTEM. The 60/22 system is a 16-channel, full-duplex, non-diversity, voice frequency telegraph terminal that is used on both point-to-point and CCL circuits. The 60/22 system is housed in one standard equipment rack and is equipped with sixteen each 6002-1 and 6002-2 tone converters for the signal circuits and one 6002-2 for the meter circuit. The applicable manual is the 60/22 Systems Description.

2-52. AN/FGC-60/19 SYSTEM. The 60/19 system is a 12-channel, full-duplex, non-diversity, VF telegraph terminal that is used on CCL circuits. It provides four wide band channels for high speed keying and eight standard narrow band channels. The system is housed in one standard equipment rack and is equipped with twelve each 6002-1 and 6002-2 tone converters for the signal circuits and one 6002-2 demodulator for the meter circuit. The 60/19 Systems Description manual is furnished with this system.

2-53. AN/FGC-60/23A SYSTEM. The 60/23A system is a send 24-channel, non-diversity, VF telegraph terminal that is used on CCL circuits. It provides two sets of twelve send channels, each set comprised of four wide-band channels and eight narrow-band channels. The system is housed in one standard rack and

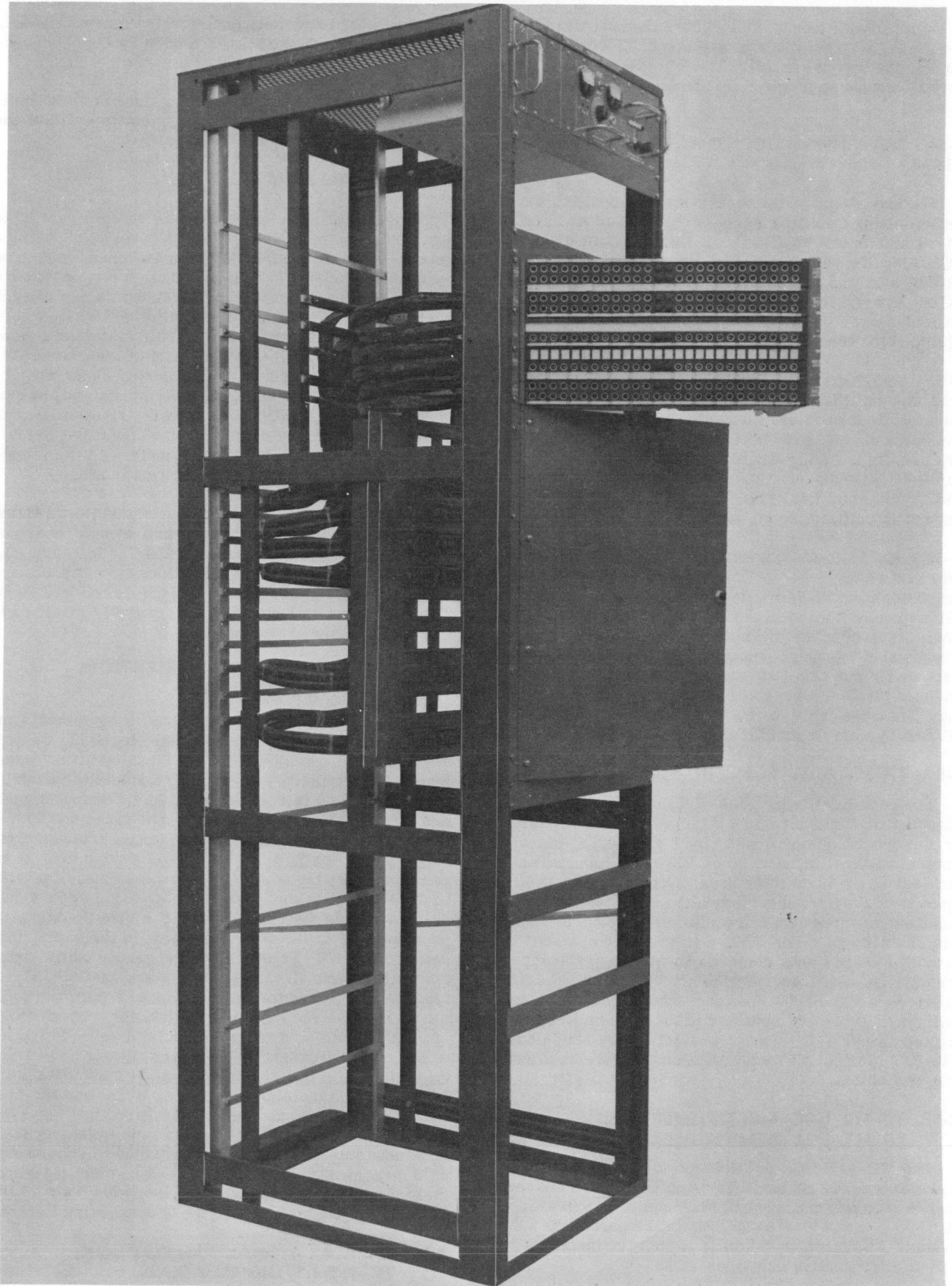

Figure 2-8. RED SDF, Construction Details

is equipped with twenty-four 6002-2 demodulator units for the signal input circuits and one 6002-2 demodulator for the meter circuit. The 60/23A Systems Description manual, Issue 1, is furnished with this system.

2-54. TRANSMITTING CENTRAL TELEGRAPH TERMINALS.

The two telegraph terminal systems installed at the Transmitting Central control center are an AN/FGC-60/29 and an AN/FGC-60/23B that are both used on CCL circuits with the Receiving Central 60/19 and 60/23A systems respectively. The telegraph channel DC outputs and inputs are wired to the DC MDF in this control center. These telegraph terminals are not equipped for tone conversion.

2-55. AN/FGC-60/29 SYSTEM. The 60/29 system is a 12-channel, full-duplex, non-diversity VF telegraph terminal that provides four wide-band and eight narrow-band channels for both send and receive circuits. The system is equipped with a loop power supply, loop-current control panel, a fuse and alarm panel and audio and DC metering facilities. The applicable instruction manual is entitled the 60/29 System Description.

2-56. AN/FGC-60/23B SYSTEM. The 60/23B system is a receive 24-channel, non-diversity VF telegraph terminal that provides two twelve channel receive groups housed in one standard equipment rack. Each group consists of four wide-band and eight narrow-band telegraph channels. The system furnishes its own 60-ma loop battery supply with each receive channel. It is equipped with both audio and DC metering. The applicable instruction manual is entitled the 60/23B System Description, Issue 1.

2-57. TH-39A/UGT TONE INTELLIGENCE UNIT.

The Tone Intelligence Unit (TIS) provides audio tone outputs that modulate a SSB transmitter for FSK, FAX or CW modes of operation. Input DC keying signals may be voltage keyed at 50 or 100 volts, or current-keyed at 20 or 60 milliamperes. Output tones for FSK operation are variable from 12 to 1000 cps centered about one of three center frequencies at 1900 cps, 2000 cps or 2550 cps. For FAX, a linear 1000 cps shift is provided that is also centered about one of the three frequencies noted above. For CW operation, the TIS provides a fixed 1000 cps tone output. All Tone Intelligence Units are installed in the transmitter control container TC1. The Tone Intelligence Unit Model TIS-3 (TH39A/UGT) Technical Manual is furnished with this equipment.

2-58. TD-410/UGC MULTIPLEXER AND TD-411/UGC DEMULTIPLEXER.

The TD-410/UGC multiplexer combines two 3-kc voice-frequency channels into one 6-kc voice channel that is used to modulate one sideband of an SSB transmitter. Sixteen TD-410/UGC units are part of the 2029 System Multiplexing Facility which is installed in transmitter control container TC1.

2-59. The TD-411/UGC demultiplexer accepts a 6-kc sideband from a SSB receiver and provides two 3-kc

VF channels to receiving equipment. Sixteen TD-411/UGC units, which are part of a 2030 System Demultiplexing Facility, are installed in container RE3.

2-60. The instruction manual furnished for the multiplexer and demultiplexer equipment is entitled the 2029-2030 System Description.

2-61. SIGNAL JUNCTION BOX.

A signal junction box is similar in construction to a program board. It consists of a steel box housing a recessed hinged frame that mounts female coaxial connector blocks. The signal junction box provides a method of quickly connecting the signal cables of each container into the signal distribution system. Where RED and BLACK signal cables are installed in a container, separate RED and BLACK signal junction boxes are provided. The signal cables in each container terminate in the container signal junction box and are then extended to the appropriate main distribution frame. The cables leaving a container are connected to male coaxial connector blocks which mate with the female blocks installed in the signal junction boxes.

2-62. Signal junction boxes are provided in two sizes; a large box that mounts twenty-four female coaxial blocks for containers where cable loading is heavy, and a small box containing eight blocks for containers where cable requirements are comparatively light. The boxes are wall mounted and generally installed in line with the signal ducting.

2-63. TYPICAL SIGNAL DISTRIBUTION, RECEIVING CENTRAL.

All signal circuits between operating equipments and the main distribution frames at the Receiving Central are carried over shielded signal cables at low audio levels. Teletype, cryptographic, transmitter control, CW keying, and telegraph terminal DC output signals are converted to 10-kc phase-shift tones by 6002-1 modulators and TD trip-control signals are converted to frequency-shift tones by 6004-1 modulators at or near the operating equipments or positions. Each 10-kc tone signal is then carried over a shielded signal pair to a main distribution frame where the signal is programmed to the next equipment in the signal flow path. The TD Trip-control frequency-shift signal shares the same signal pair as the associated TD teletype signal. At the terminal end of a circuit, the audio signal is reconverted to its original form by a 6002-2 or a 6004-2 tone converter demodulator and then applied to the next equipment in the signal flow path. Teletype signals to be transmitted, and transmitter control and CW signals, are converted to DC and fed to an AN/FGC-60 telegraph terminal where they are converted to frequency shift tones and multiplexed into 3-kc bandwidth signals. These and voice telephone signals are applied to an AN/FCC-17 voice terminal, multiplexed into widebands, and then sent over a 74B-1 microwave transmitter to the Transmitting Central.

2-64. TYPICAL SIGNAL DISTRIBUTION, TRANSMITTING CENTRAL.

At the Transmitting Central, the receive microwave signals are demultiplexed into the original 3-kc VF

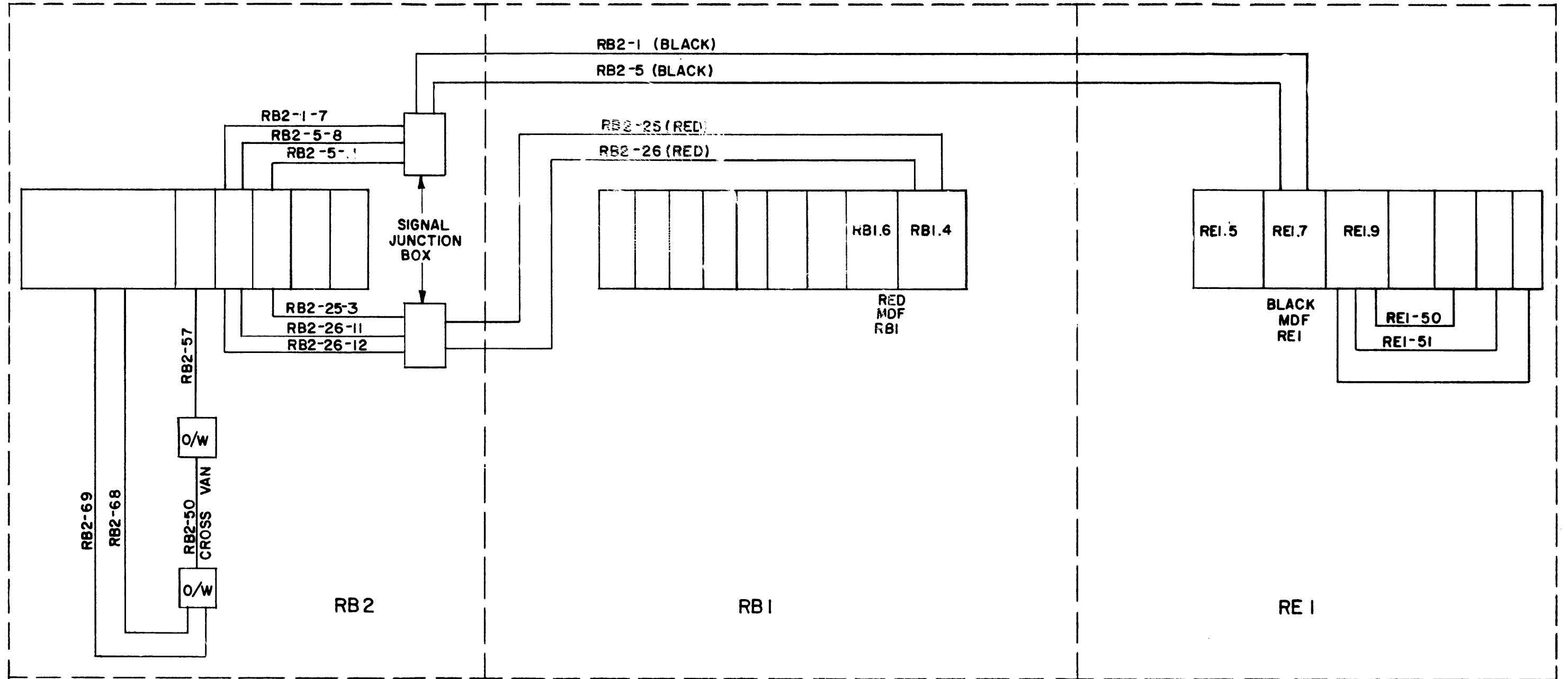

Figure 2-9. Signal Cable Numbering, Typical

bands in an AN/FCC-17 receive voice terminal whose output channels appear on the transmitters audio MDF. Point-to-point 3-kc signals (TTY tone and voice) are then programmed to TD-410 multiplexing equipment that provide 6-kc outputs which are then applied to the sidebands of a single-sideband transmitter.

2-65. Transmitter control and CW signals are programmed to receive CCL tone telegraph terminals and converted to DC. The DC outputs appear on a DC MDF where they are programmed to TH-39A/UGT Tone Intelligence Units (TIS) which convert the signals to audio tones that are then programmed to transmitters.

2-66. SIGNAL CABLES.

Signal cables used in this installation are 12-pair, 8-pair, 4-pair, and single pair cables. All signal wiring is of shielded pair construction and each pair is insulated by a mylar coating over the shield. Each signal pair consists of two number 22 signal wires, a drain wire, and a shield. The drain wire and shield are common and the drain wire is used to ground the shield at the Main Distribution Frames. The table in figure 2-2 contains the color code and tip-ring designations for a 12-pair AN/TSC-35 cable. The color code for a 4-pair and an 8-pair cable would be the same as the color code for the first four pairs and the first eight pairs, respectively, of the 12-pair cable. Single pair cables have white and brown signal wires.

2-67. SIGNAL CABLE IDENTIFICATION SYSTEM.

Signal cables are identified by letter-number combinations which indicate the general location of the cables. The cable numbering system is based on the container numbering system which was discussed in paragraph 1-21. Signal cables fall into three general categories:

- a. Inter-Container Cables
- b. Intra-Container Cables
- c. Intra-Rack Signal Pairs

2-68. INTER-CONTAINER CABLES. Inter-container cables carry signals between two containers. These cables are assigned a container number followed by a dash and then a number, such as RB2-1 for cable number 1 from container RB2 to the MDF. This holds true except for the station clock system and the voice intercom system cables which are assigned the letters CL and IC respectively. Inter-container cables are assigned the block of numbers from 1 through 49. In containers having both BLACK and RED circuit cables, the BLACK circuit cables are numbered from 1 through 24, and the RED circuit cables from 25 through 49. At the Transmitter site, the inter-container cable numbering is modified to identify the function of the cables and to furnish a more specific location of cable terminations. These cables are assigned a cable number that is similar to the transmitter rack or location number and a letter suffix which identifies the function of the cable. Suffix letters R, S, and T are used; R for the RF, coax cables; S for the signal cables; and T for the interlock and alarm circuit cables. As an exam-

ple, the inter-container cables for transmitter TH1.1 are numbered TH1-1R, TH1-1S, and TH1-1T.

2-69. INTRA-CONTAINER CABLES. Intra-container cables are those which connect between racks, equipments, IDF's, SDF's, etc., within a container only. Intra-container cables are numbered from 50 through as high a number as is required to number all intra-container inter-rack cables. When a signal pair leaves a cable, it retains the cable number and is given its pair number preceded by a dash, such as RB2-15-12 for pair 12 of cable RB2-15. Figure 2-9 illustrates inter-container and intra-container cable numbering.

2-70. INTRA-RACK SIGNAL PAIRS. Intra-rack signal pairs are those which interconnect equipments or components within a rack. These pairs do not leave the rack. Intra-rack pairs are numbered from PR-1 through as high a pair number as is required to accommodate all the pairs within the rack. This numbering system is used on rack wiring diagrams that are furnished for each type of rack provided.

2-71. SIGNAL CABLE RECORDS.

All signal cable and signal cable pair assignments are listed on CABLE PAIR RECORD cards which are bound in two volumes separate from this manual. The cable records provide a complete record of all installed cables and cable pair assignments of the communication system. For the convenience of maintenance personnel, the cards for the Receiving Central are bound in one volume and those for the Transmitting Central in a separate volume.

2-72. CABLE PAIR RECORD CARD. A typical CABLE PAIR RECORD card is illustrated in figure 2-10. Referring to the encircled numerals appearing on the card in figure 2-10 an explanation of the use of the card follows:

1. Cards are numbered from 1 on up for each container, intercommunication system, and clock system.
2. This is the number assigned to the cable. The cable number appears on a Tyrap or on a suitable label at each end of the cable.
3. This block indicates the number of pairs contained in the cable.
4. This block indicates where the signal cable originates.
5. This block indicates where the signal cable terminates.
6. This column lists either the pair numbers of multiple-pair cables or the cable numbers of single-pair cables.
7. This column lists equipment numbers, circuit numbers, or circuit designations of the cables or cable pairs listed in first column.
8. This column is used to indicate type of circuit (audio, DC, RF, etc.), and the service the pair or cable provides.

- 9. This heading applies to columns 10 through 14.
- 10. This column lists the rack and or elevation locator of the equipment or terminal block at which the cable or pair originates.
- 11. This column lists the terminals and the terminal board, connector, jack, or coaxicon block of the rack or equipment listed in previous column.
- 12. This column is used for color code of cable pairs or for special cable-routing instructions.

- 13. This column lists the rack and/or elevation locator number of the equipment at which the cable or pair terminates.
- 14. This column lists the terminal numbers and terminal board, connector, jack, or coaxicon connector designator of the equipment listed in previous column at which the cable or pair terminates.
- 15. The REMARKS column is used for additional information concerning a cable or cable pair, such as special instructions for signal pair grounding.

CABLE PAIR RECORD

CARD NO. ①

CABLE NUMBER(S) ②		PAIRS ③		FROM: ④		TO: ⑤			
⑥ CABLE PAIR NO.	CIRCUIT		CONNECTOR OR TERMINAL NUMBER ⑨					⑮ REMARKS	
	⑦ NUMBER OR DESIGN.	⑧ TYPE AND SERVICE	FROM:		VIA ⑫	TO:			
			EQUIP- MENT ⑩	TERMI- NALS ⑪		EQUIP- MENT ⑬	TERMI- NALS ⑭		

Figure 2-10. Cable Pair Record Card, Typical Example