

## **Service Console Elements Command Console Elements**

**5025            Microprocessor Control Card**

**5800A         Floppy/Hard Disk Controller**

**5410           VGA Video Adapter**

**Not Shown:**

**5524           2400bps Modem  
                 Event Printer  
                 VGA Display  
                 Voice/Data Multiplexer  
                 Floppy/Hard Disk  
                 AT-Style Keyboard  
                 Visual Alarm Panel**

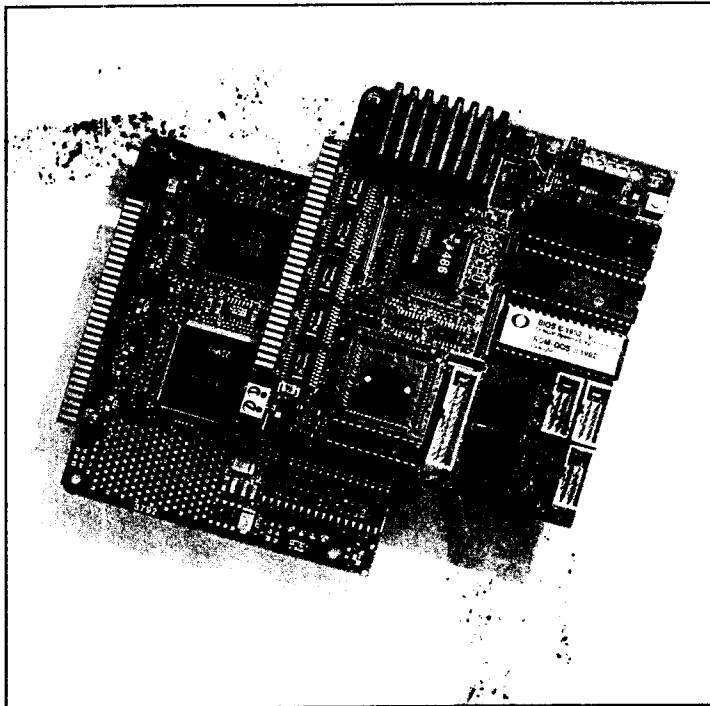

*The 5025 has PC compatible serial and parallel ports, keyboard and speaker ports, a calendar/clock option, 4 MB DRAM, DOS in ROM and three solid-state disks. Not shown are the four screw terminals for the RS-422/485 ports. Additional SSD2 sockets on back of board. (Photo shows components mounted on back of board—the 5025 is a single-card CPU.)*

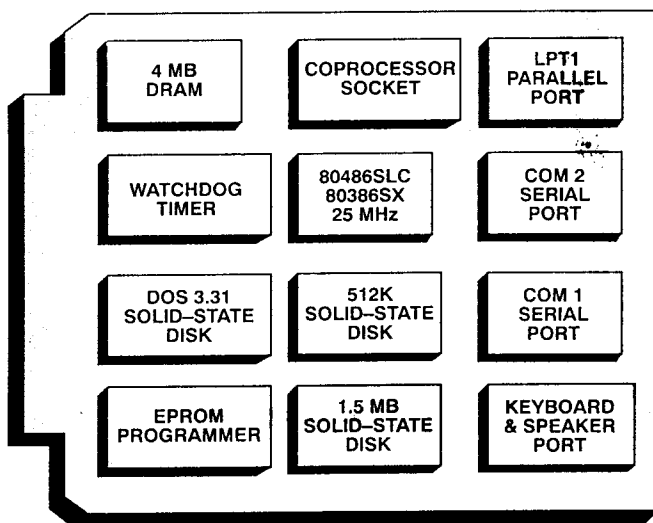

## 5025 PC CONTROL CARD

**HIGH PERFORMANCE**  
**486SLC, 25 MHZ AT**  
**386SX, 25 MHZ AT**

### FEATURES

- 40° to 85° C
- "Instant DOS" operation, DOS 3.31 included
- (3) solid-state disks
- EPROM programmer
- 4 MB DRAM
- COM 1 and COM 2 serial ports
- LPT1 parallel port
- Keyboard/speaker ports
- Calendar/clock option
- Watchdog timer
- 5V operation—all modes
- Coprocessor socket

## DESCRIPTION

The 5025 is intended for high performance, embedded control applications. Two versions are available: The 5025, which has a 25 MHz 80386SX, and the high performance 5025-486, which has twice the performance of the 5025. The 5025-486 uses the code efficient 80486SLC CPU from Cyrix and Texas Instruments. It has COM1 and COM2 serial ports, a LPT1 parallel port, a keyboard and speaker port, calendar/clock, watchdog timer, 4 MB of DRAM, DOS in ROM, coprocessor socket, and three solid-state disks. The 5V operation simplifies installation.

### Instant DOS

The 5025 is an "instant DOS" system. The card includes 3.31, compatible in a solid-state disk. The system boots and operates the same way as your desktop PC. The DOS options eliminate guesswork about how your software will run on the 5025.

### Watchdog timer

The watchdog timer resets the system if the program stops unexpectedly. The watchdog is enabled under software control. The timeout is 1.6 sec.

### Calendar/clock

The 5025 has a built-in, AT style calendar/clock. An external AT clock battery plugs into the card and powers the clock during power down.

### Solid-state disk options

SSD0 contains the BIOS and DOS 3.31 in ROM. SSD1 is used for storage of the applications program. 256K flash EPROMs may be used. The flash programmer is built-in allowing reprogramming through a serial port. Standard EPROMs up to 512K may also be used.

SSD2 is used primarily for logging process data. This disk is three sockets that accept 128K or 512K static RAMs. Up to 1.5 MB is supported. The static RAM can be battery-backed.

The solid-state disks look like floppy disks to the user. All the necessary software is provided.

### Speaker and keyboard port

The speaker and keyboard lines are brought out to a 10-pin connector via a CMA-10 cable. The PSKI-1 interface provides a PC compatible connector for the keyboard and screw terminals for the speaker. Any AT compatible keyboard may be used.

### COM1 and COM2 serial ports

COM1 and COM2 serial ports are 8250 compatible. The baud rates are programmable from 150 to 115K baud. Both ports have a RS-232 interface. RS-232 voltages are generated on-card. COM2 is also jumperable as RS-422 and RS-485 for multidrop operation.

### LPT1 parallel port

The LPT1 parallel port can be used for a printer port or for general purpose I/O. For embedded applications an interface board and software are available to interface with a 4-line LCD display and a 16-position keypad.

### Setup stored in serial EEPROM

Loss of setup data is serious in industrial applications: Typically, an AT stores its setup information in battery-backed RAM. If the battery should fail or be replaced during routine maintenance, this information is lost. In embedded applications without keyboard and monitor, time consuming reinitialization is required. The 5025 solves this problem by storing the setup information in nonvolatile EEPROM; as a result it is immune to battery or power failure.

The user can store additional information in the EEPROM: Up to 900 bytes are available; 88 bytes is standard.

## Hardware reset

You can reset the system without turning off the power by using the hardware reset button. It also provides a more complete reset than the <CTL> <ALT> <DEL> method.

## Mounting

There are three ways to mount the 5025:

1. Plug it directly into a Micro PC card cage;
2. Use the optional PC mounting bracket and plug it into any passive backplane;
3. Panel mount it using the four mounting holes. A screw terminal connector is used to supply the 5V power.

## Boot sequence

A system can execute from the on-card, solid-state disk, floppy or hard disk.

## TECHNICAL SPECIFICATIONS

### CPU

5025: 80386SX, 25 MHz  
5025-486: 80486SLC (Cyril, T.I.), 25 MHz

### BIOS

PC compatible with industrial extensions

### DOS

MS-DOS compatible  
version 3.31 supplied

### DRAM

0K, 1 MB, 2 MB, 4 MB; 80 nS with 0 wait states. See ordering information.

### EXTENDED MEMORY

Supports the LIM 4.0 standard above 640K

### SOLID-STATE DISKS

SSD 0 contains BIOS and DOS, 128K.

SSD 1 supports EPROMs to 512K with programmer for flash EPROMs to 256K; EPROMs optional.

SSD 2 supports 128K or 512K of static RAMs with optional battery-backup. Up to 1.5 MB is supported in three sockets (2 on back of card). RAM optional.

### EPROM PROGRAMMER

Programs 256K byte flash EPROM.  
Generates +12V on-card.

### SERIAL EEPROM

88 bytes available to user in standard model. Options to 900 bytes are available.

### COPROCESSOR SOCKET

Accepts 80387SX coprocessor.

### POWER SPECIFICATIONS

5025: 5V ±5% at 400 mA  
5025-486: 5V ±5% at 700 mA  
2 MB DRAM, 25 MHz

### BATTERY

The calendar clock uses a standard, AT type battery. If an external battery is used for backup of the static RAM, a connector is provided for a 3.6V lithium battery.

### ENVIRONMENTAL

-40° to 85° C operating\*  
-55° to 90° C nonoperating  
RH 5% to 95%, noncondensing

\*The 85° C is a free-standing maximum. When used in card cage, the maximum is 70° C without forced air flow.

## CONNECTOR PINOUTS

### Printer/parallel port: J5

Func.	Pin #	Func.	Pin #
Out	1	I/O 5	11
Out	2	I/O 6	12
I/O 0	3	I/O 7	13
In	4	In	14
I/O 1	5	In	15
Out	6	In	16
I/O 2	7	In	17
Out	8	Gnd	18
I/O 3	9	Gnd	19
I/O 4	10	Gnd	20

### COM1 serial: J2

### COM2 serial: J1

Funct.	Pin #	Funct.	Pin #
DCD	1	CTS	6
DSR	2	DTR	7
RxD*	3	RI	8
RTS	4	Gnd	9
TxD*	5	+5V	10

\*=active low

## ORDERING INFORMATION

#3259 5025 0K  
#3442 5025 1 MB  
#3443 5025 2 MB  
#3444 5025 4 MB  
#3485 5025-486 0K  
#3487 5025-486 1 MB  
#3488 5025-486 2 MB  
#3489 5025-486 4 MB  
#3480 DS-1213DM, battery backup for 512K RAM  
#3162 256K flash EPROM, DIP  
#1474 128K static RAM  
#3214 1 MB DRAM kit  
#3186 AT clock battery  
#2746 VTC-9F cable, serial, 9-conductor DB-9  
CMA-10-xx cable  
CMA-20-xx cable

## 5025 CONNECTION DIAGRAM

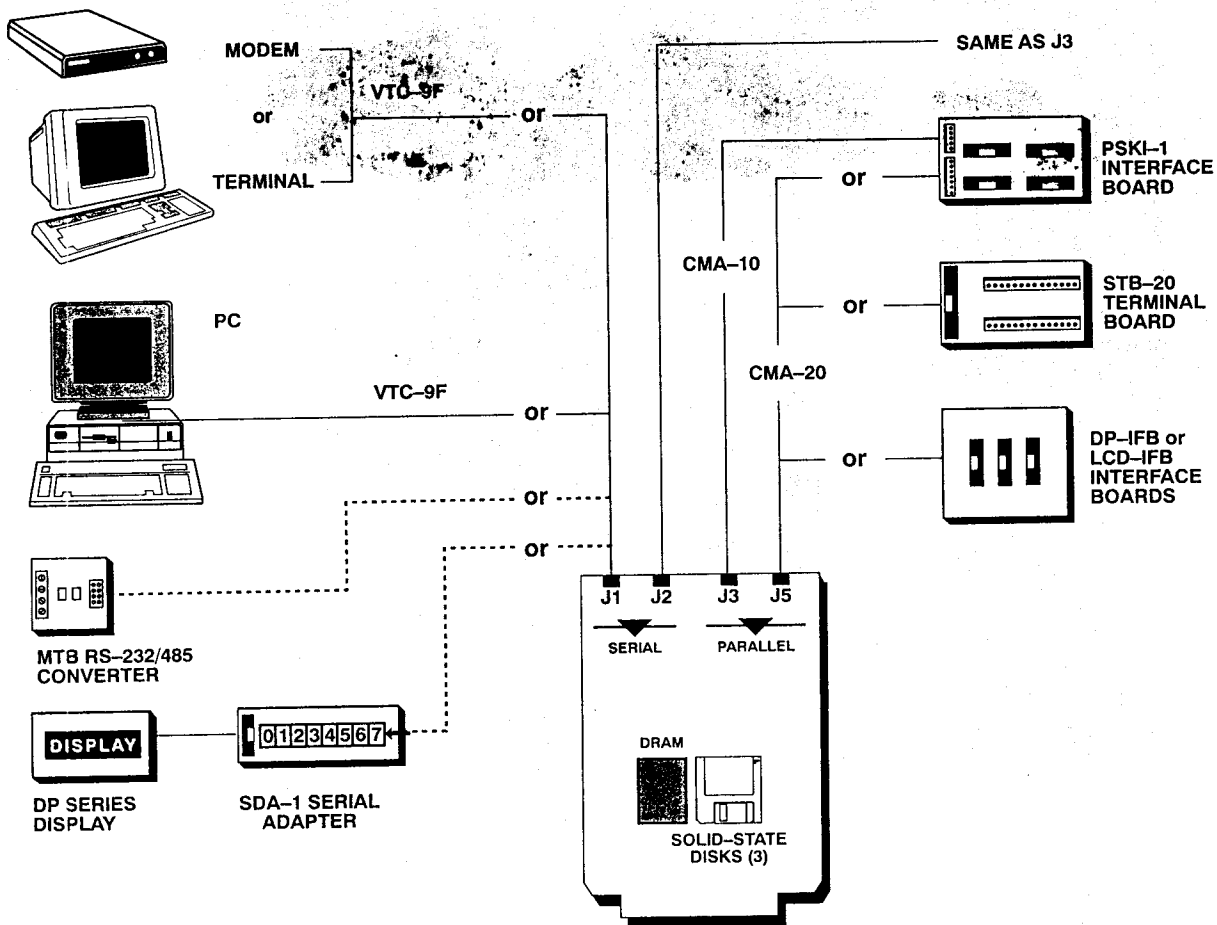

**NOTE:** Dotted lines indicate cable is included.

### OPTIONS

- DS-1213DM battery backup
- 256K flash EPROM, DIP
- 128K static RAM
- 512K static RAM
- 1 MB DRAM kit

### ACCESSORIES

- CMA-10 cable
- CMA-20 cable
- VTC-9F serial cable
- PC SmartLINK IV

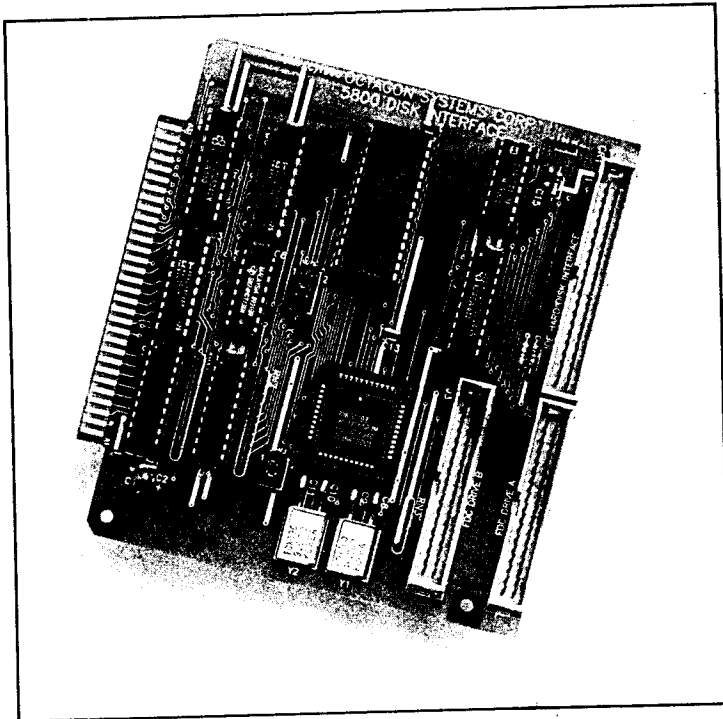

*5800A is compatible with all common floppy drives used in the PC.*

## 5800A FLOPPY AND HARD DISK CARD

### FEATURES

- -20° to 70° C
- Supports two floppy drives
- 360K and 1.2 MB, 5.25 in.
- 720K and 1.44 MB, 3.5 in.
- Supports hard disk drives up to 510 MB that have internal 16-bit IDE interfaces

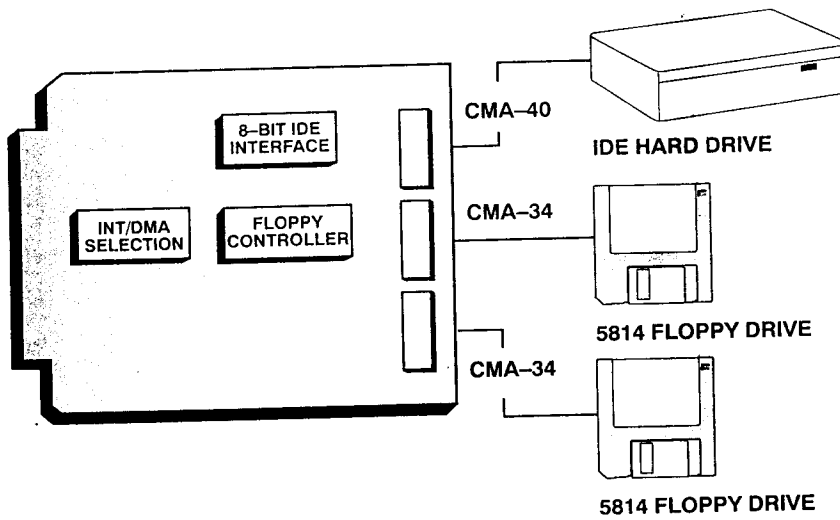

## DESCRIPTION

The 5800A is compatible with all common floppy disk drives used in the PC. There are two 34-pin connectors for the floppy drives. It will also drive up to 510 MB hard drives that have internal 16-bit IDE interfaces. The hard disk connects to the 5400 through a 40-pin connector.

The BIOS extension ROM for the hard drive is supplied on the card so that no additional software is needed. The floppy drives use DMA channel 1 and the hard drive uses DMA channel 2.

The 5800A is compatible with all PC Control Cards. It can not be used with Microcontroller cards (5080, 5081, 5082, 5083).

**NOTE:** CMA-34 is not required if the 5814 is ordered for your system.

### Access indication

The 5800A has a LED indicator that flashes briefly when the card is accessed. This is useful when debugging software.

## TECHNICAL SPECIFICATIONS

### POWER SPECIFICATIONS

5V  $\pm$ 5% at 100 mA

### ENVIRONMENTAL

-20° to 70° C operating

-40° to 85° C nonoperating

RH 5% to 95%, noncondensing

### ACCESSORIES

CMA-34 floppy cable for 3.5-in. drives

CMA-40 floppy cable for 3.5-in. drives

5814 1.44 MB, 3.5-in. floppy drive

### ORDERING INFORMATION

#3391 5800A Floppy/hard disk card

CMA-34-xx cable

CMA-40-xx cable

## 5410 VGA VIDEO CARD

### FEATURES

- -25° to 85° C
- Fully IBM VGA, EGA and CGA compatible
- Supports analog and digital video monitors and LCD, plasma and electro-luminescent panel displays
- Text enhancement improves contrast on flat panel displays
- Up to 64 gray levels on monochrome panels
- 5V operation
- See pages 114-115 for a list of displays the 5410 supports.

### DESCRIPTION

The 5410 VGA card supports a variety of video and flat panel displays. The operation is fully compatible with the IBM VGA standard.

In addition to digital and analog CRTs, the 5410 supports resolutions of 640 x 200, 640 x 350, 640 x 400, and 640 x 480 panels.

### TECHNICAL SPECIFICATIONS

**POWER SPECIFICATIONS**  
5V ±5% at 80 mA

**ENVIRONMENTAL**  
-25° to 85° C operating  
55° to 90° C nonoperating  
RH 5% to 95%, noncondensing

**ORDERING INFORMATION**  
#3153 5410 VGA video card

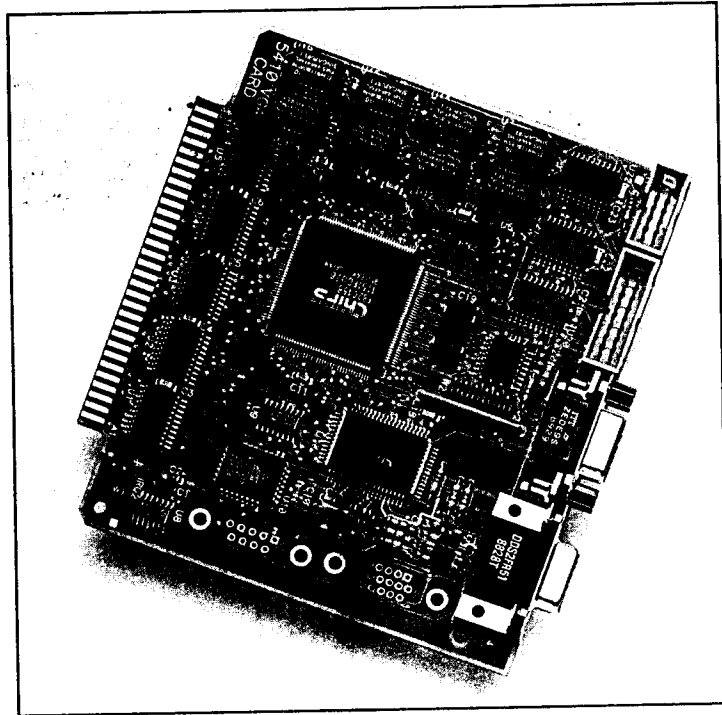

*The 5410 is fully compatible with the IBM VGA standard.*

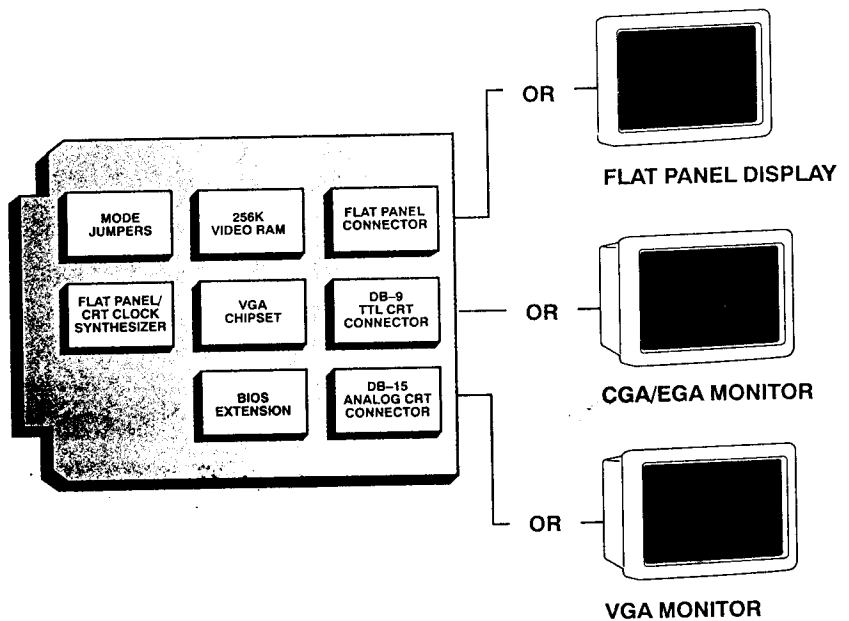





## **AX816 Processor Unit Elements**

- 6012    Microprocessor Control Card**
- 5805    Solid-State Disk, 1MB**
- 5600    Digital Input/Output**
- 5700    Analog Input/Output (13-bit)**
- 5710    Analog-to-Digital (12-bit)**
- 5610    Reed Relay**
- 5328    Motion Control (optional)**

### **Interface Boards and Modules:**

- RS-485 Multi-Drop**
- High-Voltage Interface**
- Analog Input Expansion**
- Signal Conditioning**
- Opto-Isolators**

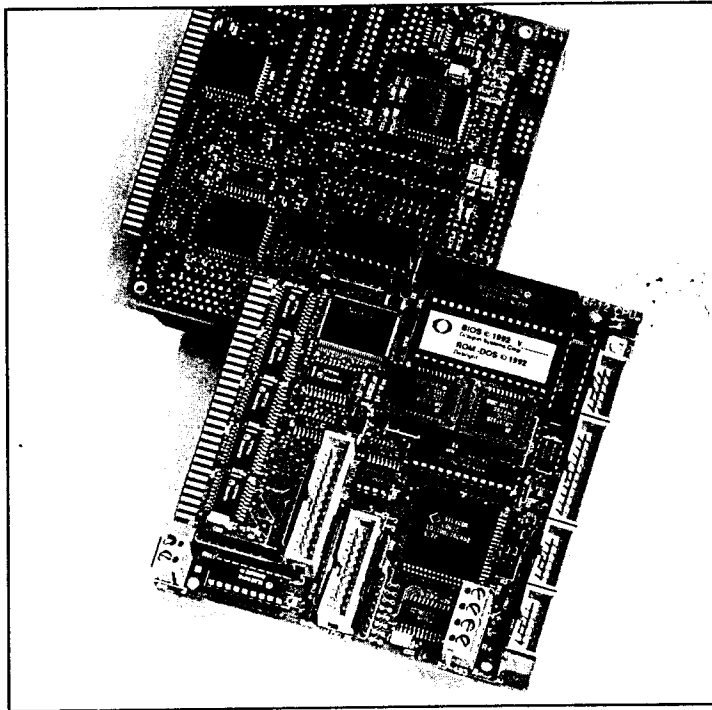

*The 6012 integrates the PC with data acquisition and process control on a single card. (Photo shows components mounted on both sides—the 6012 is a single-card CPU.)*

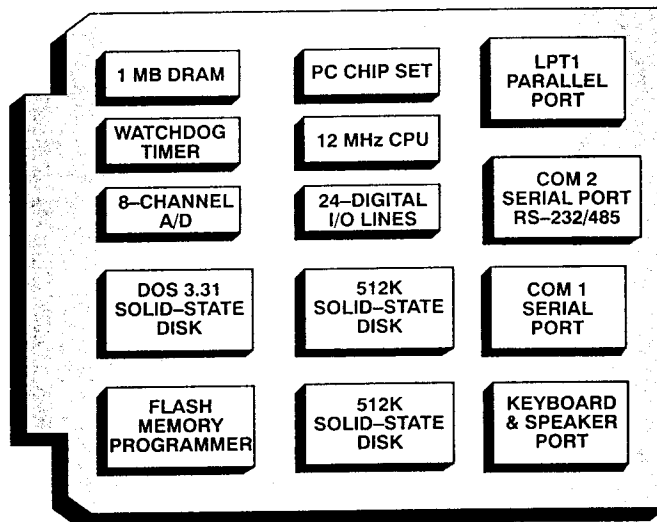

## 6012 PC CONTROL CARD

### 12 MHZ PC WITH ANALOG AND DIGITAL I/O

#### FEATURES

- -40° to 85° C
- "Instant DOS" operation, DOS 3.31 included
- (3) 512K solid-state disks
- 8 analog inputs, 12-bit A/D
- 24 digital I/O, opto rack interface
- Drives 8 high current relays, LEDs, etc.
- LCD display port
- Flash memory programmer
- 1 MB DRAM
- COM1 and COM2 serial ports
- LPT1 parallel port
- Keyboard, keypad and speaker ports
- Calendar/clock
- Stand-alone or bus operation
- Watchdog timer
- 5V operation—all modes

## DESCRIPTION

The 6012 is a cost effective solution combining a PC and data acquisition and control on the same card. The 6012 can be operated stand-alone for the lowest system cost. The card is mounted via the four corner holes, and 5V power is supplied to screw terminals. For I/O expansion the 6012 can be plugged into a Micro PC card cage.

The 6012 integrates PC architecture with two serial ports; printer, keyboard and speaker ports; a 24-line parallel port for logic I/O or for interfacing directly to an opto module rack; 8-channel A/D converter with programmable single-ended and differential inputs; calendar/clock option; 1 MB DRAM; and DOS in ROM.

### DOS operating system

The 6012 is an "instant DOS" system. The card includes a MS DOS 3.31 compatible operating system in ROM and two other solid-state disks. You program the card two ways: from your PC through the serial port; or by adding a keyboard, monitor, floppy drive and drive cards. Since your program is stored in ROM, it is always present on power-up. During run time it requires only about 17K of RAM space.

### Watchdog timer

The watchdog timer resets the system if the program stops unexpectedly. The watchdog is enabled under software control. The timeout is 1.6 sec.

### Calendar/clock

The DS-1216 series offers a battery-backed calendar/clock option that contains a 99-year calendar. Time can be set and read in a 24-hr. format with a resolution of 0.01 sec. The clock plugs into a solid-state disk socket and contains its own dual, lithium battery system with a minimum life of five years. A driver is built into the BIOS to handle all the clock functions required by DOS.

### Solid-state disk options

In addition to the solid-state disk with DOS, the 6012 has sockets for two more solid-state disks. The boot disk (SSD1) accepts one or two 256K flash memories. The data disk (SSD2) accepts a 128K or 512K static RAM.

The SSD1 socket normally contains the program to be executed on power-up. The program is automatically loaded into DOS memory and executed.

A program residing in memory can be transferred into the flash memory using the on-card programmer and supplied software. Only flash EPROMs may be programmed. These devices are erased automatically during the programming process. Multiple programs may be stored as long as the total size does not exceed 512K.

The SSD2 socket will only accept a static RAM. To retain data during power outage, the DS-1216DM can be used with the 128K or 512K RAM. The DS-1216DM also provides the calendar/clock function.

The solid-state disks reside in memory that is separate from the 640K of DOS memory. Software drivers are provided.

### **Programmable analog inputs**

There are eight channels that have software programmable modes and input voltage ranges. The mode of a channel may be single-ended or differential. Adjacent channels are used for the other differential input. A maximum of four differential channels may be configured. The input ranges are software programmable for 0–5V or  $\pm 5V$ . The resolution is 12 bits on both ranges. The span is adjustable so that an overrange can be detected.

The A/D converter includes sample-and-hold circuitry to freeze the input value while conversion is taking place. Throughput is 12,000 samples/sec. in burst mode and 6,000 samples/sec. in the one-shot mode. The input impedance is 1 M $\Omega$ . Voltages as high as  $\pm 16V$  will not damage the converter; however, valid operation requires that the input voltage remain within the standard ranges. The input connections are terminated with a 20-pin IDC connector that is compatible with the STB-20 and ATB-20 terminal boards.

### **Digital I/O port and opto rack interface**

The 24 digital I/O lines will interface with logic devices, switch inputs, LEDs and industry standard opto module racks. The I/O lines are 0–5V logic compatible. They can be programmed as inputs or outputs in groups of four and eight lines.

### **High current interface**

Eight of the 24 I/O digital i/O lines can also drive external devices that require up to 100 mA per device, and up to a 50V power supply. Relays, small motors, displays and other devices can be driven directly by the 6012. The outputs act as switches to ground. The eight lines can be converted to 0–5V logic levels with a supplied jumper block.

### **Matrix keypad and LCD display support**

The LPT1 parallel port can interface with a matrix keypad with 12 or 16 keys, and with 2- or 4-line LCD displays. The card is supplied with a software library that provides keypad scanning and display operation and which can be linked into your C and QuickBASIC programs. If this port is used for a printer, then, the digital I/O port can also be used for the keypad and display interface. The LCD-IFB interface board provides a convenient interface for the keypad and display to the 6012.

### **Speaker and keyboard**

The speaker and keyboard lines are brought out to a 10-pin connector via a CMA-10 cable. The PSKI-1 interface provides a PC compatible connector for the keyboard, and screw terminals for the speaker. Any XT compatible keyboard may be used.

A keyboard and monitor are not required for operation. A serial terminal can be used as the keyboard and monitor.

### **COM1 and COM2 serial ports**

The COM1 and COM2 serial ports are 8250 compatible. The baud rates are programmable to 56K baud. The serial interface is RS-232C and is compatible with the VTC-9F cable.

### LPT1 parallel port

The parallel printer port can be used to support a number of devices:

1. A PC compatible printer
2. 17 digital I/O lines
3. A matrix keypad
4. 2- and 4-line LCD displays.

This port has a 20-pin connector. When used only for digital I/O, a CMA-20 cable connects the port to the STB-20 terminal board for connection to field wiring.

To use a PC compatible printer, connect this port to the PSKI-1 interface board with a CMA-20 cable. The PSKI-1 has a DB-25 connector for the printer.

This port will also interface with displays and keypads. For LCD displays use the LCD-IFB interface board, and the DP-IFB interface board for the DP displays. Both interface boards have keypad connectors. A CMA-20 cable is required.

### Setup stored in EEPROM

Loss of setup data is serious in industrial applications. Most PCs store setup information in battery-backed RAM. If the battery should fail or be replaced during routine maintenance, this information is lost. In embedded applications without keyboard and monitor, time consuming reinitialization is required. The 6012 solves this problem by storing the setup information in nonvolatile EEPROM, and as a result, the information is immune to battery or power failure.

The user can store additional information in the EEPROM: Up to 900 bytes are available; 88 bytes are standard.

### Hardware reset

You can reset the system without turning off the power using the hardware reset button. It also provides a more complete reset than the <CTL> <ALT> <DEL> method.

### Write it, ROM it, run it

You can get your program up and running on the 6012 in two quick steps. All software is included. Once you've written your program:

1. Transfer your application program to the 6012 over a serial port;
2. Store your program on the solid-state disk using the built-in software.

### Boot sequence

A system can execute from the on-card solid-state disk, floppy or hard disk.

## TECHNICAL SPECIFICATIONS

**CPU**  
V20, 80C88 compatible

**CLOCK**  
12 MHz, also software selectable for 4.77 MHz

**BIOS**  
PC compatible with industrial extensions

**DRAM**  
0K or 1 MB; 80 nS; 0 wait state; supports the LIM 4.0 standard above 640K.

**SOLID-STATE DISKS**  
SSD0 contains the BIOS and DOS 3.31

SSD1 supports one or two 256K flash EPROMs for application programs. Programmer built-in. EPROMs not included.

SSD2 supports 128K/512K static RAMs that may be battery-backed. RAM and battery not included.

Serial EEPROM 88 bytes available to user in standard model. Options to 900 bytes are available.

**PRINTER PORT**  
Standard Centronics/IBM parallel port. Data lines are bi-directional. 24 mA drive capability.

**SERIAL PORTS**  
8250 compatible UARTs; interface is standard RS-232D. Serial voltages generated on card.

**PARALLEL PORT**  
24 lines programmable as inputs or outputs in groups of 4 or 8. 0-5V voltage levels. Source and sink current 2.5 mA for logic interface. Sink current is 12 mA when driving opto module racks. All lines have 10K pull-up resistor.

8 of the 24 lines above will also drive loads as high as 100 mA and 50V. This is the default. These 8 lines can be converted to standard 0-5V I/O with a supplied jumper block.

This port is terminated with a 26-pin IDC connector.

#### ANALOG INPUT

8 channels, 1MΩ input impedance, programmable for 0-5V or ±5V for each channel, sample-and-hold on + inputs, damage protected to ±16V, full scale adjustable for overrange detection.

Input voltage must not exceed the full scale rating by more than 50 mV for normal operation.

Adjacent channels may be software configured for differential inputs.

Resolution is 12 bits on both ranges. Linearity is 0.025%. An adjustable precision reference provides the full scale value. Tempco is 20 PPM. Zero offset is not adjustable and has a typical value of 1.5 counts.

This port is terminated with a 20-pin IDC connector.

#### POWER SPECIFICATIONS

5V ±5% at 230 mA (1 MB DRAM), 350 mA during flash memory programming

#### ENVIRONMENTAL

-40° to 85° C operating  
-55° to 90° C nonoperating  
RH 5% to 95% noncondensing

#### ORDERING INFORMATION

#3497 6012 0K  
#3476 6012 1 MB  
#3042 DS-1216DM, calendar/clock for 512K static RAM  
#3495 256K flash EPROM, PLCC  
#1274 128K static RAM  
#2915 512K static RAM  
#2746 VTC-9F serial cable  
CMA-10-xx cable  
CMA-20-xx cable  
CMA-26-xx cable

### CONNECTOR PINOUTS

Printer/parallel port: J2		
Funct.	Pin #	Dir.
STB*	1	In/out
AFD*	2	In/out
Data 0	3	In/out
ERR*	4	In
Data 1	5	In/out
INIT*	6	In/out
Data 2	7	In/out
SLIN*	8	In/out
Data 3	9	In/out
Data 4	10	In/out
Data 5	11	In/out
Data 6	12	In/out
Data 7	13	In/out
ACK*	14	In
Busy	15	In
PE	16	In
SLCT	17	In
+5V	18	Out
Gnd	19	Out
Gnd	20	Out

#### COM1 serial port: J4

#### COM2 serial port: J3

Funct.	Pin #	Dir.
DCD	1	In
DSR	2	In
RxD	3	In
RTS	4	Out
TxD	5	Out
CTS	6	In
DTR	7	Out
RI	8	In
Gnd	9	Out
+5V	10	Out

#### Analog port: J5

Funct.	Pin #	Funct.	Pin #
Input 0	1	Input 5	11
Gnd	2	Gnd	12
Input 1	3	Input 6	13
Gnd	4	Gnd	14
Input 2	5	Input 7	15
Gnd	6	Gnd	16
Input 3	7	NC	17
Gnd	8	NC	18
Input 4	9	NC	19
Gnd	10	NC	20

#### Digital I/O port: J8

I/O line	Port A	Port B	Port C
Line 0	19	10*	13
Line 1	21	8*	16
Line 2	23	4*	15
Line 3	25	6*	17
Line 4	24	1*	14
Line 5	22	3*	11
Line 6	20	5*	12
Line 7	18	7*	9
+5V—Pin 2			
Gnd—Pin 26			

\* These lines are also high current.

## 6012 CONNECTION DIAGRAM

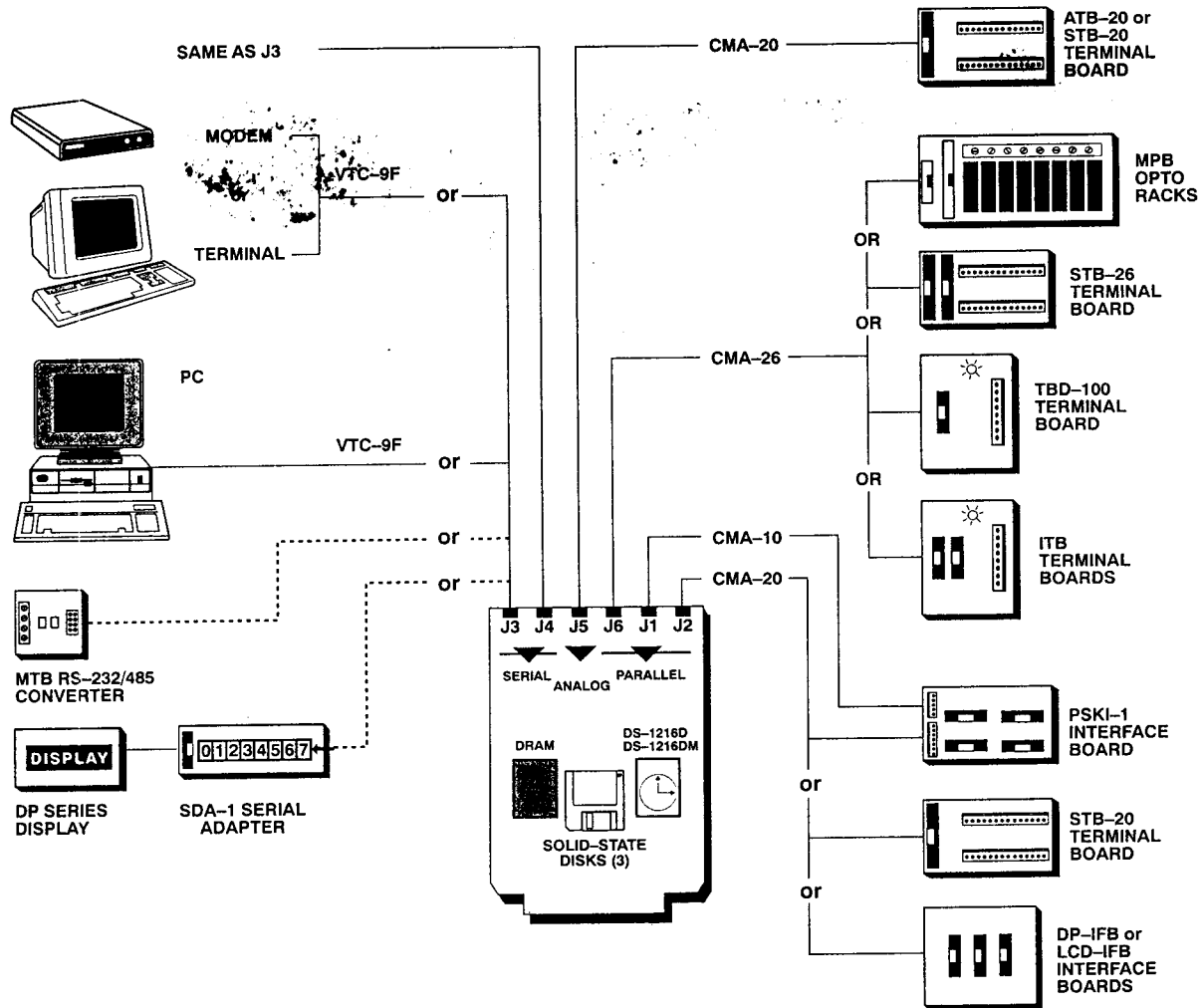

**NOTE:** Dotted lines indicate cable is included.

### OPTIONS

- DS-1216DM calendar/clock
- 256K flash EPROM, PLCC
- 128K static RAM
- 512K static RAM
- 1 MB DRAM kit

### ACCESSORIES

- CMA-10 cable
- CMA-20 cable
- CMA-26 cable
- VTC-9F serial cable
- PC SmartLINK IV

## DESCRIPTION

The 5805 solid-state disk card can be used to save data or programs in nonvolatile memory. The card is jumpered either for use as a battery-backed RAM disk or as a ROM disk. It accepts eight 128K static RAMs or EPROMs.

The static RAM contents are protected by an automatic battery-backup system. The battery life is a minimum of five years.

PC Control Cards see the 5805 as a floppy disk drive. The 5805 can be assigned any drive designator. It can be used to store programs and automatically boot on power up. Programs can be downloaded through a serial port and then saved on the 5805.

The 5805 is also an ideal storage device for data logging or saving process data. You can use as many 5805s as there is space available in the card cage. It is I/O mapped and does not occupy any of the system memory space.

The 5805 comes unpopulated. Memory ICs may be added as needed up to the 1 MB capacity. The card is either RAM-only or ROM-only; IC types may not be mixed.

It is supported by ROM-DOS on the PC Control Cards; both programs and data may be stored. Microcontroller cards can also use the 5805 for data storage. However, the 5805 is accessed as an I/O device in CAMBASIC IV, since the language does not contain a disk operating system.

### Card address selection

The 5805 has jumpers to select one of eight I/O address blocks. Multiple cards can be used in the same system.

### Software library

Software drivers are supplied.

## TECHNICAL SPECIFICATIONS

### MEMORY SOCKETS

Eight 32-pin for static RAMs or EPROMs

### MEMORY DEVICE TYPE

128K static RAM, low power  
128K EPROM

### MEMORY ACCESS TIME

200 nS, or faster

### DATA TRANSFER RATE

Limited by CPU speed

### WRITE-PROTECT SWITCH

Prevents accidental overwrite of data

### ACCESS LED

A LED lights briefly each time the disk is accessed.

### WRITE-PROTECT LED

A LED lights when the disk is write-protected.

### BATTERY

3.6V, 1 AH, Lithium. 5-year life minimum with low-power memory. The battery is replaceable.

### POWER SPECIFICATION

5V  $\pm$ 5% at 35 mA

### ENVIRONMENTAL

-40° to 85° C operating  
-55° to 90° C nonoperating  
RH 5% to 95%, noncondensing

### OPTIONS

128K static RAM  
128K EPROM

### ORDERING INFORMATION

#2650 5805 1 MB solid-state disk card  
#1474 128K static RAM  
#2651 128K EPROM



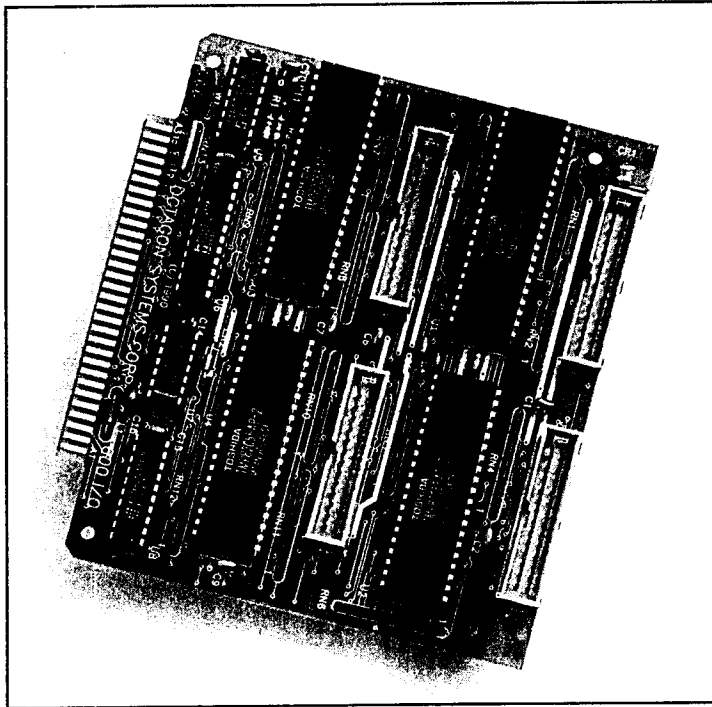

The 5600 and 5600-48 will interface with most types of parallel ports, LCD and DP displays, and single LEDs.

## 5600 DIGITAL I/O CARDS

### FEATURES

- -40° to 85° C
- 96 I/O lines, 5600
- 48 I/O lines, 5600-48
- Compatible with standard logic level devices
- Directly drives up to 4 opto module racks
- Accepts switch closures
- Drives LEDs directly
- Drives parallel displays
- 5V operation

### DESCRIPTION

The 5600 and 5600-48 accept switch closures and logic inputs, drives displays and LEDs, and interfaces with opto module racks. Each I/O line has a 10K pull-up resistor so that external resistors are not required when using switch contacts.

The 5600 will interface with most types of parallel ports, LCD and DP displays, and single LEDs. The I/O levels are 0-5V and are compatible with logic levels. For field wiring termination, see the diagram on this page.

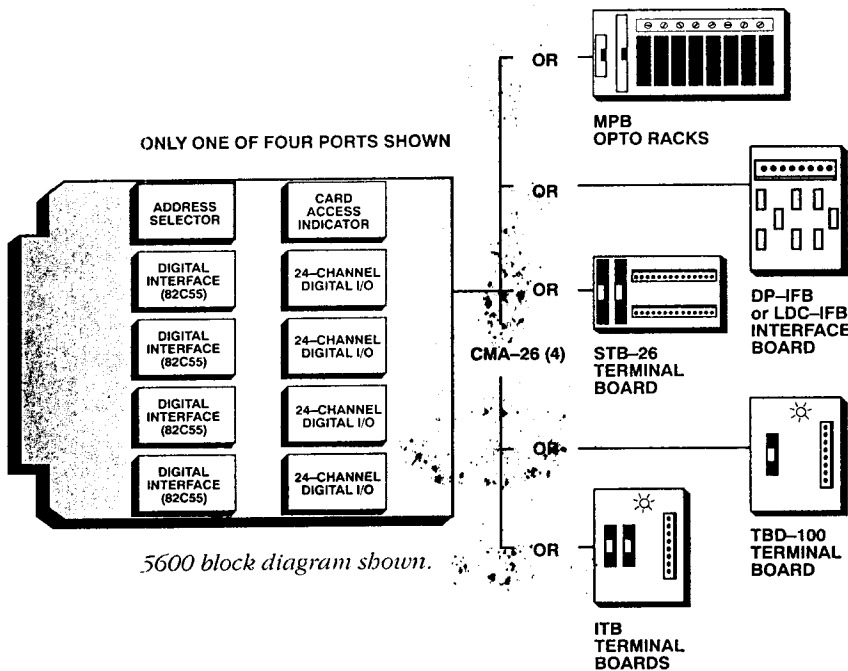

### Driving opto racks

The 5600 can also drive up to four of the MPB-xx series opto module racks. The isolator modules are used when driving high currents or receiving high voltages. Opto-isolation also eliminates ground loops and significantly reduces the chance that noise will invade the system. The MPB-xx series interfaces to the 5600 via a CMA-26 cable

### Driving displays

Adapters are available for driving DP and LCD series displays. Software drivers are available. You can also drive nearly any parallel display.

### I/O organization

The 96 I/O lines on the 5600 are organized into four identical connector groups. Each connector group has two 8-bit ports and two 4-bit ports. Each port may be programmed as an input or output. The 5600 uses a high drive version of the 82C55.

The 48 I/O lines on the 5600-48 are organized into two identical connector groups. Each connector group has two 8-bit ports and two 4-bit ports. Each port may be programmed as an input or output.

### Access indication

The 5600 has a LED indicator that flashes briefly when the card is accessed. This is useful when debugging software.

### Card address selection

The 5600 has jumpers to select one of eight I/O address blocks. Multiple cards can be used in the same system.

### Software library

Software drivers are available in QuickBASIC, C and PASCAL. See page 12.

## TECHNICAL SPECIFICATIONS

### INPUT VOLTAGE LEVEL

#### 0-5V

0.0-0.8V is a logic zero  
2.0-5.0V is a logic one

### OUTPUT VOLTAGE LEVEL

#### 0-5V

0.0 to 0.4V is a logic zero  
3.0 to 5.0V is a logic one  
(Logic interface)

0.0-1.0V opto module on  
2.4-5.0V opto module off  
(opto mounting rack)

### OUTPUT CURRENT

2.5 mA logic interface  
12 mA opto mounting rack

### POWER SPECIFICATIONS

5V  $\pm$ 5% at 35 mA all input lines (high)  
5V  $\pm$ 5% at 75 mA all output lines (low)

### ENVIRONMENTAL

-40° to 85° C operating  
-55° to 90° C nonoperating  
RH 5% to 95%, noncondensing

### ACCESSORIES

CMA-26 cable

### ORDERING INFORMATION

#2536 5600 Digital I/O card  
#3336 5600-48 Digital I/O card  
CMA-26-xx cable

## CONNECTOR PINOUTS

Digital I/O port: J1, J2, J3, J4			
I/O line	Port A	Port B	Port C
Line 0	19	10*	13
Line 1	21	8*	16
Line 2	23	4*	15
Line 3	25	6*	17
Line 4	24	1*	14
Line 5	22	3*	11
Line 6	20	5*	12
Line 7	18	7*	9
+5V—Pin 2			
Gnd—Pin 26			

\* These lines are also high current.

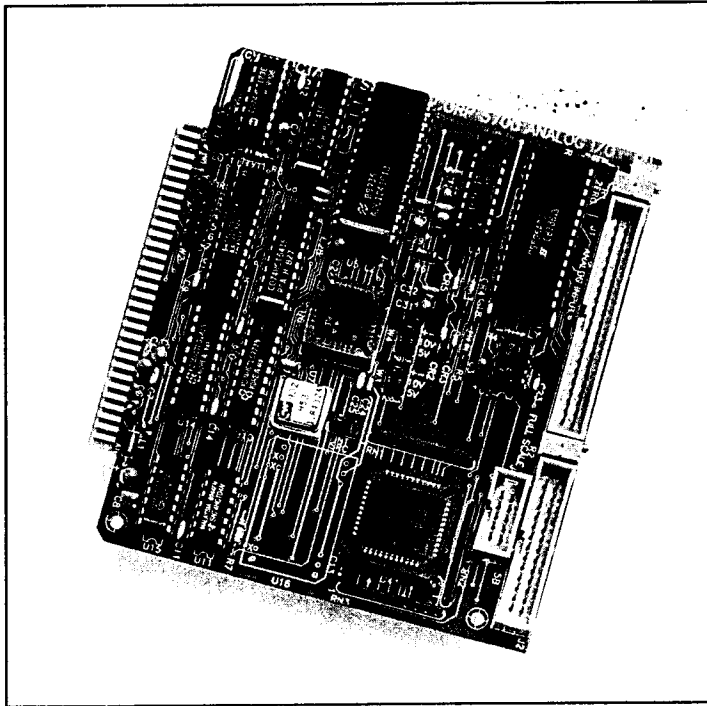

The 5700 is an autocalibrating analog I/O card.

## 5700 13-BIT ANALOG I/O CARD

### FEATURES

- -40° to 85° C
- 16 analog input channels
- 13-bit, 12 bits plus sign
- Programmable gains of 1, 10 and 100
- Auto zero
- Auto calibrate
- Sample and hold
- 15  $\mu$ S conversion time
- 50,000 samples/sec.
- 24 digital I/O lines
- 5B module interface
- 2 analog output channels

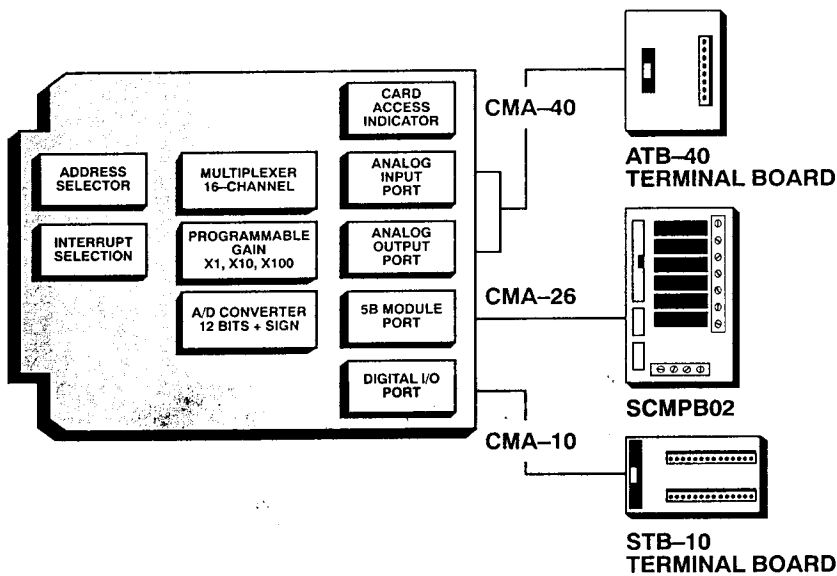

## DESCRIPTION

The 5700 is a combination analog and digital I/O card. All analog features, such as autozero, autospan and gains, are programmable through software. The card also supports thermocouples, RTDs, current loops and other I/O via the 5B series modules. There are also up to 24 digital I/O lines that can be programmed as inputs or outputs in groups of four.

### Analog input section

The 5700 has 16 single-ended channels with a resolution of 13 bits (12 bits plus sign). The input range is  $\pm 5V$ . The channels are multiplexed under software control. The inputs are protected from overload up to  $\pm 15V$  even when the power is off.

Autozero and autocalibration (span) may be performed at any time with a software command. This is useful where extreme accuracy is required over a wide temperature range. An input amplifier is software programmable with gains of 1, 10 and 100 so that the full scale input can be  $\pm 50$  mV,  $\pm 500$  mV or  $\pm 5V$ .

The 5700 has a throughput of 50,000 samples per second. A conversion takes place by a command from a Control Card.

The analog inputs are terminated with a 40-pin connector. This connector may be used with the ATB-40 terminal board for interfacing with field wiring.

### Analog output section

The two analog output channels have 12 bits of resolution. Each channel may be jumpered for output ranges of 0-5V, 0-10V and  $\pm 5V$ . The outputs remain constant until you write to them again. The throughput is 80,000 samples per second.

### 5B module port

This port interfaces with the SCMPB02 analog I/O rack for the 5B signal conditioning modules (see page 70). These modules allow thermocouple, RTD, current loop and voltages to have 1,500V of isolation from both the system and each other.

Each SCMPB02 rack holds 16 modules and up to four racks may be daisy-chained. The modules on the SCMPB02 racks are multiplexed into analog channel 15 leaving channels 0-14 for other uses. This port requires a CMA-26 cable to interface with the SCMPB02 rack.

If the 5B modules are not used, the 16 digital I/O lines at this port may be used for other purposes. In this case the only the STB-26 terminal board terminates field wiring.

See page 115 for the addresses and phone numbers of 5B module manufacturers. The 5B modules are not available directly from Octagon.

### Digital I/O port

The 5700 has 24 digital I/O lines that can be used for general purpose inputs and outputs. Two groups of eight lines can be used for the 5B port as described above, or kept available for other uses. Each group of eight may be programmed as inputs or outputs. Another group of eight lines may be programmed as inputs or outputs in groups of four.

This port is terminated with a 10-pin connector. A CMA-10 cable may be used to connect a STB-10 terminal board for interfacing field wiring.

### Interrupts

There are two interrupt sources that can be enabled through jumpers. The first is the interrupt from the A/D converter. The second is bit 0 of the digital I/O. This is useful to synchronize the A/D converter to an external event. The interrupt source can be jumpered to IRQ2 through IRQ7.

### Access indication

The 5700 has a LED indicator that flashes briefly when the card is accessed. This is useful when debugging software.

### Card address selection

The 5700 has jumpers to select one of eight I/O address blocks. Multiple cards can be used in the same system.

### Software library

Software drivers are available in QuickBASIC, C and PASCAL.

## TECHNICAL SPECIFICATIONS

### DIGITAL I/O

Type: 82C55 (special version)  
 Logic low input: 0.0–0.8V  
 Logic high input: 2.0–5.0V  
 Pull-up resistor: 10K  
 Logic low output: 0.0–0.8V  
 Logic high output: 2.4–5.0V  
 Output current: 5 mA

### ANALOG INPUT

Channels: 6 single ended  
 Input range:  $\pm 5.000V$   
 Overload protection:  $\pm 15V$  without damage  
 Input impedance: 1 M $\Omega$   
 Conversion time: 15  $\mu s$   
 MUX settling time: 5  $\mu s$   
 Throughput: 50,000 per second

### ANALOG OUTPUT

Channels: 2  
 Output ranges: 0–5V, 0–10V and  $\pm 5V$   
 Output current: 5 mA  
 Throughput: 80,000 samples per second

### POWER SPECIFICATIONS

5V  $\pm 5\%$ , 20 mA

### ENVIRONMENTAL

–40° to 85° C operating  
 –50° to 90° C nonoperating  
 RH 5% to 95%, noncondensing

### ACCESSORIES

CMA–10 cable  
 CMA–26 cable  
 CMA–40 cable

### ORDERING INFORMATION

#2611 5700, 12-bit analog I/O card  
 CMA–10–xx cable  
 CMA–26–xx cable  
 CMA–40–xx cable

## CONNECTOR PINOUTS

### Analog connector: J1

Func.	Pin #	Func.	Pin #
IN 0	1	IN 10	21
AGnd	22	AGnd	22
IN 1	33	IN 11	23
AGnd	4	AGnd	24
IN 2	5	IN 12	25
AGnd	6	AGnd	26
IN 3	7	IN 13	27
AGnd	8	AGnd	28
IN 4	9	IN 14	29
AGnd	10	AGnd	30
IN 5	11	IN 15	31
AGnd	12	AGnd	32
IN 6	3	OUT 0	33
AGnd	14	AGnd	34
IN 7	5	OUT 1	35
AGnd	16	AGnd	36
IN 8	17	+12V	37
AGnd	18	AGnd	38
IN 9	19	–12V	39
AGnd	20	AGnd	40

### Analog I/O backpanel: J2

Func.	Pin #	Func.	Pin #
VRD	1	W1	14
IO COM	2	W2	15
VWR	3	W3	16
NC	4	W4	17
IO COM	5	W5	18
IO COM	6	NC	19
R0	7	WEN*	20
R1	8	NC	21
R2	9	Reserved	22
R3	10	NC	23
R4	11	NC	24
R5	12	D COM	25
W0	13	D COM	26

### Digital I/O connector: J3

Function	Pin #
I/O 0, INT 0	1
I/O 6	2
I/O 5	3
I/O 1	4
I/O 2	5
I/O 4	6
I/O 7	7
I/O 3	8
+5V	9
Gnd	10

## 5710 LOW-COST 12-BIT A/D CARD

### FEATURES

- -40° to 85° C
- 16 S.E., 8 diff. input channels
- 12 bits resolution
- Gains of 1, 10 and 100
- Sample and hold
- 70,000 samples/sec (5710-1)
- (3) 16-bit counter/timers
- 19 digital I/O lines
- 5V operation

### DESCRIPTION

The 5710 is a high resolution, low-cost analog and digital I/O card. The analog section is capable of 70,000 conversions per second. Conversions can be initiated either by a Control Card or by using the counter/timer to log data as a background task. The counter/timers can also be used for general purpose counting and signal generation.

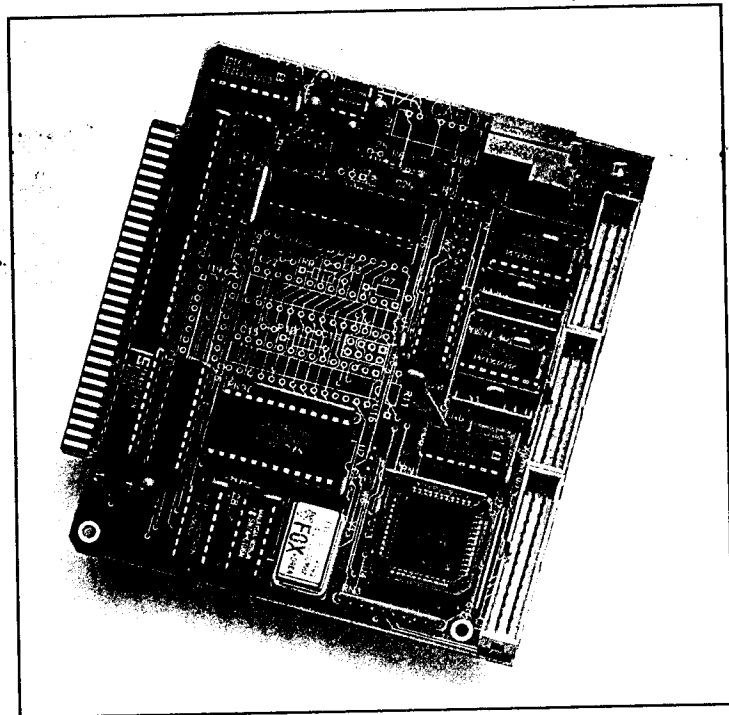

*The 5710 is a low-cost, high resolution analog card.*

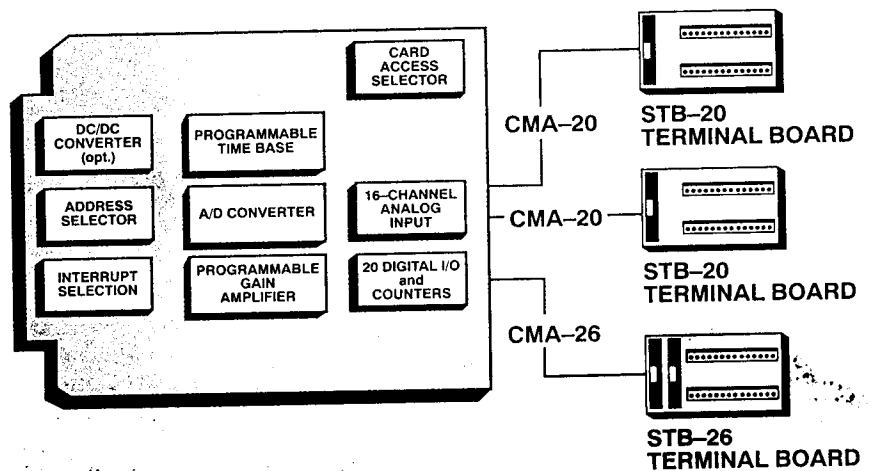

### **Analog input section**

The 5710 has 16 single-ended or eight differential channels. A jumper determines the input mode. It is the same for all channels. The resolution is 12 bits and the input range is  $\pm 5V$ . The channels are multiplexed under software control. The inputs are protected from overload up to  $\pm 15V$  even when the power is off. An amplifier is jumper programmable for gains of 1, 10 and 100 so that the full scale input can be  $\pm 50$  mV,  $\pm 500$  mV or  $\pm 5V$ .

The 5710 has a throughput of 33,000 samples per second while the 5710-1 model has a 70,000 samples per second throughput. The A/D converter is AD574/774 compatible, so existing software drivers may be used with the 5710.

An A/D conversion takes place either on a command by a Control Card or by periodically using one of the counter/timer channels. The converter may be polled for the result, or an interrupt may be generated. The A/D interrupt output may be jumpered to IRQ2 through IRQ7.

The analog inputs are terminated with two 20-pin connectors. Each connector has eight single-ended or four differential channels. The connectors have a standard pinout that assures compatibility with accessories using CMA-20 cables. You may also use the STB-20 or ATB-20 terminal boards.

### **Digital I/O**

There are 19 digital I/O lines. They are arranged in three groups. One group of three lines is outputs only. Another group of eight lines may be either inputs or outputs in groups of four. The third group of eight lines may be inputs or outputs as a group. The digital I/O may be directly connected to an opto rack for interface with high current AC and DC voltages.

These lines are terminated with a 26-pin connector with a standard pinout for compatibility with all accessories. A CMA-26 cable connects the 5710 to fielding wiring for accessories like the STB-26 terminal board.

### **Counter/timer**

There are three high speed, 16-bit counter/timers. The first counter/timer section divides a 4 MHz oscillator output. The divide ratio and countdown function are software programmable. A second section is used to further divide the frequency of the first section to provide periodic triggering of the A/D converter. The range is 40,000 triggers per second down to 3 per hour.

The last counter/timer section has its input, output and control lines terminated at the digital I/O port. This section may be used independently of the other features on the card. The input may also be jumpered to the 4 MHz clock.

### **Access Indication**

The 5710 has a LED indicator that flashes briefly when the card is accessed. This is useful when debugging software.

### **Card address selection**

The 5710 has jumpers to select one of eight I/O address blocks. Multiple cards may be used in the same system.

### **Software library**

Software drivers are available in QuickBASIC, C and PASCAL. See page 12.

## TECHNICAL SPECIFICATIONS

### DIGITAL I/O

Type: 82C55

Logic low input: 0.0–0.8V

Logic high input: 2.0–5.0V

Pull-up resistor: 10K

Logic low output: 0.0–0.8V

Logic high output: 2.4–5.0V

Output current: 5 mA

Opto rack interface: Drives 12 mA modules

### ANALOG INPUTS

Type: AD574 compatible

Channels: 16 single-ended  
8 differential

Input range:  $\pm 5.000V$

Overload protection:  $\pm 15V$  without damage

Input impedance: 0 M $\Omega$  minimum

Conversion time: 25  $\mu S$  8.5  $\mu S$  (5710–1)

MUX settling time: 4  $\mu S$

Throughput: 33,000 per second

70,000 per second (5710–1)

Counter/timer:

Type: 82C54 (enhanced 8253)

Logic low input: 0.0–0.8V

Logic high input: 2.0–5.0V

Pull-up resistor: 0K

Logic low output: 0.0–0.8V

Logic high output: 2.4–5.0V

Output current: 5 mA

Accumulator: 16-bit (3)

Count rate: 8 MHz maximum

### POWER SPECIFICATIONS

5V  $\pm 5\%$ , 70 mA

### ENVIRONMENTAL

–40° to 85° C operating

–50° to 90° C nonoperating

RH 5% to 95%, noncondensing

### ACCESSORIES

CMA–20 cable

CMA–26 cable

### ORDERING INFORMATION

#3157 5710 12-bit analog card

#3181 5710–1 High speed A/D card

CMA–20–xx cable

CMA–26–xx cable

## CONNECTOR PINOUTS

### Digital I/O port: J1

I/O line	Port A	Port B	Port C
Line 0	19	10	13
Line 1	21	8	16
Line 2	23	4	15
Line 3	25	6	17
Line 4	24	1	14
Line 5	22	3	11
Line 6	20	5	12
Line 7	18	7	9
+5V—Pin 2			
Gnd—Pin 26			

### Analog connector: J2

Func.	Pin #	Func.	Pin #
IN 0/0+	1	IN 5/4–	11
Gnd	2	Gnd	12
IN 1/0–	3	IN 6/6+	13
Gnd	4	Gnd	14
IN 2/2+	5	IN 7/6–	15
Gnd	6	Gnd	16
IN 3/PC–	7	Reserved	17
Gnd	8	NC	18
IN 4/4+	9	Reserved	19
Gnd	10	NC	20

### Analog connector: J3

Func.	Pin #	Func.	Pin #
IN 8/8+	1	IN 13/13–	11
Gnd	2	Gnd	12
IN 9/8–	3	IN 14/14+	13
Gnd	4	Gnd	14
IN 10/10+	5	IN 15/14–	15
Gnd	6	Gnd	16
IN 11/10–	7	Reserved	17
Gnd	8	NC	18
IN 12/12+	9	Reserved	19
Gnd	10	NC	20



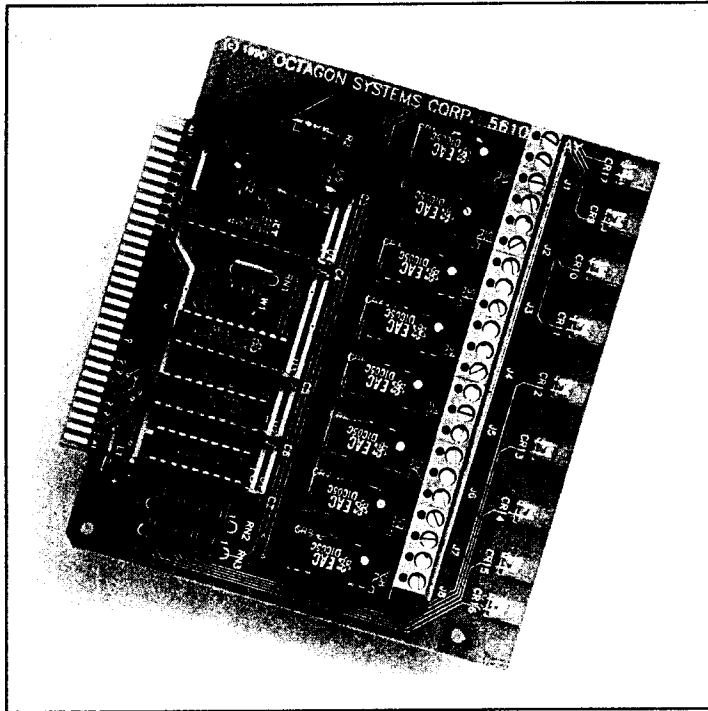

*SPDT and SPST relays are socketed and field-replaceable.*

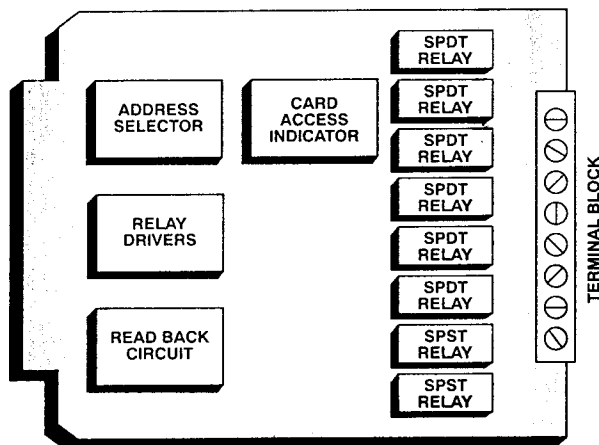

## 5610 REED RELAY CARD

### FEATURES

- $-40^{\circ}$  to  $85^{\circ}$  C
- 6 relays, SPDT
- 2 relays, SPST
- Dry contact
- Relays field replaceable
- Switch transducers, audio and power
- Readback capability
- 5V operation

### DESCRIPTION

This general purpose relay card contains six SPDT relays and two SPST relays. The dry contacts are suitable for switching transducers, temperature sensors, low level signals and low power levels.

The relays are socketed and are field-replaceable. The contacts are terminated with a terminal block. Isolation between relays and the card circuitry is 500V.

The contacts are rated at 0.25A or 3W, whichever is higher. Contacts are rated to 100 VDC but operation is not recommended above 32V AC or DC for operator safety reasons. The contact status of the relays can be read at any time. There are no fuses on the cards, and the relays may be replaced in the field without the use of any special tools.

### Access indication

Each relay has a green LED annunciator that lights when a relay is energized. An amber LED lights briefly when the card is accessed. The status of the relays may be read at any time.

### Card address selection

The 5610 has jumpers to select one of eight I/O address blocks. Multiple cards can be used in the same system.

### Software library

Software drivers are available in QuickBASIC, C and PASCAL.

## TECHNICAL SPECIFICATIONS

**POWER SPECIFICATIONS**  
5V  $\pm$ 5% at 35 mA, no relays energized  
5V  $\pm$ 5% at 220 mA, all relays energized

**OPERATING TIME**  
Pick up time: 0.5 mS typ.  
Drop out time: 1.0 mS typ.

**ENVIRONMENTAL**  
-40° to 85° C operating  
-55° to 90° C nonoperating  
RH 5% to 95%, noncondensing

**ORDERING INFORMATION**  
#2630 5610 Reed Relay Card

## CONNECTOR PINOUTS

Terminal block connections		
Function		Pin #
Relay 0	NC	1
	Com	2
	NO	3
Relay 1	NC	4
	Com	5
	NO	6
Relay 2	NC	7
	Com	8
	NO	9
Relay 3	NC	10
	Com	11
	NO	12
Relay 4	NC	13
	Com	14
	NO	15
Relay 5	NC	16
	Com	17
	NO	18
Relay 6	Com	19
	NO	20
Relay 7	Com	21
	NO	22

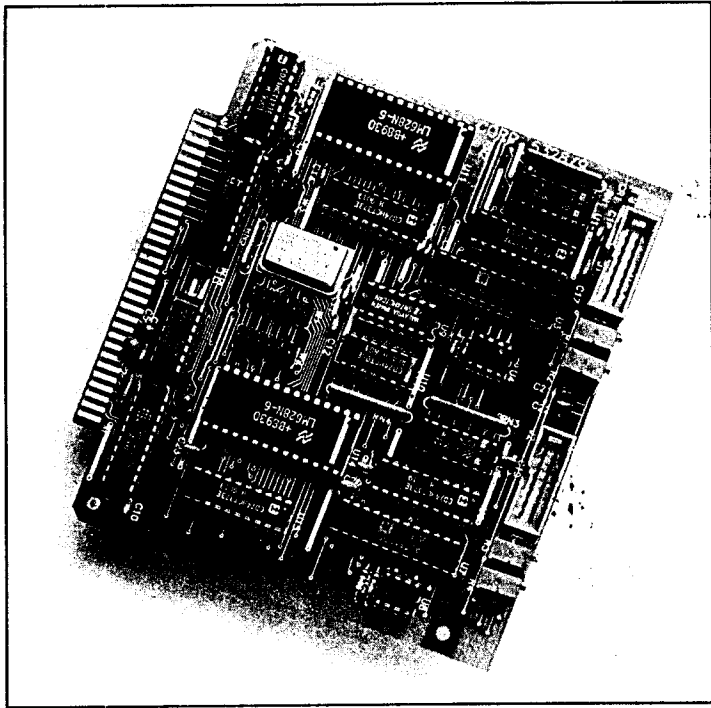

*Shown is the two-channel 5328-2 card.*

## 5328/9 MOTION CONTROL CARDS

### FEATURES

- -20° to 70° C
- 1 or 2 channels
- 32-bit position, velocity and acceleration registers
- Programmable digital PID filter with 16-bit coefficients
- Programmable derivative sampling interval
- 12-bit DAC output (5328)
- PWM output (5329)
- Internal trapezoidal velocity profile generator
- Parameters may be changed during motion
- Position and velocity modes
- Quadrature encoder interface with differential or single-ended inputs

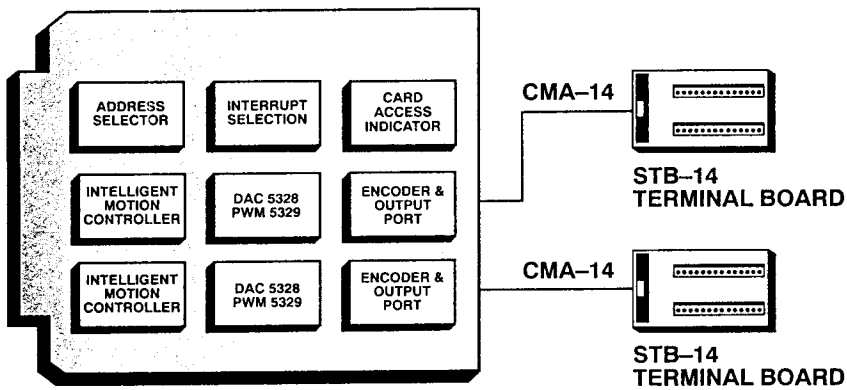

## DESCRIPTION

The 5328 and 5329 are complete motion control units. It accepts position signals from a quadrature encoder, computes a PID algorithm and provides an analog control signal to the motor controller. The 5328/9 has one channel and the 5328/9-2 has two channels. The 5328/9 use the National Semiconductor LM 628/629 processor chips, which provide continuous control independent of the system CPU.

The Control Card in the system initially writes the set of control conditions to the 5328/9. The on-card intelligent controller then maintains control of the motor without burdening down the Control Card.

The 5328/9 was designed specifically for controlling DC and brushless DC servomotors. The card can control any servomechanism that provides a quadrature, incremental feedback signal. The 5328/9 can also be used to monitor position and velocity values of a mechanism. The host Control Card can read the position and velocity registers on the 5328/9. This will allow the Control Card to display position and velocity "on the fly." The 5328/9 can also interrupt the Control Card to report conditions such as "move is complete" and "excessive position error detected."

### Motor position and timing

The internal trapezoidal profile generator computes the desired position of the motor versus time. Acceleration and deceleration occur automatically.

## Programming

Programming of the 5328/9 is done via a series of I/O commands in any language, including assembly code.

### Access indication

The 5328/9 has a LED indicator that flashes briefly when the card is accessed. This is useful when debugging software.

### Card address selection

The 5328/9 has jumpers to select one of eight I/O address blocks. Multiple cards can be used in the same system.

### Software library

Software drivers are available in QuickBASIC, C and PASCAL.

## TECHNICAL SPECIFICATIONS

### OUTPUT VOLTAGE

±10V (5328)  
0-5v (5329)

### OUTPUT CURRENT

29 mA (5328)  
3 mA (5329)

### POWER SPECIFICATIONS

5V ±5% at 120 mA  
(220 mA for 2 channels)  
5328 only: ±12V ±5% at 20 mA  
(40 mA for 2 channels)

### ENVIRONMENTAL

-20° to 70° C operating  
-40° to 85° C nonoperating  
RH 5% to 95%, noncondensing

### ACCESSORIES

STB-14 terminal board  
CMA-14 cable

### ORDERING INFORMATION

#2771 5328 Motion control card (DAC),  
1-channel  
#2644 5328-2 Motion control card  
(DAC), 2-channel  
#2772 5329 Motion control card (PWM),  
1-channel  
#2773 5329-2 Motion control card  
(PWM), 2-channel  
CMA-14-xx cable

## CONNECTOR PINOUTS

5328/29 I/O			
Funct.	Pin #	Funct.	Pin #
+5V	1	Ch. A-	8
+5V	2	Ch. B+	9
Gnd	3	Ch. B-	10
Gnd	4	Index +	11
PWM sign	5*	Index -	12
PWM mag.	6*	DAC out	13**
Ch. A+	7	DAC gnd	14**
*5329 only		**5328 only	

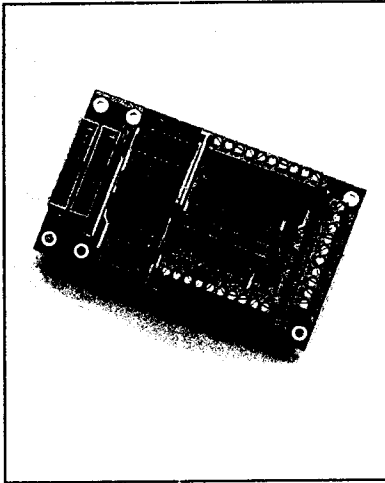

### HIGH VOLTAGE INTERFACE BOARDS

The ITB-16/8 and ITB-8/16 interface boards allow logic level (0-5V) lines to interface with PLCs and other devices with 3V to 24V logic. Inputs are protected against transients to  $\pm 30V$ . Outputs drive loads up to 50V at 250 mA. Status LEDs are included.

The ITB-16/8 has 16 inputs and eight outputs while the ITB-8/16 has eight inputs and 16 outputs. Screw terminals allow easy connection to field wiring. Both models connect to any 26-pin digital port with a CMA-26 cable. Two 26-pin IDC connectors are provided so that other devices may be daisy-chained with other I/O devices.

#### SIZE

3.0 in. x 5.0 in. x 0.5 in.  
4 mounting holes.

#### POWER REQUIREMENTS

5V  $\pm 5\%$  at 10 mA to 120 mA

#### ENVIRONMENTAL

-40° to 85° C operating  
-55° to 90° C nonoperating

#### ORDERING INFORMATION

#3039 ITB-16/8  
#3037 ITB-8/16

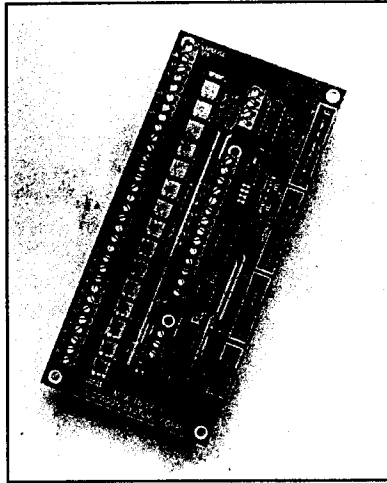

### MUX-16 EXPANDS ANALOG INPUTS

The MUX-16 adds 15 channels to the 5710 I/O card. All inputs can withstand an overload voltage of 120 VAC indefinitely. Up to 16 MUX-16 cards may be daisy-chained so that the number of analog inputs can be expanded to 256.

The analog input channels are terminated with screw terminals. The digital lines for multiplexing connect to the control computer via a CMA-26 cable. Another 26-pin socket is provided so that the remaining 20 digital I/O lines in this cable may be used for other purposes.

#### SIZE

3.3 in. x 7.1 in. x 0.5 in.  
6 mounting holes.

#### POWER REQUIREMENTS

5V  $\pm 5\%$  at 100 mA

#### ENVIRONMENTAL

-40° to 85° C operating  
-50° to 90° C nonoperating

#### ORDERING INFORMATION

#2949 MUX-16

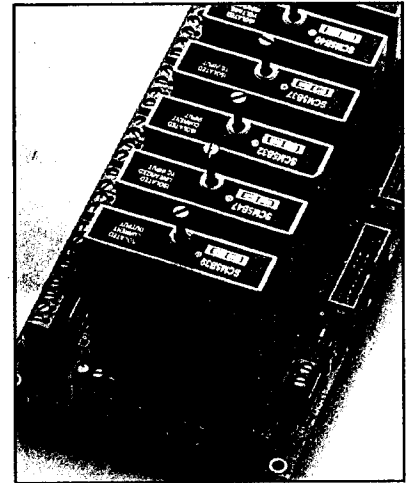

### ANALOG SIGNAL CONDITIONING BOARD

The AIN-5B provides a high quality, isolated interface for analog inputs. 5B signal conditioning modules accept signals from thermocouples, RTDs, strain gauges, millivolt, volt and current sources. The output modules can provide 4-20 mA or 0-20 mA current.

The AIN-5B board can accept up to four input modules and two output modules. All unused channels are terminated with a separate screw terminal strip for non-isolated inputs. The AIN-5B is compatible with the 5710 card.

**NOTE:** See page 119 for module manufacturers. The 5B modules are not available from Octagon.

#### SIZE

3.9 in. x 6.7 in. Maximum height with modules installed is 2.5 in.; 5 mounting holes.

#### POWER REQUIREMENTS

5V  $\pm 5\%$  at 30 mA per module

#### ENVIRONMENTAL

-30° to 80° C operating  
-40° to 85° C nonoperating  
RH 5% to 95%, noncondensing

#### ORDERING INFORMATION

#2943 AIN-5B board

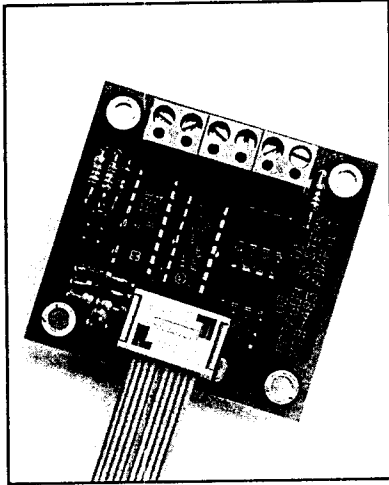

### RS-422/485 INTERFACE

The MTB-485 converts a serial port to RS-422 or RS-485. With two twisted pair the card can be located up to 4,000 ft. from the host. You can also parallel up to 32 units on a RS-485 multidrop network. Application notes are available from Octagon through the bulletin board (303-427-5358), or call Octagon for an applications disk (303-430-1500).

One remote may talk to the host at a time. The MTB-485 operation is automatic so that no software is required to turn the transmitter on and off. You simply write to the port as you would any RS-232C port.

#### SIZE

2.26 in. x 2.28 in. The maximum component height is 0.6 in. Mounting holes in each corner.

#### POWER REQUIREMENTS

5V  $\pm$ 5% at 45 mA. Supplied through serial cable when used with Micro PC serial ports.

#### ENVIRONMENTAL

-40° to 85° C operating

#### ORDERING INFORMATION:

#2751 MTB-485

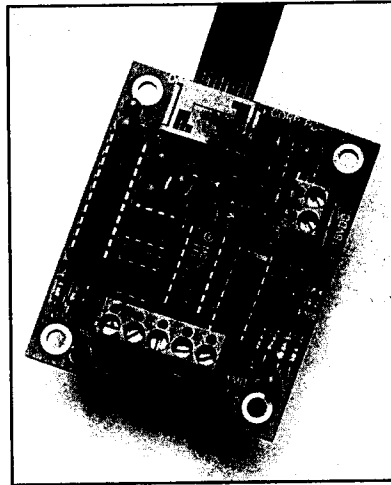

### RS-422/485 FOR THE PC

The PC-485 converts a serial port on your PC from RS-232 to RS-422 or RS-485. This is the companion card to the MTB-485 when the PC will be the host computer. Transmission distance is up to 4,000 ft.

Since operation of the transmitter is automatic, programs previously written on the PC will not need to be modified when using the PC-485. The PM-485 power module supplies the required power.

#### SIZE

2.55 in. x 2.1 in. The maximum component height is 0.6 in. Mounting holes in each corner.

#### ENVIRONMENTAL

-40° to 85° C operating, PC-485  
0° to 50° C operating, PM-485  
RH 5% to 95%, noncondensing

#### POWER REQUIREMENTS

9V to 16 VDC at 50 mA. Screw terminals accept "battery eliminator" type power supplies.

#### ORDERING INFORMATION

#2894 PC-485 converter  
#2973 PM-485 power module, 9 VDC

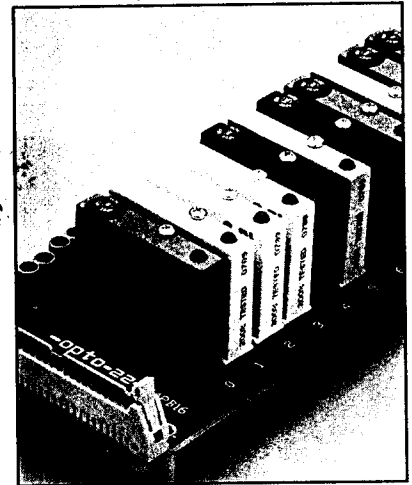

### OPTO MODULES

Opto-isolated modules are used for three primary purposes:

- 1) To prevent noise problems due to ground loops. Voltage differences between grounding points within a facility cause unwanted currents to flow. Using opto-isolated modules prevents ground current from flowing.
- 2) To eliminate direct connection from one system to another. This minimizes the possibility that a fault in one system will affect another system.
- 3) To extend the logic input/output capabilities to 260 VAC or VDC and 3A. Input modules can also be driven with signals as high as 260 VAC and VDC.

#### Miniature G4 modules

The miniature G4 modules have the same specifications as the previous generation, larger modules. The G4 modules have a built-in fuse and LED. When determining power requirements, add 12 mA for each module

#### ALL MODULES ARE:

UL recognized and CSA approved.  
Operating temperature: -30° to +70° C

**G4 INPUT MODULES**

<b>AC/DC input module G4-IAC5</b>	<b>AC/DC input module G4-IAC5A</b>	<b>DC input module G4-IDC5</b>
Control voltage: 5 VDC Input voltage range: 90-140 VAC/ VDC Input current: 8 mA max Input allowed for no output: 3 mA (45V) Isolation: 4000 Vrms Output leakage: 100 µA max Logic supply current: 10 mA Response time: 20 mS	Control voltage: 5 VDC Input voltage range: 180-280 VAC/ VDC Input current: 7 mA max Input allowed for no output: 2 mA (90V) Isolation: 4000 Vrms Output leakage: 100 µA max Logic supply current: 10 mA Response time: 20 mS	Control voltage: 5 VDC Input voltage range: 10-32VDC Input current: 30 mA max Input allowed for no output: 1 mA (3V) Isolation: 4000 Vrms Output leakage: 100 µA max Logic supply current: 10 mA Response time: 5 mS
<b>DC input module G4-IDC5B</b>	<b>DC input module G4-IDC5D</b>	<b>Output test module G4-SWOUT</b>
Control voltage: 5 VDC Input voltage range: 4-16 VDC Input current: 45 mA max Input allowed for no output: 0.7 mA (1V) Isolation: 4000 V rms Output leakage: 100 µA max Logic supply current: 12 mA Response time: 0.1 mS	Control voltage: 5 VDC Input voltage range: 2.5-28 VDC Input current: 30 mA max Input allowed for no output: 0.2 mA (1V) Isolation: 4000 V rms Output leakage: 10 µA max Logic supply current: 12 mA Response time: 1.5 mS	Simulates G4 module. output contact rating: 3 mA @ 250 VAC

**ORDERING INFORMATION**

- #2395 G4-IAC5, AC/DC input, 90-140V
- #2396 G4-IAC5A, AC/DC input,  
180-280V
- #2397 G4-IDC5, DC input, 15-32V
- #2511 G4-IDC5B, DC input, 4-16V
- #2529 G4-IDC5D, DC input, 2.5-28V
- #3012 G4-SWIN, switch input
  
- #2398 G4-OAC5, AC output 12-140V
- #2399 G4-OAC5A, AC output 24-280V
- #2400 G4-ODC5, DC output, 5-60V
- #2503 G4-ODC5A, DC output, 5-200V
- #3013 G4-ODC5R, dry contact output
- #3011 G4-SWOUT, switch output



**G4 OUTPUT MODULES**

<b>AC output module G4-OAC5</b>	<b>AC output module G4-OAC5A</b>	<b>DC output module G4-ODC5</b>
<p>Control voltage: 5 VDC                      Operating voltage range: 12-140 VAC                      Peak repetitive voltage: 600V                      Current rating @ 45°C: 3A                      Current rating @ 70°C: 2A                      1/2 cycle surge-peak: 100A                      Minimum load current: 50 mA                      Output voltage drop: 1.6V                      Min. off-state leakage: 2 mA rms                      Isolation voltage-                          input to output: 4000 Vrms                      Min. load current: 11 mA                      Response time: 1/2 cycle                      DV/DT off-state: 200 V/μS</p>	<p>Control voltage: 5 VDC                      Operating voltage range: 24-280 VAC                      Peak repetitive voltage: 600V                      Current rating @ 45°C: 3A                      Current rating @ 70°C: 2A                      1/2 cycle surge-peak: 100A                      Minimum load current: 50 mA                      Output voltage drop: 1.6V                      Off-state leakage: 5 mA rms                      Isolation voltage-                          input to output: 4000 Vrms                      Control input current: 11 mA                      Operating frequency: 25-65 Hz                      Response time: 1/2 cycle                      DB/DT off-state: 200 V/μS</p>	<p>Control voltage: 5 VDC                      Operating voltage range: 5-60 VDC                      Current rating @ 45°C: 3A                      Current rating @ 70°C: 2A                      1 second surge: 5A                      Output voltage drop: 1.0V max                      Off-state leakage: 1 mA                      Isolation voltage-                          input to output: 4000 Vrms                      Control input current: 10 mA                      Response time: 11/40 mS</p>
<b>DC output module G4-ODC5A</b>	<b>DC dry contact output G4-ODC5R</b>	<b>Input test module G4-SWIN</b>
<p>Control voltage: 5 VDC                      Operating voltage range: 5-200 VDC                      Current rating @ 45° C: 1A                      Current rating @ 70° C: 0.55A                      One-second surge: 5A                      Output voltage drop: 1.6V                      Min. off-state leakage: 2 mA                      Isolation voltage-                          input to output: 4000 Vrms                      Control input current: 12 mA                      Response time: 100/750 μs</p>	<p>Control voltage: 5 VDC                      Control form: SPST-normally open                      Contact rating: 10 VA                      Contact current: 0.5A                      Response time: 0.5 mS                      Isolation voltage: 1500 VDC                      Logic supply current: 14 mA</p>	<p>Simulates an external input.                      Built-in LED indicator.                      Logic supply current: 14 mA</p>





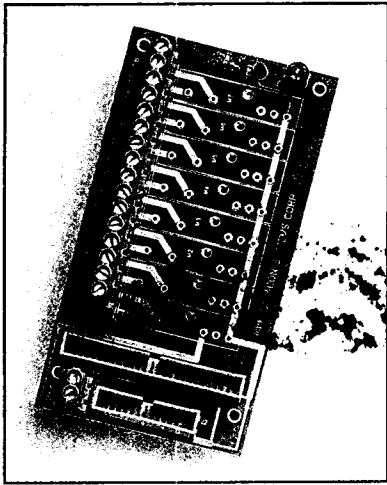

*MPB-08 opto rack*

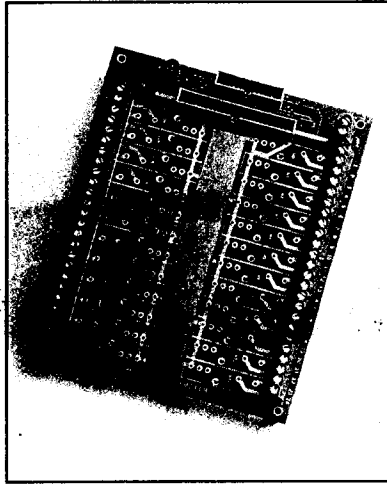

*MPB-24 opto rack*

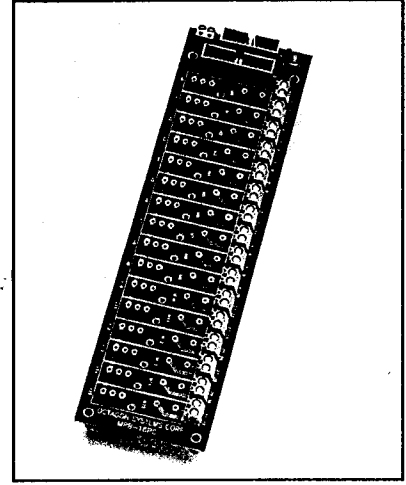

*MPB-16PC opto rack*

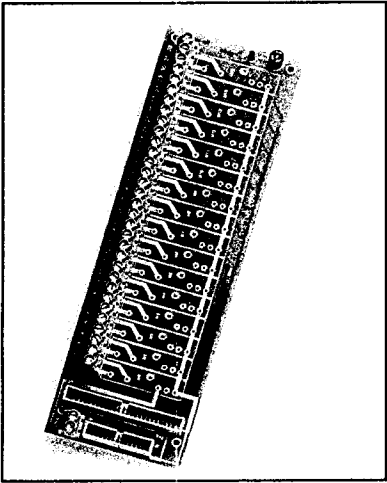

*MPB-16 opto rack*

#### **MPB OPTO RACKS**

The MPB series holds 8, 16 or 24 G4 opto modules. Heavy duty field terminal blocks will accept up to 12 gauge wiring. Module racks interface directly with parallel ports on the Micro PC Control and expansion cards via a CMA-26 cable. Racks have a 50-pin connector for use with existing 50-conductor cables. The cable pinout conforms to the industry standard supported by Opto 22, Gordos, P&B, Grayhill, and others.

#### **SIZE**

Height with modules for all racks: 2.5 in.  
MPB-08: 6.0 in. x 3.25 in.  
MPB-16: 10.0 in. x 3.25 in.  
MPB-24: 7.5 in. x 6.25 in.

#### **ORDERING INFORMATION**

#2512 MPB-08, 8-channel  
#2513 MPB-16, 16-channel  
#2514 MPB-24, 24-channel  
CMA-26-xx cable

#### **MPB-16PC**

Now you can control high voltage/high current lines directly from the printer port of your desk top PC or Micro PC Control card via the MPB-16PC. This rack has 16 positions and is compatible with any bi-directional printer port. A software library for C and QuickBASIC is provided. Use the 60-in. VTC-5 cable with your PC and the CMA-20 cable with the Micro PC.

#### **SIZE**

Height with modules: 2.5 in.  
MPB-16PC: 9.5 in. x 2.8 in.

#### **ORDERING INFORMATION**

#3389 MPB-16PC, 16-channel  
CMA-20-xx cable.