

BAND	TUNING RANGE
1	.54 - 1.4 MC
2	1.4 - 3.3 MC
3	3.2 - 5.6 MC
4	5.4 - 9.7 MC
5	9.4 - 17.8 MC
6	17.3 - 31.5 MC

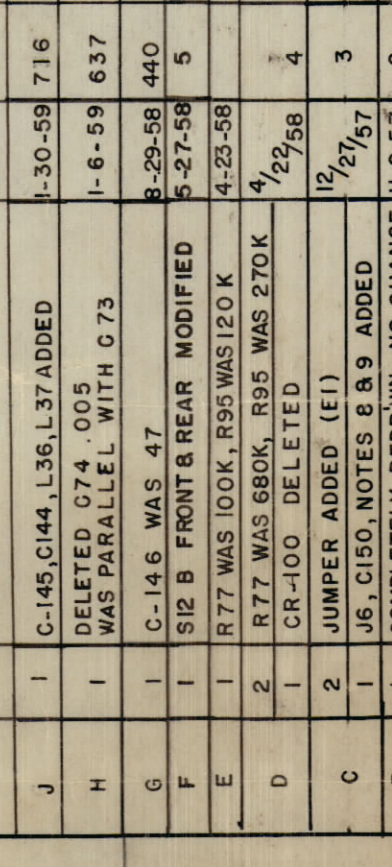
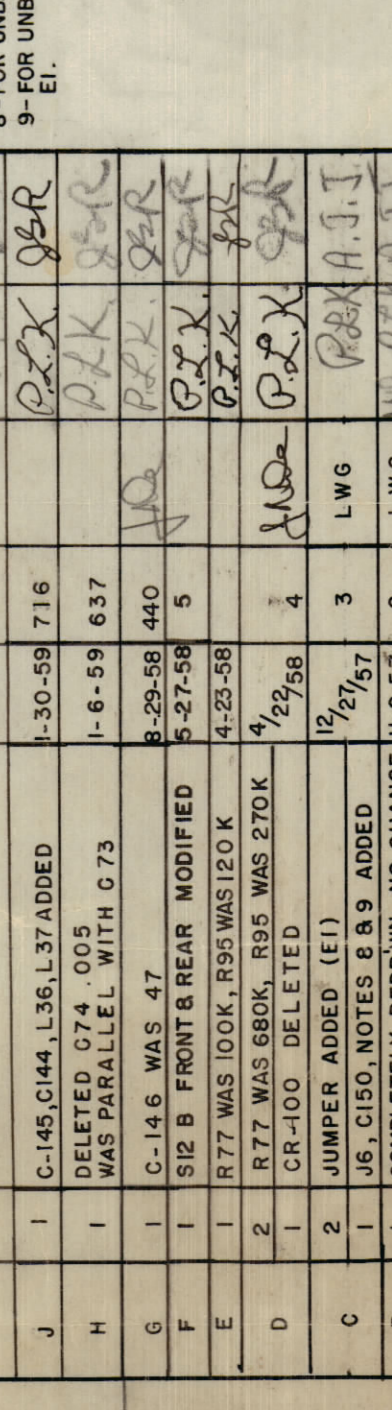
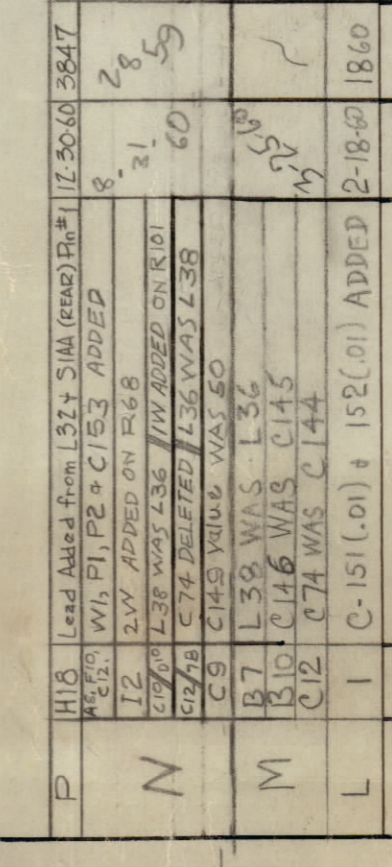
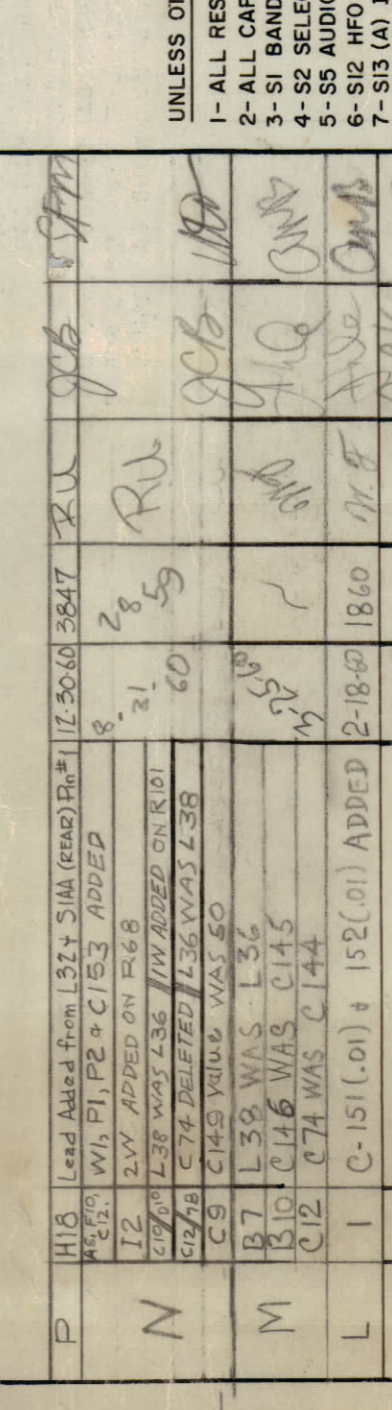
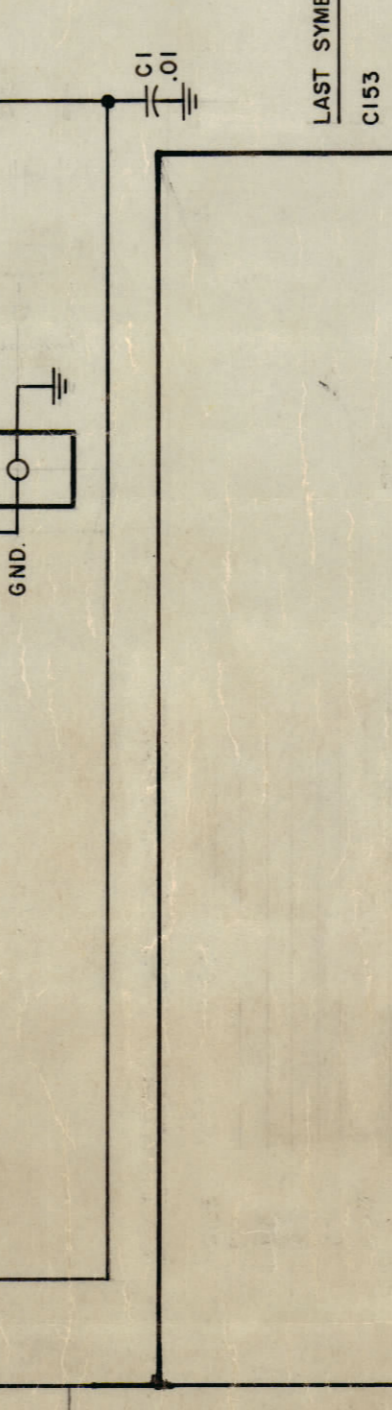
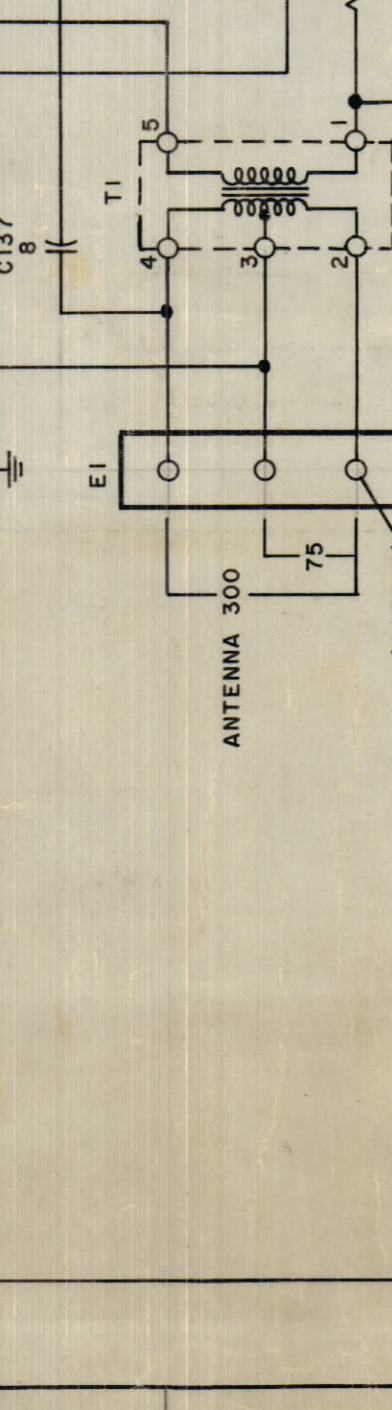
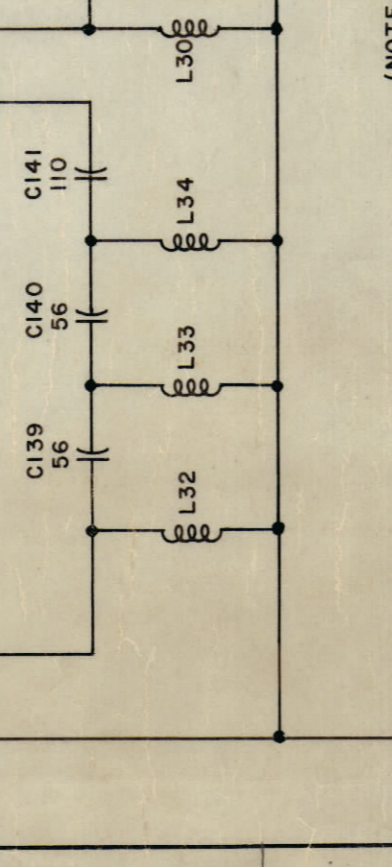
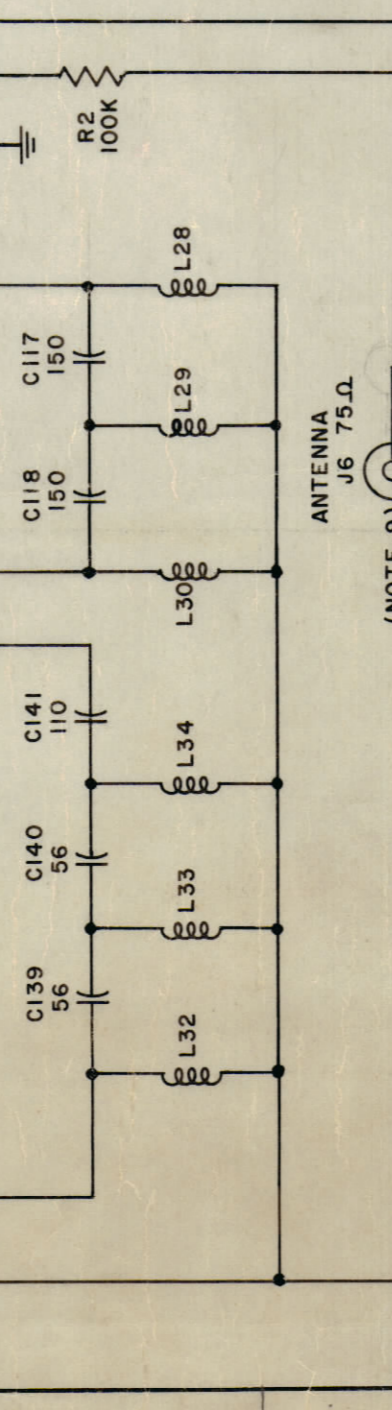
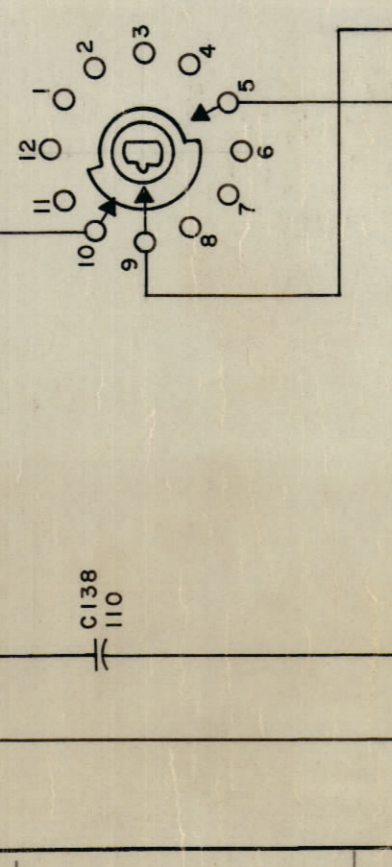
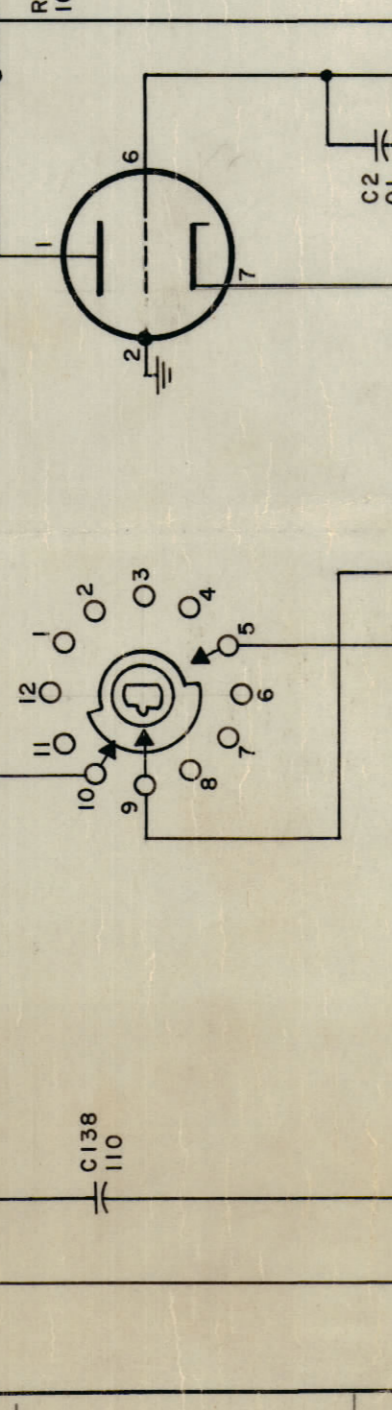
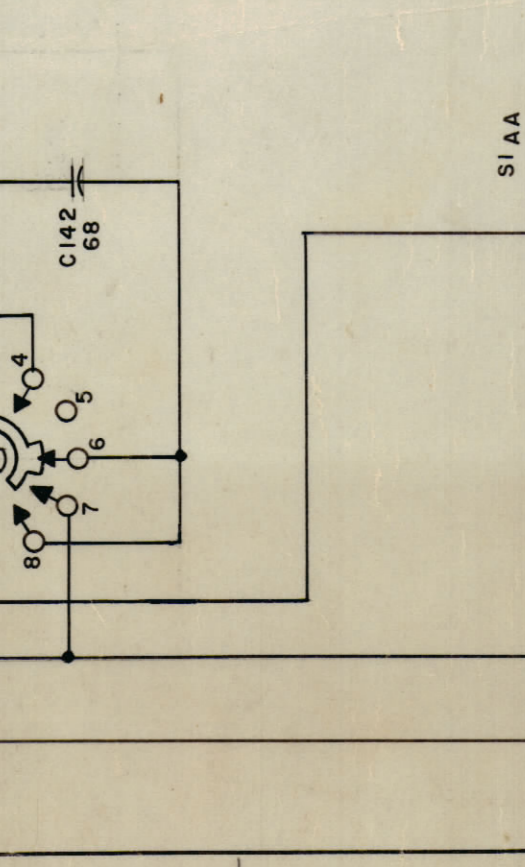
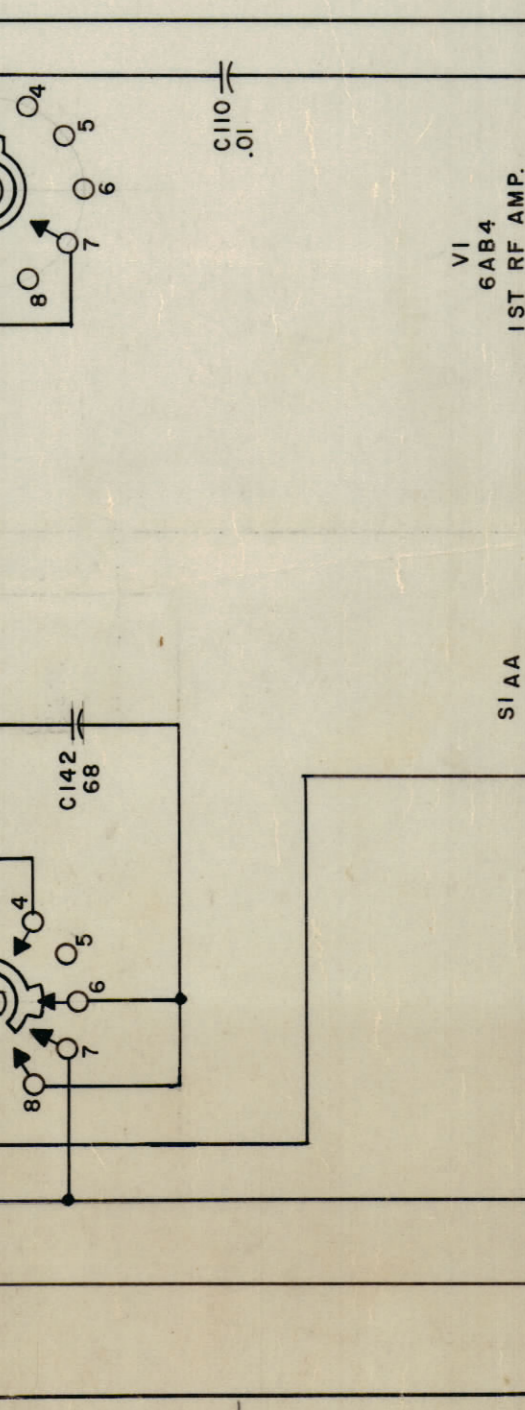

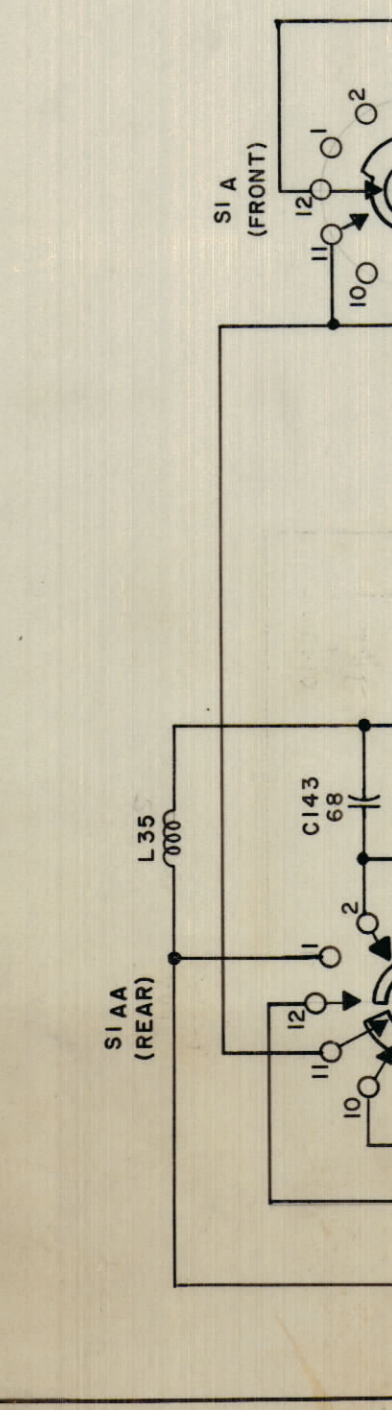
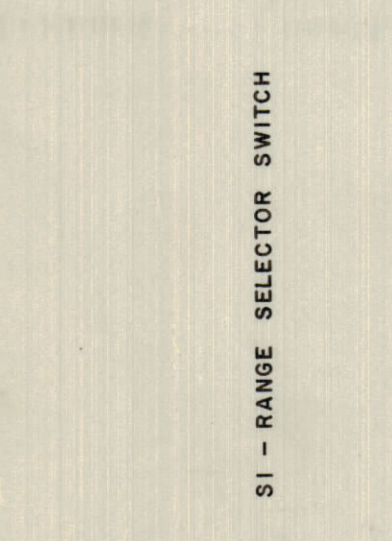

ISSUE	ITEM	REVISION	DATE	BY	CHK'D	APP.
1	1	1	11/17/57	W.G.		
2	1	1	11/17/57	W.G.		
3	1	1	11/17/57	W.G.		
4	1	1	11/17/57	W.G.		
5	1	1	11/17/57	W.G.		
6	1	1	11/17/57	W.G.		
7	1	1	11/17/57	W.G.		
8	1	1	11/17/57	W.G.		
9	1	1	11/17/57	W.G.		
10	1	1	11/17/57	W.G.		
11	1	1	11/17/57	W.G.		
12	1	1	11/17/57	W.G.		
13	1	1	11/17/57	W.G.		
14	1	1	11/17/57	W.G.		
15	1	1	11/17/57	W.G.		
16	1	1	11/17/57	W.G.		
17	1	1	11/17/57	W.G.		
18	1	1	11/17/57	W.G.		

THE TECHNICAL MATERIEL CORP.  
MAMARONECK, NEW YORK  
SCHEMATIC DIAGRAM  
MODEL GPR-90-RX  
DRAWN BY W.G.  
CHECKED BY J.T.  
FINAL APPROVAL BY W.G.  
TELEC. DES. CK-345P