

STATIC PRESSURE IN H₂O

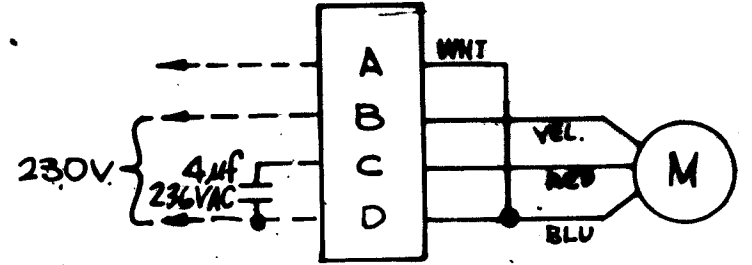
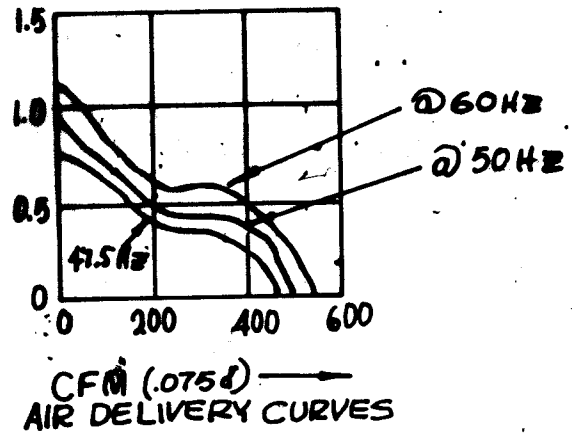

REVISIONS

SYM	DESCRIPTION	DATE	E.M.N. NO.	DRAFT	BY	APP
X	EXP. RELEASE	3-7-67				
B	ORIGINAL RELEASE FOR PRODUCTION	4-7-67	Ø	CV		
A	ADDED SCREEN GUARD & HARDWARE	12-18-67	18674	N.S.		FB
B	TITLE BLOCK WAS (1) FLANGE	6.3.68	18946	HAZ		FB

BL129

(8) 7/32 DIA. HOLES EQUALLY SPACED 45° APART ON A 4" RADIUS.

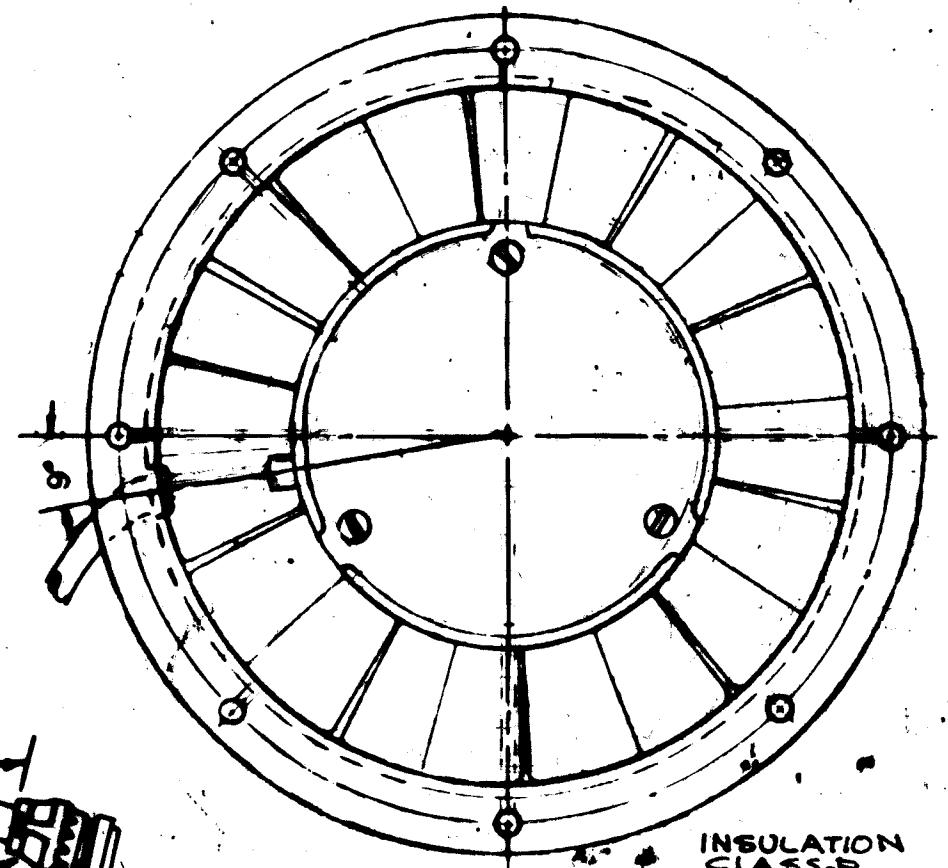
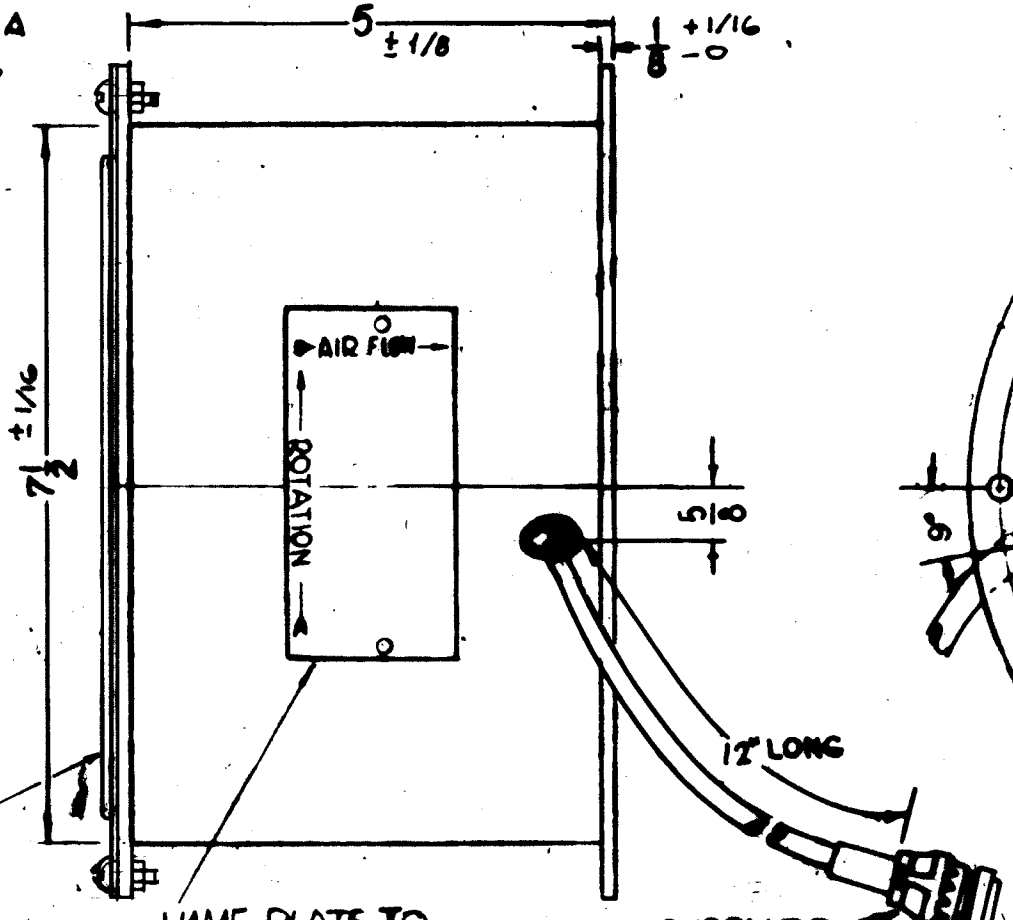
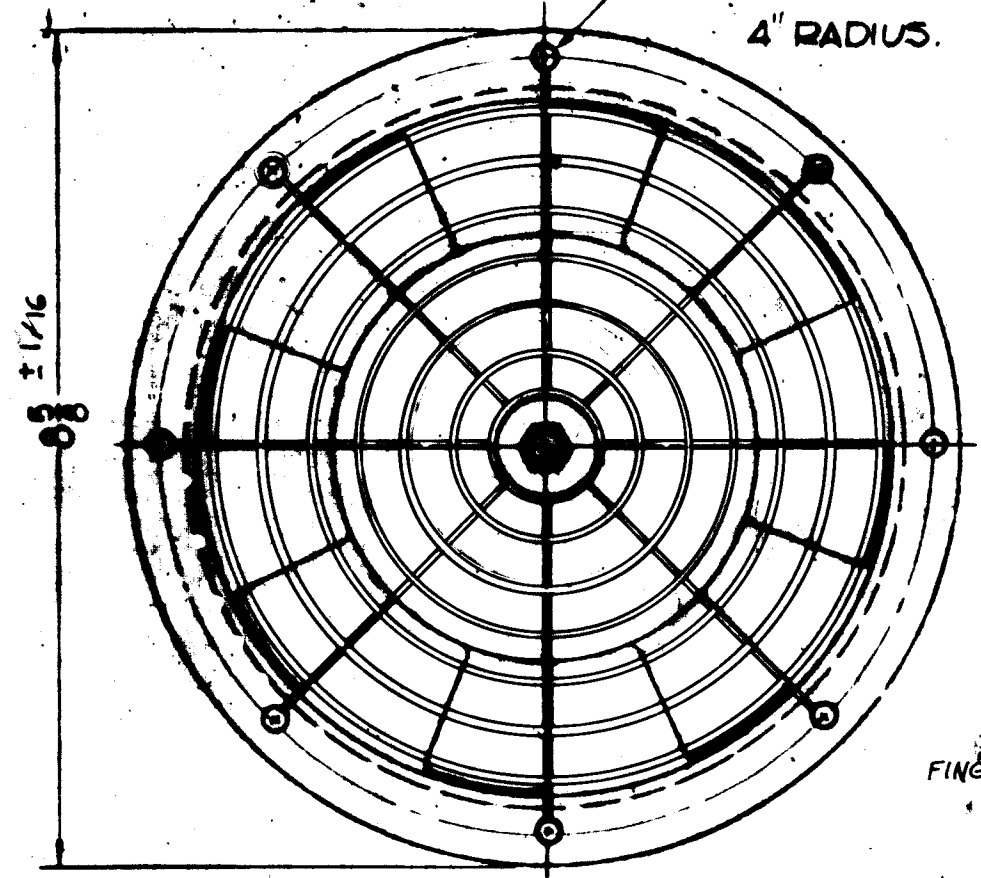

NAME PLATE TO INCLUDE TMC BL129 - W/LATEST REV. LETTER.

SUPPLIED BY MFG.

SPECIFICATIONS:

MOTOR ~ AC
 VOLTS ~ 230 ± 10%
 PH ~ 1
 FREQ. ~ 47.5 TO 63 Hz (CPS)
 CAPACITOR ~ 4 μF 236 VAC
 SPEED ~ 2600/3300
 CURRENT ~ 0.85/0.6 A

NOTES

DATA TABLE

V	Hz	RPM	CURRENT	WATTAGE
208	60	3300	.5 AMP	100 WATT
208	50	2890	.4 AMP	70 WATT

1	RAK-110-2	BMA156
1	RAK-111-2	BMA158
SCALE	1/2:1	CODE
		S401-116
		BC3810V-0-2

THE CONTENTS OF THIS DRAWING ARE THE EXCLUSIVE PROPERTY OF THE TECHNICAL MATERIEL CORP. ITS UNAUTHORIZED USE OR REPRODUCTION IN WHOLE OR IN PART IS STRICTLY FORBIDDEN.

REQ'D.	ITEM	PART NUMBER	DESCRIPTION	SYMBOL
	F. BUDETTI		LIST OF MATERIAL	
	MATERIAL		THE TECHNICAL MATERIEL CORP. MAMARONECK, NEW YORK	
			TITLE FAN, VANE AXIAL (2 FLANGE)	
			UNLESS OTHERWISE SPECIFIED DIMENSIONS ARE IN INCHES AND INCLUDE CHEMICALLY APPLIED OR PLATED FINISHES	
			FINISH SEMI-GLOSS BLK ENAM. IMPELLER-BLK ANODIZE	
			TOLERANCES ± .005 ± .01 ± .005	
			DATE 3-7-67	
			BY [Signature]	
			BL129	B

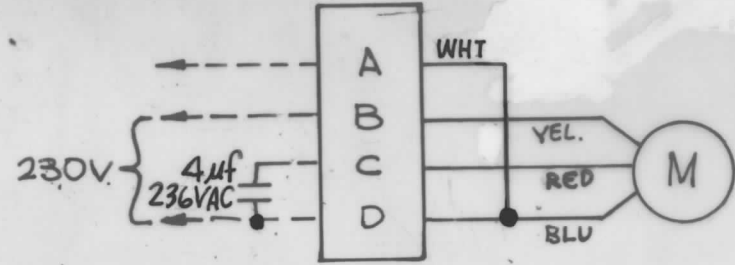
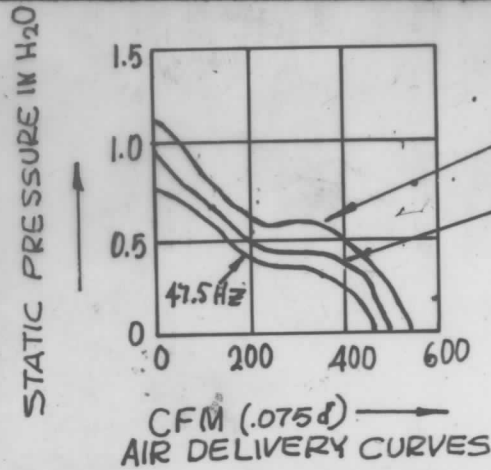

REVISIONS

SYM	DESCRIPTION	DATE	E.M.N. NO.	DRAFT	CHKD	APPD
X	EXP. RELEASE	3-7-67				
Ø	ORIGINAL RELEASE FOR PRODUCTION	4-7-67	Ø	CV		
A	ADDED SCREEN GUARD & HARDWARE	12-18-67	18674	H.S.		FBA
B	TITLE BLOCK WAS (1) FLANGE	6.3.68	18946	H.S.		FB

BL129

(8) 7/32 DIA. HOLES EQUALLY SPACED 45° APART ON A 4" RADIUS.

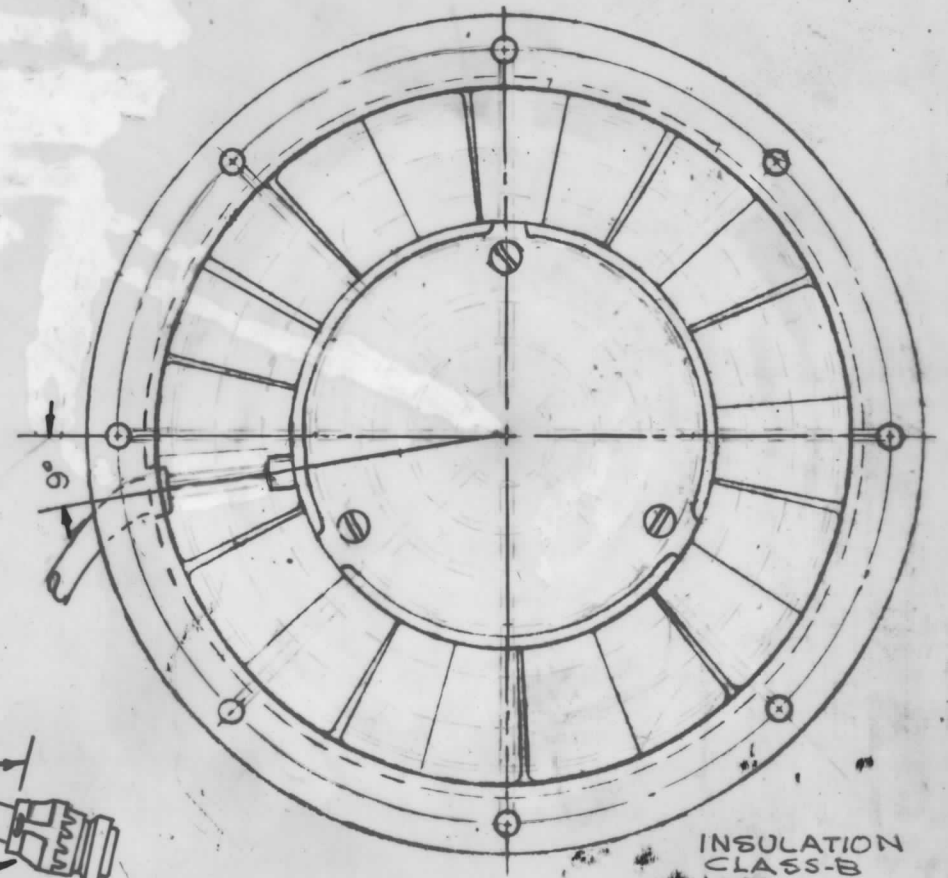
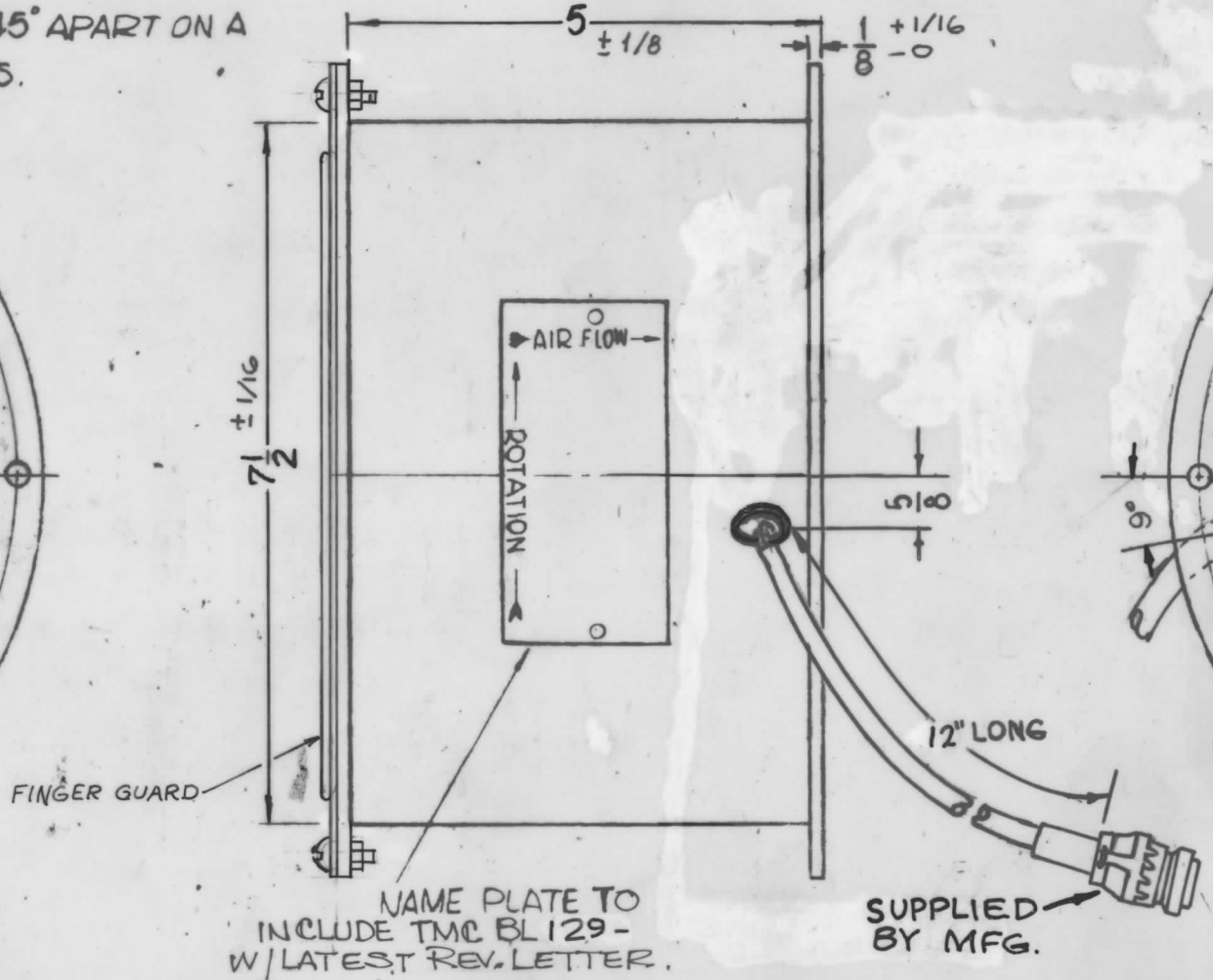
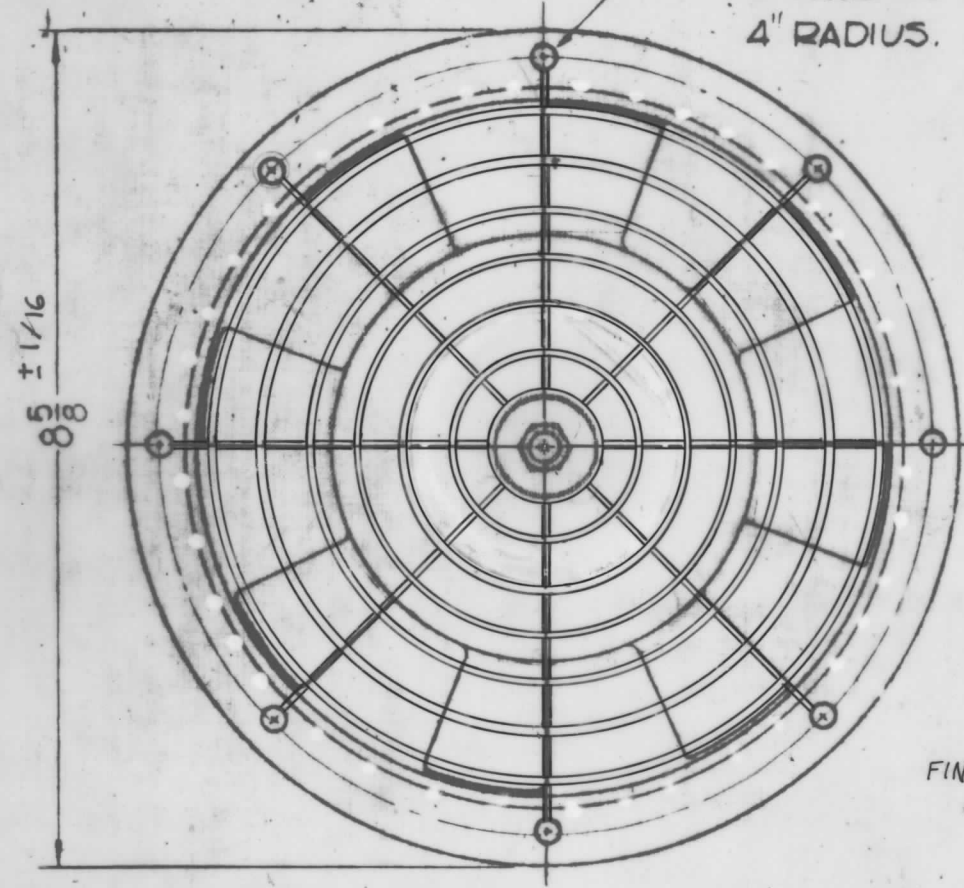

SPECIFICATIONS:

MOTOR ~ AC
 VOLTS ~ 230 ± 10%
 PH ~ 1
 FREQ. ~ 47.5 TO 63 Hz (CPS)
 CAPACITOR ~ 4µF 236 VAC
 SPEED ~ 2600/3300
 CURRENT ~ 0.85/0.6A

DATA TABLE

V	Hz	RPM	CURRENT	WATTAGE
208	60	3300	.5 AMP	100 WATT
208	50	2890	.4 AMP	70 WATT

REQ'D.	ITEM	PART NUMBER	DESCRIPTION	SYMBOL
LIST OF MATERIAL				
F. BUDETTI			THE TECHNICAL MATERIEL CORP. MAMARONECK, NEW YORK	
MATERIAL			FAN, VANEAXIAL (2 FLANGE)	
FINISH			TITLE	
SEMI-GLOSS BLK ENAM.			DRAWN	
IMPELLER-BLK ANODIZE			CHECKED	
UNLESS OTHERWISE SPECIFIED			DATE	
DIMENSIONS ARE IN INCHES AND INCLUDE			FINAL APPROVAL	
CHEMICALLY APPLIED OR PLATED FINISHES			DATE	
DECIMALS			ELECT. DES.	
.X ± .05			MECH. DES.	
.XX ± .01			SHEET	
.XXX ± .005			REV. LTR.	
FRACTIONS			DATE	
± 1/64			DATE	
TOLERANCES			DATE	
ANGLE			DATE	
± 0° 30'			DATE	

NOTES

THE CONTENTS OF THIS DRAWING ARE THE EXCLUSIVE PROPERTY OF THE TECHNICAL MATERIEL CORP. ITS UNAUTHORIZED USE OR REPRODUCTION IN WHOLE OR IN PART IS STRICTLY FORBIDDEN.